

All you want to know about the BBC MICRO!

# THE MICRO USER

Volume 1  
Number 6  
August 1983  
£1

**WIN**



this PL Digitiser in another challenging contest – Page 41

Use your micro to control the world

Put more animation into your programs

Explore the inside of King Kong

Fight fearsome Fruities

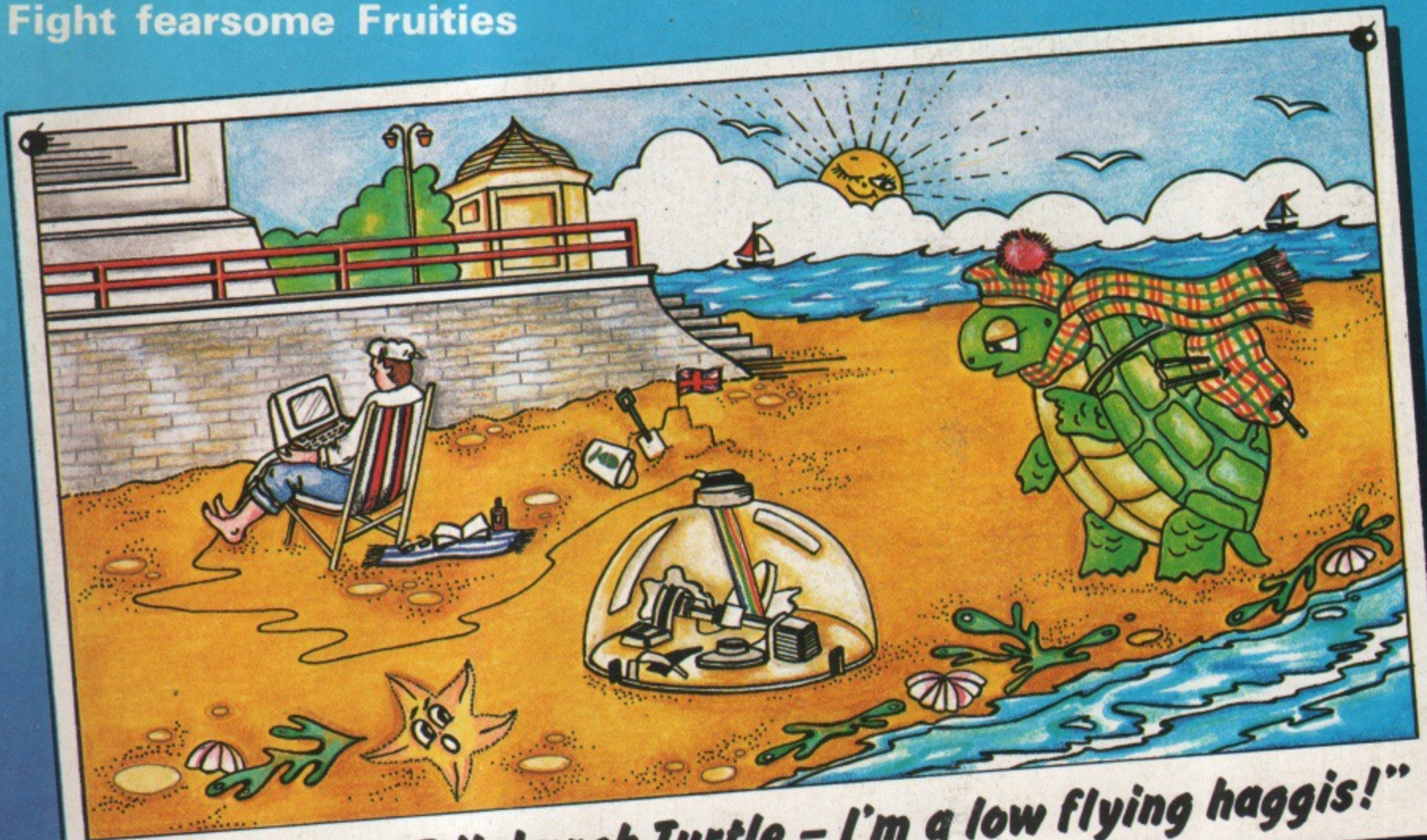

*"If you're an Edinburgh Turtle – I'm a low flying haggis!"*

**INSIDE**  
Pull-out Guide  
to software for  
the BBC Micro  
Part 3

## TALKING TURTLES!

We put two rival BBC robots through their paces – Page 26

# 32K BBC ALL O.S.'s



**PAINTER** Written entirely in machine code this fast arcade style game features sixteen different screen presentations and six skill levels which make the game harder as you get better. **£8.00**

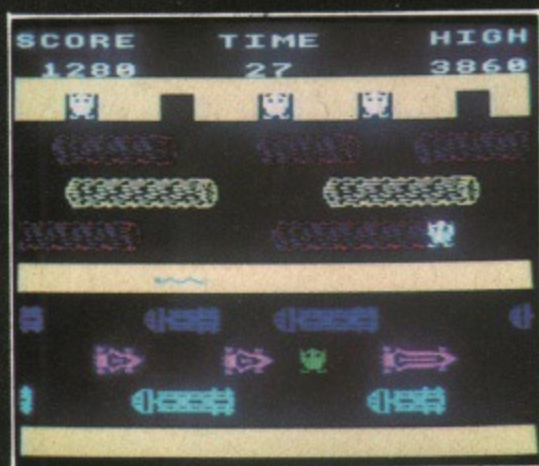

**PLANES** Another A&F machine code special. Select either 'fast' or 'slow' and stand by your keyboard for action. Hi-score tables and brilliant graphics. **£8.00**

**FROGGER** Also written in machine code this is a frustrating exercise in crossing the road, fording a river and trying for extra points by picking up the lady frog. Beware of the snake and don't forget the crocodile! **£8.00**



**TOWER OF ALOS** An excellent adventure game which has the feature of saving your character if you fall to. Also for the Model A.

**PHARAOH'S TOMB** The interactive adventure game for the BEEB. Pick up the gold pieces, fight the spider and be scared penniless by the mummy. Work out the magic words and you are on your way. **£8.00**

**LUNAR LANDER** One of our old favourites and still just as difficult to get down in one piece. **£6.90**

ALL BBC PROGRAMS AVAILABLE ON DISC AT **£11.50** EACH.

AVAILABLE FROM ALL GOOD SOFTWARE HOUSES OR DIRECT FROM

## A + F SOFTWARE

830 HYDE ROAD, MANCHESTER M18 7JD

061-223 6206 TELEX 667461 (Attn. A + F)

# THE BEST BBC MICRO SOFTWARE

PRODUCED BY AN INDEPENDENT SOFTWARE HOUSE

— TOP QUALITY MACHINE-CODE PROGRAMS —

# BBC

**SPECIAL OFFER!**  
Deduct £1 per cassette or disc when ordering 2 or more.



**CENTIPEDE (32K) £7.95 Cassette**  
Incredible arcade type game featuring mushrooms, snails, flies, spiders and the centipedes of course. Excellent graphics and sound. 6 skill levels, hi-score, rankings, bonuses, and increasing difficulty as the spiders become more active and the number of mushrooms increases.

*"Visually this game compares well with the arcade version, being colourful and clear."*

... YOUR COMPUTER



**FROGGER (32K) £7.95 Cassette**  
Not just another version of Frogger... this is the proper high-quality version that you've been waiting for. Graphically brilliant, with gaping-mouthed crocodiles, diving turtles, and frogs that flex their legs as they jump along. Increasing difficulty, hi-score, responsive controls, sound effects, flies and bonus frogs.

●●● NEW RELEASE ●●●



**ROAD RUNNER (32K) £7.95 Cassette**  
The only full feature machine-code version of the arcade game available for the B.B.C. micro. Features include: scrolling screen, radar display, check-point flags, fuel gauge, smoke screens, 6 skill levels, rankings, increasing difficulty, and sound effects.

Suitable for use with keyboard or joysticks.

●●● NEW RELEASE ●●●



**ALIEN DROPOUT (32K) £7.95 Cassette**  
Based upon the arcade game of ZYGON, but our version improves upon the original arcade game itself. You have to shoot the aliens out of their "boxes" before the "boxes" fill up. Once full, the aliens fly down relentlessly, exploding as they hit the ground. Suitable for use with keyboard or joysticks.

*"Do not be fooled by their placid appearance - these moths are out to get more than the clothes in your wardrobe."* ... YOUR COMPUTER



**SPACE FIGHTER (32K) £7.95 Cassette**  
Arcade-style game based upon features from DEFENDER and SCRAMBLE. 5 types of menacing alien fire at you and may attempt to ram you. Separate attack phases, fuel dumps, repeating laser cannon, asteroids, smart bombs, hi-score, rankings, 6 skill levels, sound effects.

*"A thoroughly enjoyable program, well worth the money..."*  
... HOME COMPUTING WEEKLY.



**GALAXIANS (32K) £7.95 Cassette**  
Fast action version of the popular arcade game. 4 types of Galaxian (in 3 initial screen formations) swoop down individually or in groups of two or three. 6 skill levels, high score, rankings, bonus laser bases and increasing difficulty. Superb sound effects and graphics.

*"Both... are well-produced, with colourful graphics, responsive controls and the usual bunch of extra-terrestrials..."* ... YOUR COMPUTER



**INVADERS (32K) £7.95 Cassette**  
Superb version of the old classic arcade game, including a few extras. 48 marching invaders drop bombs that erode your defences, and two types of spaceship fly over releasing large bombs that penetrate through your defences. Increasing difficulty, high score, superb graphics and sound.



**FRUIT MACHINE (32K) £7.95 Cassette**  
Probably the best fruit machine implementation on the market. This program has it all... HOLD, NUDGE, GAMBLE, spinning reels, realistic fruits and sound effects, multiple winning lines. This is THE fruit machine program to buy.

*"The graphics are very good and with a little imagination you might be able to convince yourself you are in Las Vegas."*  
... YOUR COMPUTER

**DEALERS ... DEALERS ... DEALERS ... DEALERS ... DEALERS ...**

All our programs are available at all good dealers including:-  
ELTEC COMPUTERS, 217, Manningham Lane, Bradford.  
BUCON LIMITED, 18 Mansel Street, Swansea.  
WEST COAST PERSONAL COMPUTERS, 47 Kyle Street, Ayr.  
BYTEWARE LIMITED, Unit 25, Handyside Arcade, Newcastle.  
MICROSTYLE, 29 Belvedere, Lansdown Road, Bath.

MICROSTYLE, 47 Cheap Street, Newbury, Berks.  
SIR COMPUTERS LTD., 91 Whitechurch Road, Cardiff.  
ELECTRONEQUIP, 36-38 West Steet, Fareham, Hants.  
MICRO MANAGEMENT, 32 Princes Street, Ipswich.  
3D COMPUTERS, 230 Tolworth Rise South, Tolworth, Surbiton, Surrey.

+ MORE THAN 30 OTHER DEALERS IN THE U.K. AND OVERSEAS.

**WE PAY 25% ROYALTIES FOR HIGH QUALITY PROGRAMS**



**SUPERIOR SOFTWARE**

Dept. BMU3,  
69 Leeds Road, Bramhope, Leeds.  
Tel. 0532-842714

**DISC SOFTWARE AVAILABLE NOW**

All our programs are ready for despatch on 5¼" discs at £11.95 each.

**WE GUARANTEE THAT:**

- (1) All our software runs correctly on all current operating systems and BASIC ROMs.
- (2) All our software is available before we advertise.
- (3) All our software is despatched within 48 hours by first class post.
- (4) In the unlikely event that any of our software fails to load, return your cassette or disc to us and we will immediately

# CONTENTS

## NEWS

9

Keep in touch with the latest happenings in the bustling world of the BBC Micro.

## ANIMATION

16

Put more action into your programs with the first part of our new series on animation.

## SCHOOL

22

The classroom where the children use a BBC Micro as naturally as they would a crayon.

## TURTLES

26

We review two of the new breed of robots that can be harnessed to the BBC Micro.

## TAPE TO DISC

30

Uploading your programs from tape to disc is simplicity itself with these techniques.

## SOFTWARE

35

Our reviewers give frank appraisals of the latest in both games and business software.

## STRUCTURE

39

Keep control of your programs by eradicating GOTOs. We show you how simple it can be.

## COMPETITION

41

Write a program to animate a high diver and you could win yourself a graphics digitiser.

## INSIDE KING KONG

42

We revisit one of our most popular games for a case study in structured programming.

## TAPE OFFER

51

Save yourself the chore of keying in programs from this issue with this month's cassette.

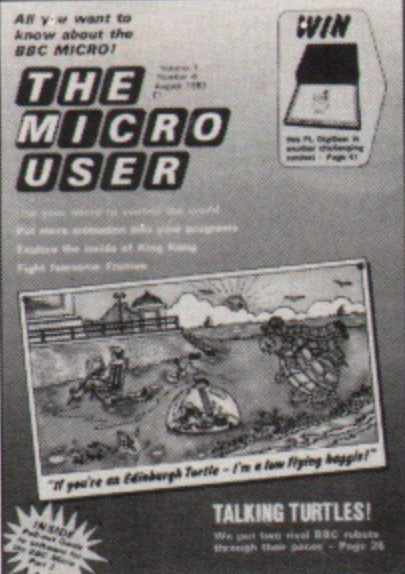

Vol. 1 No. 6 August

Managing Editor  
**Derek Meakin**

Features Editor  
**Mike Bibby**

Technical Editor  
**Mike Cook**

Art Editor  
**Peter Glover**

Advertisement Manager  
**John Riding**

Advertising Sales  
**Mike Hayes**

Marketing Manager  
**Linda Dobson**

Tel: 061-456 8383 (Editorial)  
061-456 8500 (Advertising)  
Telex: 667664 SHARET G

Published by:  
Database Publications Ltd,  
Europa House, 68 Chester Road,  
Hazel Grove, Stockport SK7 5NY.

Subscription rates for  
12 issues, post free:  
£12 - UK  
£13 - Eire (IR £16)  
£18 - Europe  
£15 - USA (surface)  
£25 - USA (airmail)  
£15 - Rest of world  
(surface)  
£30 - Rest of world  
(airmail)

The Micro User welcomes program listings and articles for publication. Material should be typed or computer-printed, and preferably double-spaced. Program listings should be accompanied by cassette tape or disc. Please enclose a stamped, self-addressed envelope, otherwise the return of material cannot be guaranteed. Contributions accepted for publication will be on an all-rights basis.

© 1983 Database Publications Ltd. No material may be reproduced in whole or in part without written permission. While every care is taken, the publishers cannot be held legally responsible for any errors in articles or listings.

The Micro User is an independent publication and neither the BBC nor Acorn Computers Ltd are responsible for any of the articles in this issue or for any of the opinions expressed.

Distribution to the news trade in the UK and Ireland is by Wells Gardner, Darton and Co Ltd., Faygate, Horsham, West Sussex RH12 4SU (tel: Faygate 444). Enquiries regarding overseas distribution should be made direct to the publishers.

## INSIDE this issue

Voucher  
worth



*off the price of  
admission to our  
second great show  
— coming soon to  
the Midlands!*



**Sherwood Rooms  
Nottingham**

**Friday to Sunday  
September 16 to 18**

### 54 FRUITIES

How long can you survive the terrors that await you in the garden of unearthly frights?

### 55 DIRECTORY

The third part of our pull-out guide to more than 400 BBC Micro software programs.

### 63 BACK ISSUES

Find out about the features you missed in the last five issues of The Micro User.

### 66 LOGICAL OPERATORS

A simple guide to the not so simple use of AND, OR and EOR in conditional statements.

### 70 MODE 7 COLOUR

We present useful machine code routines to bring superb vivid colour to your screens.

### 72 SUBSCRIBE NOW

A year's subscription to The Micro User will bring you a FREE copy-holder and crib sheet.

### 79 UPGRADE

Control the world with your BBC Micro. This month we link up with a dual cassette system.

### 88 TUTORIAL

We learn more about loops and the use of conditions in part six of our beginners' course.

### 105 MICROMAIL

The pages you write yourself — just a small selection from the letters that are flooding in.

### 108 MISSIVE

Our intrepid hero Bob is caught doing despicable things with his GOTO.

# Do you have a BBC MICRO? FED UP WITH LOADING & SAVING FROM CASSETTES?

## VIGLEN have the answer!

New Slimline Disc Drives – "TEACS" & "CANNONS" at realistic prices – cut the loading and saving time from minutes to SECONDS. 5¼"

DISC DRIVES up to 500K from **£190.**

**Special Note:** This is a Double Sided Drive.

\* All our Drives come ready cased to match BBC Micro colour. Complete with all necessary leads ready to plug in and use with BBC Model B with D.F.S.

Disc Formatter and User Guide **£15.00**

Come and see us at the Acorn User Exhibition – Stand No. 11, Cunard International Hotel, Hammersmith.

**25th - 28th August, 1983**

where you can try for yourself our Disc Drives and see our **Exclusive Console.**

We will be pleased to quote for your exact requirements.

All prices plus VAT.

## VIGLEN Computer Supplies,

Unit 7, Trumpers Way, London W7 2QA.

Telephone: 01-843 9903

Please send me:-

- |   |  |      |                       |   |
|---|--|------|-----------------------|---|
| A | <input type="checkbox"/> 100K Single Drive .....           | £155 | 400K Dual Drive ..... | £395  |
|   | <input type="checkbox"/> 200K Single Drive .....           | £190 | 800K Dual Drive ..... | £435  |
| B | <input type="checkbox"/> 400K 40/80 Track Switchable ..... | £210 | D                     | <input type="checkbox"/> BBC Disc Interface                               |
|   |  |      |                       | (incl. 1.2 ROM - fitting 48 hours) .....                                  |
| C | <input type="checkbox"/> 200K Dual Drive .....             | £325 | E                     | <input type="checkbox"/> Disc Formatter - comprehensive users guide ..... |
|   |  |      |                       | £15.00  |

All plus 15% VAT. P+P incl.

I enclose cheque for £ ..... or debit my Access/Barclaycard No. ....

Name .....

Address .....

.....  
Educational establishment orders welcomed.

# If you're serious about your BBC Micro... get some serious Software!



Microcomputers weren't created just to play arcade games or to be left unused once you've learnt the basics of computing. Micros are amazing machines and have many serious uses, but they are only as efficient as the software you run on them.

Psion are one of Europe's largest producers of microcomputer software with sales now exceeding one million packages. Our policy is to create quality software that takes full advantage of the processing power of your microcomputer and uses its capacity to the full.

## The Versatile Spreadsheet Program

Vu-Calc is a powerful program that constructs a spreadsheet for generating and calculating large tables of interdependent text, data and formulae.

A 'window' for viewing the spreadsheet can be scrolled in any direction so that the effects of new figures and formulae on all the other data can be observed.

Vu-Calc is supplied with a clear and detailed 16-page user manual, and its hundreds of applications include:-

- Cashflow Projections • Home Finance Management • Engineering and Statistical Tables • Investment Forecasting • Business Planning • Profit and Loss Statements • Break Even Analysis, and other complex calculation models

£14.95

## The Complete Filing System

Vu-File is a powerful data base management system that turns your microcomputer into a sophisticated general purpose filing system for manipulating information of all kinds.

Vu-File can be used to create dedicated data bases to suit your most varied needs. Features such as order, sequence, search, list and copy make Vu-File the most essential data handling software package available for microcomputer owners. Vu-File is supplied with a clear and detailed 16-page user manual, and its infinite applications include:-

- Catalogues of stamps, coins, books, records etc.
- Names and Addresses • Mailing Lists
- Customer Accounts • Estate Agents Lists
- Medical Records • Club Memberships
- Records and Lists of all kinds.

£14.95

We have now rewritten two of our most popular programs for use on the BBC Microcomputers (Model B or Model A with 32K RAM). *Vu-Calc* and *Vu-File* are powerful software packages that make practical and serious use of your microcomputer.

Supplied on cassette, they are designed for use with cassette or disk systems, and each program comes with a detailed user manual. *Vu-Calc* and *Vu-File* constitute essential software that no serious microcomputer user should be without.

## To the Retailer

Contact Psion to find out details of substantial discounts for trade orders of our best selling computer software.

Order Vu-Calc and/or Vu-File by using your Access or Barclaycard or send cheque/postal order for £14.95 per package to:-  
BBC Software Psion Ltd.,  
2 Huntsworth Mews, Gloucester Place,  
London NW1 6DD.

Enquiries can also be made at W.H. Smith or your local retailer.

Please make cheques and postal orders payable to Psion Ltd., and allow 14 days for delivery.

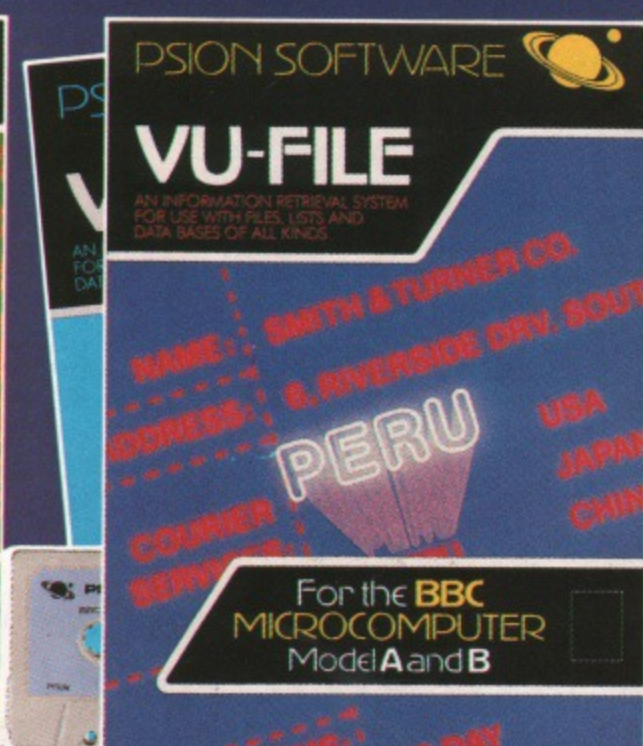
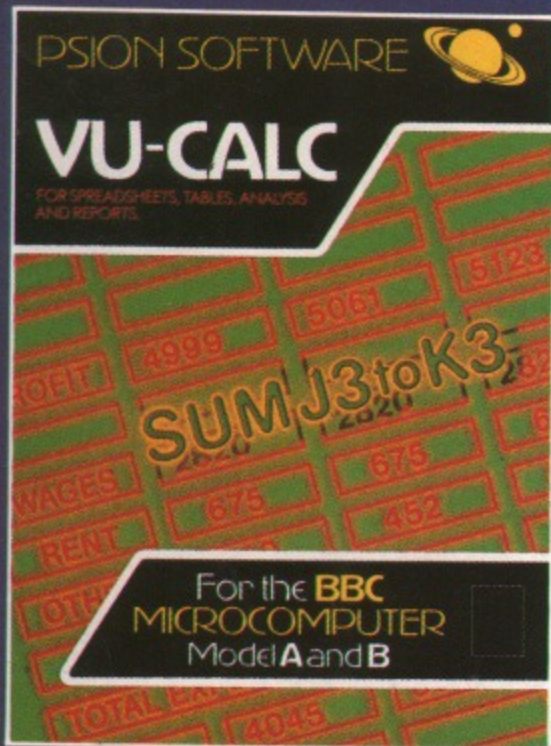

TO: BBC Software,  
Psion Ltd., 2 Huntsworth Mews,  
Gloucester Place, London NW1 6DD.

Please send me the following Software packages at £14.95 per package.

Vu-Calc (£14.95 inc. p&p and VAT)

Vu-File (£14.95 inc. p&p and VAT)

\*I enclose a cheque/postal order for £\_\_\_\_\_ made payable to Psion Ltd.

\*Please charge my Access/Barclaycard Account Number \_\_\_\_\_

Signature \_\_\_\_\_

NAME \_\_\_\_\_

ADDRESS \_\_\_\_\_

\*Delete as appropriate

# Join the jet set.

The Acorn Spark-Jet printer employs the very latest dry-ink printing technology, resulting in fast, clean and virtually noiseless printing.

This is all due to its advanced serial matrix printhead. Electronic impulses fire minute particles of the carbon rod at high speed through a 7x7 dot matrix, producing extremely high-quality lettering and graphics time after time.

And, as there are no moving parts within the head itself, the action is as quiet as a whisper.

In addition, the Acorn Spark-Jet printer is also capable of handling high resolution graphics and plotting.

It works with any 8 bit micro-computer, via the centronics parallel interface, and is specially recommended for use with the BBC Micro (also designed and built by Acorn Computers Ltd.) to form a thoroughly professional word, copy and graphics processing system.

All printing is logic-seeing and bi-directional and can be executed in normal, double height, double width and underlined characters.

And yet, with all these advanced features, the Spark-Jet costs only £365.



THE ACORN SPARK-JET PRINTER

Not only that, but you also receive a free program on cassette that enables you to 'dump' graphics from either monitor or TV.

If you're interested in joining the jet set, simply call in at one of the dealers listed below. He'll tell you everything you need to know.



MICRO MANAGEMENT  
32 Princes Street, Ipswich, Suffolk IP1 1QG.  
0473 59181.  
MICROSTYLE  
47 Cheap Street, Newbury, Berkshire. 0635 41929.  
COMPUTERS FOR ALL  
72 North Street, Romford, Essex. 0708 60725.  
JESSOP MICROELECTRONICS LIMITED  
Unit 5, 7 Long Street, London E2 8HN.  
01-739 3232/729 1851.  
WELBECK VIDEO  
26 Tottenham Court Road, London W1. 01-580 1328.

TWILLSTAR COMPUTERS LIMITED  
17 Regina Road, Southall, Middlesex UB2 5PL.  
01-574 5271.  
GROUP 70  
208 Maybank Road, South Woodford, London E18.  
01-505 7724.  
LEASALINK VIEWDATA LIMITED  
Scientific House, Bridge Street, Sandiacre,  
Nottingham NG10 5BA. 0602 399484/396976.  
CARDIFF MICROCOMPUTERS  
46 Charles Street, Cardiff, Glamorgan.  
0222 373072.

LEAMINGTON HOBBY CENTRE  
121 Regent Street, Leamington Spa, Warwickshire.  
0926 29211.  
RDS ELECTRICAL  
157/161 Kingston Road, Portsmouth, Hampshire.  
0705 812478.  
TWICKENHAM COMPUTER CENTRE  
72 Heath Road, Twickenham, Middlesex.  
01-891 1612.  
KELLY'S COMPUTER MARKET  
227 Dartmouth Road, Sydenham, London SE26 4QY.  
01-699 6202/4399.





The crowds gather . . . round the big Acorn stand

## Acorn — offering Econet, promises and policies

LARGEST stand at the BBC Micro User Show was taken, not surprisingly, by Acorn. However, they weren't there to sell, but to disseminate information.

Said regional manager Joe Black: "We're here to demonstrate our software, the second processors and to show the Econet system in full cry.

"We also need to be at the show to give the public policy decisions and statements that our dealers might not be in a position to give — for example on delivery dates.

"We are now fairly confident that we are giving people the right answers. Most enquirers leave the stand satisfied.

### Delighted

"In fact, a number of people have come onto the stand simply to say they are absolutely delighted with the BBC Micro — and that makes us absolutely delighted as well."

Joe confirmed that the 6502 and Z80 second processors will definitely be available in September.

"They are being produced in quantities at this moment," he said.

# Micro User Show draws 12,500 fans

BBC Micro enthusiasts from all over Britain flooded to the first BBC Micro User Show held recently in Manchester. Attendance was high throughout the three day event, and when the show finally closed more than 12,500 BBC Micro fans had passed through the doors.

With more than 50 companies represented, visitors to the show could find every conceivable product for the BBC Micro — many of which were on display to the public for the first time.

Among the new launches were Cumana's Z80 based second processor, and their new range of slimline disc drives.

Not to be outdone, Watford Electronics unveiled four products that

created much interest.

These were a 13 ROM socket board, a 16k disc filing system, a graphics plotter and an EPROM programmer/emulator.

New software included a range of games from Kay Dee Software, a data graphics package from Gemini and a ROM based spreadsheet program from Computer Concepts.

Pace's new DFS for the BBC Micro attracted considerable attention.

### Queries

Visitors were also able to pick up much useful information about the BBC Micro.

The Acorn stand handled many queries from users as did *The*

*Micro User's* own technical information stand.

Many hundreds of people took the opportunity to discuss their programming problems with the experts.

In addition, the show featured a "walk in forum", in which well-known names from *The Micro User* team of writers gave talks on every aspect of BBC Micro lore.

Subjects ranged from using it in the infants' classroom to interfacing it with mainframe computers.

Each day visitors were invited to quiz speakers in several lively Any Questions sessions.

### Kitemark accolade

THE BBC Micro has been selected by the Design Council of Great Britain for the Design Centre.

It is only the second computer allowed to bear the famous Kitemark (the Sinclair ZX81 was chosen in 1981).

## BOOTS DROP MICRO BOMBSHELL

— See  
Page 14

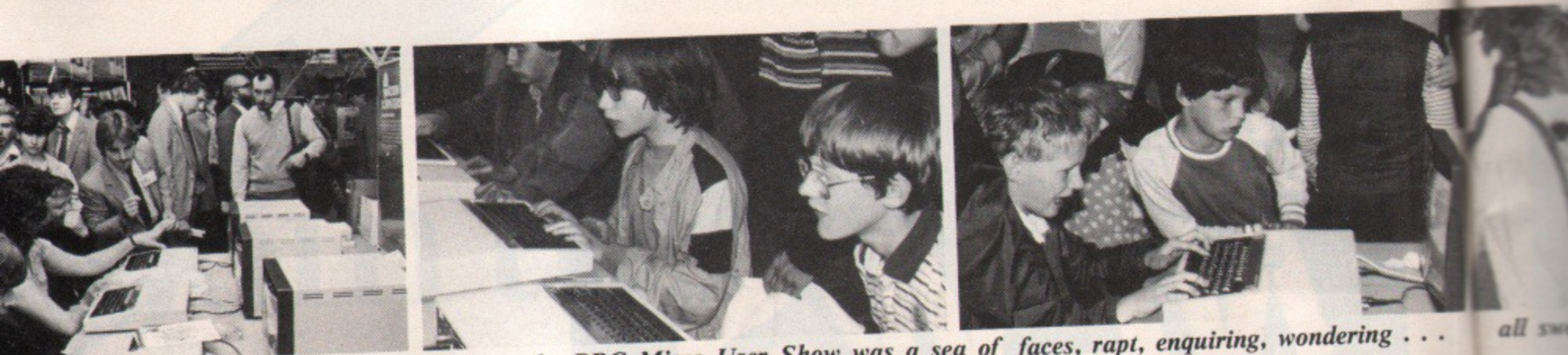

They came in their thousands . . . the BBC Micro User Show was a sea of faces, rapt, enquiring, wondering . . .

## Starsoft

was

watching

you . . .

VISITORS to the Starsoft stand at the BBC Micro User Show made a significant contribution to the company's software development — although they didn't realise it.

"As a result we got a lot more than just sales and publicity," said one of the company's programmers.

A sophisticated database program was in operation while the company's educational programs were being demonstrated.

### Improve

It analysed the input or response to the programs from the stand visitors. The results will be used to help modify and improve programs.

"I'll be able to find out whether the programs run too fast, or whether the interactive questions are easily understood or relevant," he said.

### Understand

"For example one program asked the user to respond 'Red, Green, Yellow or Hit Any Key Twice' and no one seemed to understand the last option."

Starsoft only exhibited on the last two days of the show. They said the response had been fantastic — far better than expected.

"I had thought it would be boring — but now I am converted and if Micro User holds another show, we will be there," he said.

## ROYALTIES START AT 17

SCHOOLBOY Nicholas Tingle, 17, received a cheque for £2,000 at the BBC Micro User Show. The money was an advance royalty payment for an arcade game written by Nicholas for the BBC Micro.

The managing director of Gemini Marketing,

Dale Hubbard, pictured left, handing the cheque to Nicholas, used the occasion to finalise contracts for the royalty arrangement.

Nicholas is studying for his chemistry, mathematics and physics A levels at Bishop Vesey School, Sutton Coldfield.

He developed his programming skills at home and bought his first computer, a Sinclair ZX81, about four years ago, upgrading to a BBC Micro a year ago.

It took him two months to complete *Missile Control*, which is written entirely in



machine code. It will be one of six games titles launched by a Gemini subsidiary, *Supernova Software*, next month.



The Micro User's technical advice stand did a roaring trade answering questions from visitors. Manning the stand were many of the writers from the pages of the magazine.

## Funny things happened at the forum

HIGHSPOT of the BBC Micro User Show was for many visitors the walk-in forum.

Friday's sessions were devoted to the use of the BBC Micro in education, with great emphasis on practice rather than theory.

Star of the show was diminutive Wyn Moore, headmistress of a

Bradford school. Her description of how the BBC Micro came into the life of her school gave her audience a great deal of useful advice in a thoroughly entertaining manner.

Equally practical was Don Fuller's talk on designing educational software.

The weekend's talks

catered for the general BBC Micro user. Mike Cook's lecture on interfacing demonstrated that he could talk as humorously and informatively as he can write.

He also produced the definitive single board computer. He built it on a piece of wood!

Fellow *Micro User* writer Paul Leman

created tremendous interest with a series of demonstrations of animated graphics.

Hardest worked writer of the weekend was Paul Beverley, who entertained the audience with no less than seven lectures on various aspects of machine code on the BBC Micro.

On both the Saturday and Sunday the speakers joined forces to present *Any Questions?* where they faced a barrage of queries from BBC Micro enthusiasts.

The interchanges were lively and often extremely humorous, with the audience playing as great a part as the panel.

Said one expert: "I think we learned as much from the audience as they did from us."

## CHIPS WENT APACE..

A DEALER order for more than 1,000 DFS chips a month and others for 100 a month were taken by Pace Systems of Sheffield.

The company sold out of virtually all its show stock, including more than 200 disc drive units, some of them twin drives costing more than £700.

"It was a very competitive show and the quality of people visiting our stand was high," said David Hood of Pace. "We had seven staff on the stand and for most of the three days had people queuing up to speak to them."

"It was our first show, and we had no idea we would do so well."



all swept up in the exciting world of the BBC Micro

# INTO THE REAL WORLD OF INSTRUMENTATION

"BBC Basic has at last entered the real world of control and instrumentation", said Dave Hunt, technical director of Cube Computers, commenting on the Micro User Show launch of the Eurocube.

## GAMES RANGE LAUNCHED

The product is unique among single board computers in that it can run BBC Basic.

Said Hunt: "You can develop programs either in assembler or BBC Basic on the BBC Micro. Then, using our side-ways ROM utility called Terminal, you can load it into Eurocube which then acts as a stand alone computer.

### Dedicated

"We buy our Basic ROM from Acorn. It gives the user all the advantages of BBC Basic without having to tie up the more costly BBC Micro as a dedicated computer."

Also released by Control Universal was Beeb-Ex, an interface card which is attached to the BBC Micro 1MHz bus

port by a 34-way ribbon connector.

Beeb-Ex runs the complete Cube range of 30 Eurocards produced by Control Universal, as well as the Acorn Eurocards.

A spokesman said it is difficult to choose a "typical" application for Beeb-Ex, but most likely passengers on the bus would be 64/80 channel digital I/O, 8 or 12-bit analog interfaces and extra memory.

256 bytes of memory are addressed directly, but up to 1mbyte may be addressed in page mode.

This capability offers the possibility of a "silicon disc" (or "virtual disc") of battery-backed CMOS RAM, or up to 1mbyte of paged DRAM.

A second permutation of extension products could include the battery-backed real time calendar clock, additional independent video outputs, heavy duty industrial switch outputs and additional independent serial I/O.

Beeb-Ex is available in

two versions. A stand-alone unit which holds up to four other Eurocard devices by their edge connectors, costs £49.

The second type is designed for more ambitious applications, slotting into a standard rack-mounted system of up to 14 backplane connectors. It costs £41 for the interface, with racks from £72.

Data transfer along the 1mhz bus is achieved by using "Fred" and "Jim", the two special pages of the BBC's MOS (Machine Operating System) which control memory mapped I/O.

### Forth disc

ACORNSOFT continue to maintain the policy of releasing not only arcade games, but more serious software.

Just released on disc is Forth for the BBC Micro. The package consists of a Forth dictionary and compiler, an editor, assembler and high resolution graphics demonstration.

**Now we're taking our big show out to the users!**

*THE first-ever BBC Micro Users Show was such an outstanding success that many people have asked if it could visit other parts of the country.*

*As a result the organisers, Database Publications, have agreed to take the Show on a round-Britain tour, visiting all the major regional centres.*

*The first stopping point will be the Midlands on Friday, Saturday and Sunday, September 16 to 18. The venue will be the plush Sherwood Rooms in Nottingham.*

*Then, in December, the Show goes to London. It will take over the Westminster Exhibition Centre during the weekend of December 9 to 11.*

*Said a Show spokesman: "We want users everywhere to find out how they can really make the most of the BBC Micro - and try out for themselves all the exciting accessories that are becoming available.*

*"By taking the Show on tour we shall be giving everyone an opportunity to keep bang up to date with all the tremendous developments now taking place."*

*● There will be a special discount off the admission price for party bookings.*

*For details write: Group Bookings, Micro User Show, Europa House, 68 Chester Road, Hazel Grove, Stockport SK7 5NY.*

*Or phone Linda Dobson on 061-456 8353.*

## GETTING TO KNOW YOU

A FIRM specialising in educational programs, Walcam, weren't expecting on-the-spot sales and brought no stock to sell.

But a spokesman said: "We've been able to show what our programs can do and teachers can now go away and try to get a budget to buy them.

"However, we think it has been worthwhile. We have certainly made some good contacts with

people in the right places".

★ ★ ★

MANY firms used the show purely to get themselves known. One was Rikadenki Mitsui Electronics, who had three new plotters on display.

"They aren't actually in stock yet and we couldn't have supplied them if there had been orders", said a spokes-

man. "We were looking for - and think we will achieve - longer term benefits".

★ ★ ★

*THE show was fantastic - "especially in terms of getting our company known" - said Brian Howarth of Digital Fantasia.*

*"One of our problems has been that competitors, such as Acornsoft, have much*

*greater marketing resources than us. This show has helped us redress the balance".*

★ ★ ★

Sunday was a day of clear profit for Squirrel Software, whose takings on the first two days of the exhibition more than covered its costs.

"We have had a fantastic response said managing director Alan Turner.

# Acorn's distribution goes regional

**Palette produces colours galore**

A MAJOR reorganisation is underway at Acorn which could move the company from its current production-led orientation to place more emphasis on the sales side.

It includes a major restructuring of the company's UK distribution network with the appointment of a series of regional distributors, plus new management appointments that reflect the success of the BBC Micro and its expansion into world markets.

The end result could be a much more efficient back-up and service for BBC Micro users.

Until now there have been two distributor networks, one run by Acorn itself and the other by Leasalink Viewdata.

Under the new plan - still to be confirmed by Acorn - the distributorships will be put on a more localised basis.

Three distributors have already been appointed,

subject to final contract - Micro Management at Ipswich, Eltec at Bradford, and HCCS, Gateshead.

They will take over many of the functions currently handled by Acorn and eventually will be responsible for training new dealers.

## Buffer

Once adequate facilities have been established they will also handle "a certain element" of repair work and in general act as a buffer between Acorn and its dealers.

Joe Black, Acorn's regional sales manager, told *Micro User*: "The whole idea of having a centrally located distributor in a region is that hopefully the buck will stop with him and the

need for people to deal directly with us should fall away.

"The distributor will shoulder much of the burden of providing customer support".

Black admitted that at present Acorn receives thousands of requests for help and guidance each month, and doesn't deal with them as it should.

Now he expects the situation to improve.

LVL doesn't appear too perturbed. It already services its dealers direct without having to trouble Acorn, and has developed a strong national distribution chain.

It is likely that this will be left unchanged except where there is a conflict between LVL's network and the new regional concept.

A conference between LVL and top Acorn management and directors is planned to iron out the details.

Roy Griffin, joint managing director of LVL, said the regionalisation plans wouldn't affect his company's terms of reference or operation.

"We work closely with Acorn and have done everything we have been asked to do as well as a lot more that Acorn

hasn't got around to doing," he said.

"The new plans should lead to a much more orderly marketplace - and hopefully will mean that unpleasant problems that trouble other manufacturers, such as price cutting, can be avoided".

## Extra prize in disc drive contest

IN the May issue of *The Micro User* the closing date for the competition was incorrectly printed as June 30, instead of May 30. The prize awarded last month was based on entries received up to May 30.

However, all the entries submitted for the contest have now been judged and Cumana have very generously donated an additional 40-track 100k drive, together with its connecting cable and a book, *Using Floppy Disks with the BBC Microcomputer*.

It has been awarded to Ian Tresman of Elstree, Herts.

ONE of the most exciting launches at the Micro User Show was the Chameleon Colour Palette.

Produced by Wilmslow Micro Centre, it allows the user to produce spectacular new colours on the BBC Micro.

Instead of being restricted to garish primary and secondary colours, it offers alternative palettes of eight colours from a range of 4,096 shades, allowing for far greater realism in graphic displays.

The Chameleon's software not only allows the user to mix the exact shade required, but also allows him to pick two extremes of a colour range which the Chameleon then fills in.

Having chosen a colour, its brightness, saturation and hue can then be varied until the user's exact requirements are met.

Said general manager of Wilmslow Micro Centre Roger Ambrose: "We anticipated a fair amount of interest in the Chameleon. As it was we were swamped."

The Chameleon is at present restricted to colour monitors. A UHF version which can be used on domestic TVs will be available shortly.

## Join the MUGs!

THE Micro User team have been overwhelmed by the response to the formation of Micro User Groups - MUGs for short - dedicated solely to the BBC Micro.

People from nine to ninety have been writing in to find out more about their local MUGs, and many have offered to lend a helping hand to get them started.

In addition many well established local groups are joining up with MUGs.

If you aren't already a member of a user group you should be - you're missing out on a lot of fun and info.

If you do belong to a group, why not get it to affiliate with MUGs and take advantage of the many benefits the network can bring you?

So, if you're interested in getting in touch with your local Micro User Group, or could help in setting one up, why not fill in the coupon below and let us know?

### SEND TODAY!

- I would like to become a member of my local Micro User Group.
- I would like to help in setting up a local Micro User Group.

Name .....

Address .....

Phone No .....

POST TO: MUG, Micro User, Europa House, 68 Chester Road, Hazel Grove, Stockport SK7 5NY.

## ECONET ON THREE LEVELS

THREE levels of Econet are now available.

Level one is a slimmed down version of Econet, using a disc-backed model B as file server and simplified software.

Level two, available at the end of September,

uses a model B with 6502 second processor. Its software provides a full implementation of Econet.

Level one users will be able to upgrade to level two simply by purchasing the second processor

together with the required software.

Level three is the original version of Econet using Acorn's System 3.4 or 5. This will be phased out as the other two versions begin to come on stream.

## SINCLAIR'S SALES SWITCH

SINCLAIR Research, maker of the ZX Spectrum, seems to have conceded the UK educational market to the BBC Micro and is now trying to boost sales of its educational software by

releasing it to the general public.

Special software was commissioned by the Department of Education and Science for use with the three micros recommended under the

government's "Micros in Primaries" scheme - the BBC Model B, the Research Machines 480Z and the Spectrum.

More than 80 per cent of schools have opted for the BBC Micro.



Mrs Thatcher ... no stranger to the BBC Micro herself. Staff from Salford University accompanying her are (left to right) Professor John Ashworth, vice chancellor of Salford University, Dr Brian James, Professor Graham Ashworth and Dr Graham Keeler

## It's the micro road show

A BUS-load of BBC Micros has been doing the rounds at 10 Downing Street and Buckingham Palace.

The double decker bus, flagship of Salford University's micro roadshow program (see the May *Micro User*), proved so interesting that Mrs Thatcher, who had invited it to the capital, extended her scheduled 15 minute visit to 50 minutes.

After that the bus went to the Palace where the Duke of Edinburgh, who is chancellor of Salford University, "toured" both decks.

On show was a simulation of a typical schools visit with 12 BBC Micros on the bottom deck running various physics teaching programs, and on the top deck six BBC Micros linked together under Acorn's Econet system.

The Salford double decker has also attracted attention from the Mediterranean. The *Micro User* offices received a telex from Mr Alex Axarlis, sole distributor of the BBC Micro in Greece, who wants the roadshow to visit Athens.

Roger Moss, one of the organisers, is enthusiastic about the idea.

# PM's biography goes on Beeb

WRITING an official biography of the Prime Minister may have been possible without actually meeting and speaking to Mrs Thatcher but it wasn't possible without the use of a BBC Micro.

The book, "Margaret Thatcher - Woman, Mother, Politician", was serialised recently in the *Daily Express* and is to be published on October 13, Mrs Thatcher's birthday.

It was written by freelance journalist Penny Junor who combined her research and writing with a full-time job as an investigative reporter with Channel Four Television's "For What It's Worth" programme.

"I started the book and the television contract last September. Both jobs were really full-time and I had to complete the book by last May. Finding the time to write was a problem," said Penny.

She did most of the research for the biography and then found a six-week gap during the



Penny Junor .. "I'm sold on using the BBC Micro"

TV series to do the writing.

"I was persuaded that I'd be able to work much faster if I used a word processor, and a friend suggested that a BBC Micro would do the job."

Penny was one of the lucky people who actually managed to get a disc drive from Acorn.

Her system consists of a BBC Micro, Wordwise, the Acorn disc drive and a Brother printer.

"No disc drives were available at the time but Acorn opened up their

factory to get one out when they heard whose biography I was writing," she said.

It took Penny just a morning to learn how to use the machine but she admits she still hasn't had time to read the User Guide.

Had she done so, she says she probably might have avoided the one major catastrophe she's had with the machine to date.

### Transfer

"At about 1am one morning I lost 4,000 words. I hadn't formatted a spare disc, and when I tried to transfer my work to disc I was told my data disc was full.

"Stupidly, because I hadn't had time to read the manual, I tried to format a disc and lost the 4,000 words in the process."

There was another minor irritation with Wordwise. It required the help of a programmer friend to enable her to

incorporate exclamation marks and paragraphs in her text.

Then when the work was finally completed Penny had problems trying to get her printer to work with the BBC Micro.

Despite that, she told *Micro User*: "Now I am sold on it - although the memory capacity of 4,000 words is restricting when writing an 80,000-word book.

"My children, of course, spend most of their day on it, both with games and programming."

Much of the material for the book is based on conversations with people who knew or know Mrs Thatcher.

Penny says that a simple interview with Mrs Thatcher herself would have been too short and perhaps not as revealing as talking to others.

Penny has an electric typewriter but seldom uses it. She employs the micro for writing scripts and "anything else".

## Way out

AN exciting new service is being developed for adventure program addicts. If they're lost in a maze or trapped in a dungeon and they can't get out a software company in Harpenden is offering to help them.

Adventure-Zone Software, a mail-order firm which specialises in adventure games, plans to act as a forum for adventurers where they can swap ideas, hints and tips.

# Micro has a word for it

OT on the heels of the speech synthesiser chip comes a device which allows the BBC Micro to reproduce human speech on disc.

The Voxbox Voice Digitiser converts the sound of the human voice to a series of "O"s and "I"s which can then be stored as disc files.

Users can build up voice files of words and phrases and then access them from their own programs.

Multiplex Computer Services who make the Digitiser claim that the reconstituted speech quality is good with no loss of stress or intonation. They see it as particularly useful for such tasks as language learning, pronunciation and spelling.

# BOOTS TO SELL

## BBC MICRO

BBC dealers reacted as if a bombshell had struck them when Boots the chemists revealed they planned to start selling BBC Micros "within the next couple of months."

The chain already sells a range of five cheaper home computers in 180 of its branches.

They say the BBC Micro will only be sold at 30 of its main stores in major city centres.

But many worried dealers told *Micro User* they fear this could be the start of a price cutting war, with High Street stores putting smaller dealers out of business.

Some are concerned that the user will suffer with stores unable to offer the support and service provided by the independent dealers.

However Boots say

they will not sell cut-price BBC machines and stress that they will be sold by trained staff.

Says Anton Boyes, in charge of Boots micro retailing: "We aren't in the business to cut prices - it is our experience that it is the smaller dealer who cuts them."

"Acorn needs to expand the market and the only way it can do that is to bring in the multiples."

### Expand

"Our presence will guarantee a larger base of users."

"And as a result the market for peripherals and software will con-

tinue to expand", he said.

Boots hope to gain quite a chunk of that peripheral market.

They have been selling 24 software packages for the BBC Micro for some months.

Now they plan to start selling Acorn disc drives and cassette recorders.

Many dealers are caught between creating a good public image for Acorn and their own personal feelings.

Paul Vaughan, of Broadway Electronics, said: "The dealers have supported the BBC product from day one on extremely low margins."

"For them to see their slice of the market eroded by the multiple stores seems to me to be extremely disloyal on Acorn's side."

"For some time now most dealers have found that when they place an order for BBC Micros only a quarter is ever supplied."

"When we see more dealers, such as Boots with its 30 outlets coming on board we think that the small quantity of machines we are actually being supplied with will be eroded further."

"It isn't in the public's

best interest to have a product the quality of the BBC Micro sold in the High Street shops, no matter how professional they might be.

"I'm very worried that if Acorn doesn't keep its act together - based on the dealer providing good service - the Japanese will come in with the right product at the right price and provide serious competition."

A man with a foot in each camp is Michael Jardine, who runs both Leasalink Viewdata, Acorn's main distributor, and Oakleaf Computers, a BBC dealership.

### Stimulating

"By the end of 1984 most multiples will be selling micros, and doing it properly with properly trained staff," he said.

He thought their presence could help dealers by stimulating the market.

However it would also mean that to survive dealers would have to improve their standards and provide a better service.

Jardine said the casualties could be the very small companies who didn't have the capital to market themselves properly or the business experience to develop on a sound footing.

He calls them "the computer people without business sense and experience."

### Policy

Joe Black, Acorn's regional sales manager, said the company's pricing policy would not change.

Boots would become a dealer and their discount structure would be the same as the existing dealer network's.

He added: "What they sell the machines for is entirely up to them however."

## LEFT HANDED INPUT

A LEFT-handed graphics input device for use in computer aided learning and design has been developed by Academic Software.

It is a version of the Cad-get, the company's graphics entry tablet which incorporates a jointed arm potentiometer device with twin

pushbutton control.

Each tablet costs £70 and is said to be individually calibrated using computer based iterative bit mapping to ensure accuracy of performance.

Also available is the Cadstick, a joystick with alternative double thumb-wheel control for precise

vertical and horizontal lines which also uses twin pushbuttons to direct the move and plot options.

The menu options for both devices include erase, redraw, text, trace, full line/dotted line, rectangle, arc/circle, polygon, fill/draw, background and foreground colour selection.

## BARRY WOOD'S TAILPIECE

A RUMOUR circulating in the bar at the Micro User Show has it that Acorn are so fed up with people ripping off their software that they're going to release a new kind of game.

All you get for your money is a unmarked cassette in a plain brown wrapper.

The actual game itself is trivial.

The pleasure comes from figuring out how

to copy it.

\*\*\*

*TALKING about the show, did anyone else notice the exceptionally heavy traffic between the stands selling ROM based software and the stands selling EPROMs?*

*I was shocked.*

\*\*\*

WELL, no one managed to spot me at the show, but I was

there all right.

High point of the weekend for me was the free-for-all Any Questions? session.

It was delightful watching our beloved editor squirm as his experts blithely expounded on how to rip off protected software.

\*\*\*

*SO Uncle Clive is releasing the MEP soft-*

*ware to the general public, is he?*

*It couldn't be that since the Spectrum lost out so badly to the BBC Micro in the educational market he's trying to get in by the back door?*

*Or could it?*

*I can see it now - macintoshed men standing outside primary schools hissing: "Pssst! Want to buy some educational software?"*

# TCL

# Look at our ★ buys!

# Twillstar Computers Limited

## Out of this world product and prices.

**ACORN DEALER**

**BBC Service & Information Centre**



All prices include VAT

### BBC Microcomputer

Model A .....	£299
Model B .....	£399
Upgrade Kit .....	£51.75
Disc Interface Kit .....	£109.25
Teletext .....	£225.00
Dust Cover .....	£3.95
Speech Synthesizer .....	£44.00
1.2 Operating System .....	£11.50

Fitting Service available

### Disc Drives

All BBC compatible

We carry the complete range of standard, slimline and 3" disc drives for the BBC micro, including slimline switchable 40 to 80 track.

Just arrived at low, low prices.

200K cased Pertek drive .....	£200.00
- 40 track, 5¼", double sided	
400K cased Pertek drive .....	£390.00
- 40 track, 5¼", double sided	

Free Cable and paper with printers

### Dot Matrix Printers

CP-80 Type 1 **£305**  
(Friction and tractor feed)

★ STAR BUY

Epson MX 100FT III .....	£431.00
Epson FX 80FT .....	£431.00
Epson RX 80FT .....	£305.00
Seiksha GP 100 A .....	£207.00
Seiksha GP 250 X .....	£276.00

Full Graphics

### Daisy Wheel Printer/Typewriter

Silver Reed inc. RS 232  
interface plus 2K buffer - **£431.00**  
**NEW!** Juki 6100 Daisywheel - **£431.00**

★ STAR BUY

### Monitors

Microvitec 1431 - 14" colour  
inc. lead - **£287.00**

14" Hitachi TV/Monitor  
**£245.00**



★ STAR BUY  
★ STAR BUY

Zenith 12" green .....	£92.00
Official BBC Microvitek .....	£95.00
A 14" British colour monitor at a price you really can afford .....	£228.00

### Odds

Official Joysticks .....	£13.00
Compatible Joysticks-(Damping control)	£15.00
Stackpack - 10 cassettes C10 .....	£5.50
Micromanagement light pen .....	£23.00

### Cassettes

All BBC compatible	
Sanyo DR101 .....	£44.85
Elftone .....	£32.20
Koyo M8150 mini .....	£24.15
Official BBC cassette recorder .....	£29.95

12 month "no quibble" warranty on all products

★ STAR BUY

### Word Processing

BBC Model B, VIEW, Silver Reed  
daisywheel, disc drive, disc interface  
all leads and manuals .....

£1,199

### Books

Complete range of books including:

Advanced 6502 Interfacing .....	£11.00
Programming the 6502 .....	£9.95
6502 Software Design .....	£11.50
Programming and Interfacing the 6502 .....	£14.40
Practical Programming for BBC and Atom ..	£5.95
Easy Programming for BBC Micro .....	★ £5.95
35 Educational Programs for BBC Micro ..	★ £6.95
Further Programming for BBC Micro .....	£5.95
Programming for BBC Micro .....	£6.50
Learning to use the BBC Micro .....	£4.95
Basic Programming on the BBC Micro .....	£5.95
21 Games for the BBC Micro .....	£5.95
30 hour BASIC .....	£5.95
BBC Micro Revealed .....	£7.95
Games BBC Micro Play .....	£6.95

★ STAR BUY

### Software

Complete range from Bug-byte, Program Power, IJK, A&F, Acornsoft, including: Missile base, Castle of Riddles, Chess, Snooker, Starstrip Command, Countdown to Doom.

SERVICE CONTRACTS TO EDUCATION AUTHORITIES AT DISCOUNT. INSTITUTIONAL AND EDUCATIONAL ORDERS ACCEPTED.



Barclaycard and Access



We can't possibly list all we stock, so pick up the phone and ring 574 5271 and just ask - we'll be pleased to give you our best prices.

CARRIAGE ON COMPUTERS, PRINTERS ETC £8.00  
No delivery charge on large orders.

**Twillstar Computers Ltd., 17 Regina Road, Southall, Middx. Tel: 01-574 5271**  
**Open SIX DAYS A WEEK - 10am-8pm**

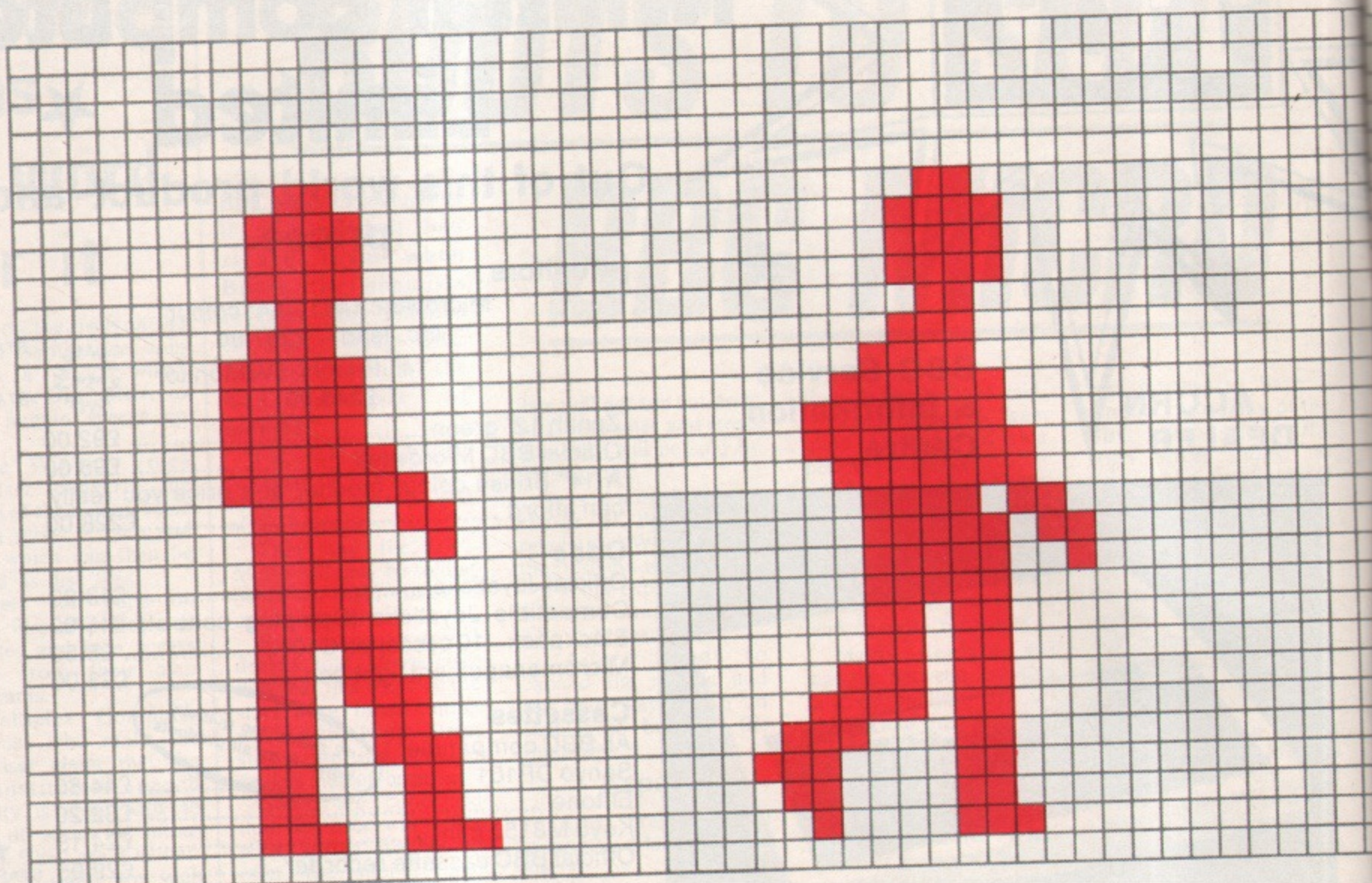

Figure 1

ANIMATION can greatly enhance a program. It can, for example, be used to clarify how sorting algorithms operate, explain how Basic statements are executed, or even used for fun.

Probably the easiest form of animation on the BBC Micro is character animation. This is where objects are moved around the screen by printing redefined characters or using the standard character set.

Printing a character or group of characters is faster than displaying the

equivalent form using PLOT commands. As I mentioned in my article in the April issue of *Micro User*, Mode 7 printing is faster still.

However, given this there are two ways that we can use PRINT to animate.

- Using the default text character option. Text characters overwrite what is already on the screen so that the background in the 8x8 bit cell removes any trace of a previous character.

This can give very smooth animation

effects, but is limited to the use of simple background and foreground colours.

Characters can be speedily placed anywhere in the text positions available for the current mode by the use of TAB(X%, Y%).

- Graphic printing with the cursors joined by VDU 5. Graphics characters are mapped onto the screen by the logical operation specified by GCOL. This gives access to the more exotic facilities such as foreground/mid-ground/background effects that will be discussed in a later article.

Characters can be placed anywhere on the graphics screen by the use of MOVE X%, Y%.

Both methods, however, require careful planning and a little graphic skill to produce an effective animated sequence.

On the left is a Basic program that shows the difference in the methods.

Notice that when using the text method the character to be printed is preceded by a space which is used to overwrite the previous character.

The graphic method is to draw and undraw characters either by using the logical operations available from within GCOL or drawing over the previous picture in the background colour. This method can result in slow jerky animation, but an improved method will be

```

0 REM Graphic method
5 MODE4
8 VDU23;8202;0;0;0;
10 GCOL3,3
15 VDU5
20 VDU23,224,255,129,129,153,153,12
9,129,255
25 A$=CHR$224
30 B$=CHR$32+CHR$224
35 WZ=5
40 oldXZ=0
45 MOVEoldXZ,512:PRINTA$
50 FOR newXZ=32 TO 1024 STEP 32
55 MOVEoldXZ,512:PRINTA$
60 MOVENewXZ,512:PRINTA$
65 oldXZ=newXZ
70 PROCwait(WZ)
75 NEXT
80 Q=INKEY(500)
85 REM Text method
90 VDU4
95 newXZ=0
100 PRINT TAB(newXZ,16)A$
105 FOR newXZ=0 TO 31
110 PRINT TAB(newXZ,16)B$
115 PROCwait(WZ)
120 NEXT
125 END
130 DEFPROCwait(TZ)
135 NZ=TIME
140 REPEAT UNTIL TIME-NZ>TZ
145 ENDPROC

```

Program 1



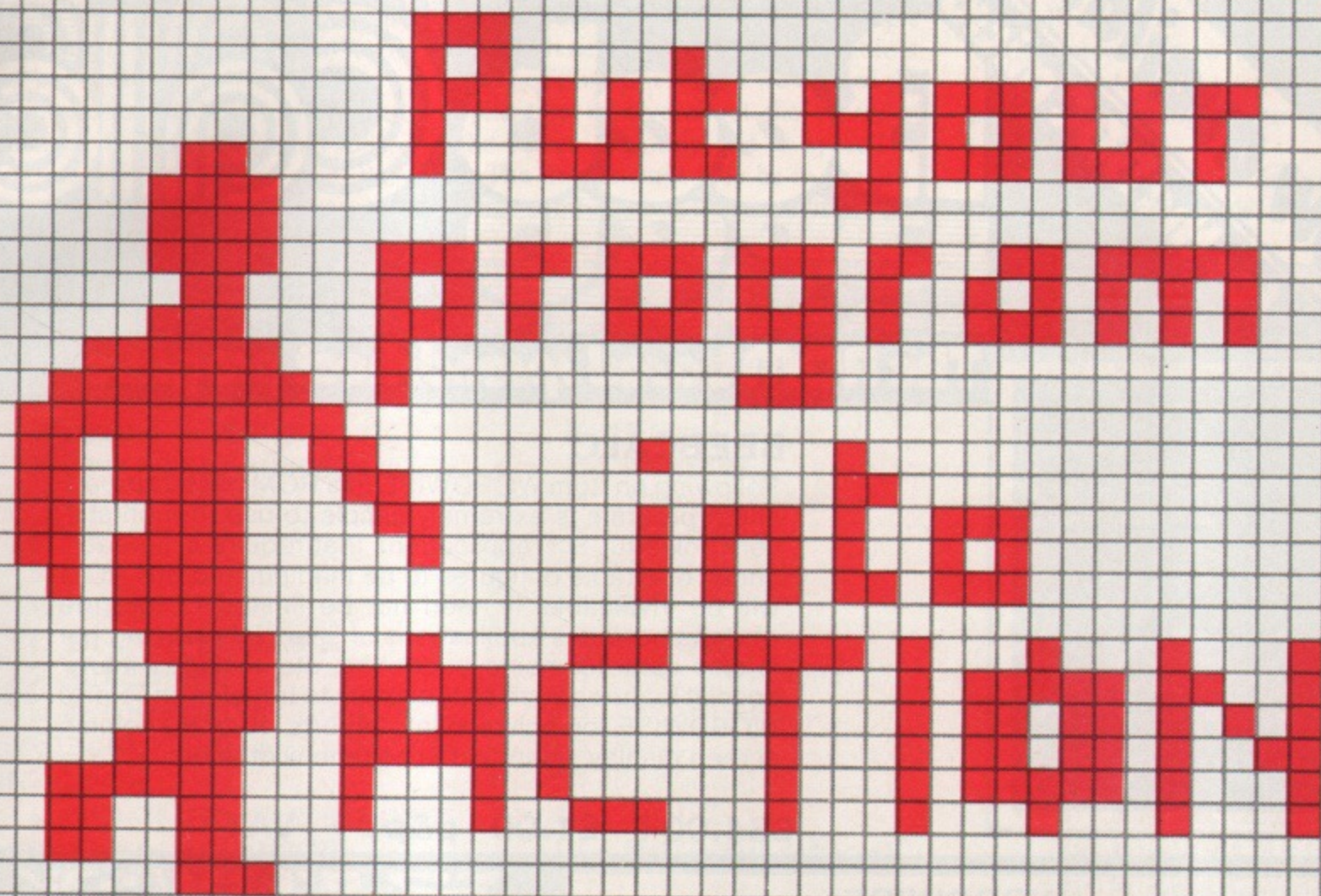

discussed later. Both techniques can be used to animate larger objects. However, as the objects get bigger, the text method becomes obviously more efficient.

To aid speed it is useful to define each figure in a sequence as a string made up of the required characters with appropriate backspace (CHR\$10), linefeed (CHR\$8) and space characters (CHR\$32). I shall call this a block graphic. In Mode 7, colour and other control characters may be included.

This method is used in Program II to animate a figure walking across the screen.

Each one of the three figures used to produce the sense of movement is made up of a series of redefined characters held in a string variable containing backspace and cursor down characters. The block shapes are shown in the illustration above.

The dots are positioned in the defining characters so that as subsequent blocks are drawn blank areas of the new block overwrite the dots of the previous block. This positioning is the only real skill involved.

One of the major problems of animation on a small micro is the speed of putting the image on the screen versus the refresh or framing rate of the TV or monitor used. A refresh occurs every

## By ALAN PLUME

1/50th of a second.

However, if the whole image cannot be displayed in this time, or if the drawing is initiated just before one occurs, a vertical scan line can be seen moving across the image.

This would typically happen when moving a large block of characters vertically.

Acorn have thought of this and (at least in OS 1.0 and above) allowed the user to wait for this event. For most programs this can be achieved with \*FX 19, but the vertical field event can also be enabled and acted upon from within machine code programs.

This waiting does, of course, slow things down a bit, but also increases the smoothness. A very useful facility indeed!

If you have OS 1.0 or above then replace line 120 by \*FX 19. (See Program II.)

Now suppose we would like to create further sequences of movement for this figure, say walking right to left and waving the arms around.

The three original figures used 17 characters out of the normal 32 re-

definable characters. Once again (in OS 1.0 and above) there is a \*FX call available to extend this range. It is \*FX 20, which is said to "explode" the character sets.

There is an error in the User Guide concerning this and a corrected version of the table on page 427 is shown in Table I on Page 20.

For my full program I'd like to have three figures showing movement either way, and say three figures for the arm movements. This means over 32 characters to redefine.

We will thus need \*FX 20,1 plus the appropriate repositioning of PAGE at OSHWM + &100. On a tape system this would mean PAGE=&F00 and on a disc system PAGE=&1A00.

Also notice that the characters stored at &C00 now start with Ascii code 128 (&80). The extra set will be stored at OSHWM + &100 and start from Ascii code 160 (&A0).

The additional DATA statements and formation of all the block graphics is given in Program III. Note that this is not a complete program.

It will be a useful exercise for you to see if you can add the right to left movement plus the arm waving to the original program.

The final example will show that for some more complicated displays

**..Now available..**  
for the BBC micro

# Beeb Calc

The ROM based spreadsheet program

1	A	B	C	D	E
2	MONTH	JAN	FEB	MAR	
3	RENT	6.67	3.14	22.45	
4	REPAIR	32	43	65	
5	PAPER	05	12	43	
6					
7	TOTAL	7.04	3.69	23.53	
8		1.06	55	3.51	
9	TOTAL	8.10	4.24	27.06	

## BEEBCALC

Following on from WORDWISE this ROM based spreadsheet program is extremely simple to use though still very powerful. For applications that require a 'spreadsheet' or a table of figures to be manipulated this ROM will be invaluable. It need not be limited to just the obvious business applications of financial planning but is also ideal for home budgeting, etc. Includes many special features such as the ability to transfer 'sheets' to WORDWISE for inclusion into reports. 40 or 80 column screen display, changeable column widths etc.

£34.00+ £1.00 p&p + VAT

## WORDWISE

The renowned word processing package. Still clearly the market leader with sales now over 10,000, this has become "the standard" word processor for the BBC Micro — and it's still receiving very favourable reviews. Wordwise will work with tape, disc or Econet and includes automatic word counting and full control over text entered into the system. Supplied with a detailed spiral bound manual and an excellent free typing tutor program. After 6 months on the market there is still no other product as simple to use and as powerful as Wordwise.

£39.00 + £1.00 p&p + VAT



THE WORD PROCESSOR FOR THE BBC

**FREE** Typing tutor & example document



## ANDROID ATTACK

A brilliant new game. The quality of the graphics and the smooth animation make this game unsurpassed. You are in the middle of a maze being chased by various androids. your only weapons are your hand laser and a quantity of land mines. These can be dropped at any point in the maze and later detonated under remote control. Beware of the "Smiley" master android and watch your oxygen levels — the lower the level the slower you move. Many different skill levels and a high score table. This is how "SNAPPER" should have been.

£8.95 incl.



Dept. BMU7  
16 Wayside, Chipperfield, Hertfordshire. WD4 9JJ  
Telephone: Kings Langley (09277) 69727

## From Page 17

neither of the above methods is really good enough, and that other techniques are needed.

To illustrate this I'll use the block text method to display a shaded sphere moving across the screen and then discuss the limitations. Program IV

should make these apparent.

As you can see, this technique works well enough if the movement is simple and each new position is equivalent to a text position. But what if we wanted the sphere to revolve about the centre of the screen smoothly and at speed?

The first attempt may be to use graphics printing, but the removal of the

old object before printing the new one would not give a smooth effect. Try it yourself!

The answer is to move to a four colour mode and use a redefined palette, plus the logical attributes available with GCOL.

All will be explained fully in the my next *Micro User* article.

```

0 REM WALKING MAN
5 FOR IZ=224 TO 240
8 VDU23;B202;0;0;0;
10 VDU23,IZ:READ A$
15 FOR JZ=1 TO 15 STEP 2
20 VDU EVAL("&"MID$(A$,JZ,2))
25 NEXT,
30 DIM M$(3)
35 MODE4
40 VDU23;B202;0;0;0;
45 BS$=CHR$10+CHR$8+CHR$8
50 BS1$=BS$+CHR$8
55 M$(1)=CHR$32+CHR$224+CHR$32+BS1$
+CHR$32+CHR$225+CHR$226+BS1$+CHR$32+CH
R$227+CHR$228
60 M$(2)=CHR$229+CHR$230+BS$+CHR$23
1+CHR$232+BS$+CHR$233+CHR$234
65 M$(3)=CHR$235+CHR$236+BS$+CHR$23
7+CHR$238+BS$+CHR$239+CHR$240
70 WZ=10
75 XZ=0;YZ=10
80 REPEAT
85 IZ=1:PROCput
90 XZ=XZ+1:IY=2:PROCput
95 IZ=3:PROCput
100 UNTIL XZ=37
105 END
110 DEFPROCput
115 PRINT TAB(XZ,YZ)M$(IZ)
120 PROCwait(WZ)
125 ENDPROC
130 DEFPROCwait(TZ)
135 now=TIME
140 REPEAT UNTIL TIME-now>TZ
145 ENDPROC
250 DATA001B3C3C3C1B3B7C
260 DATA7C7C7E7F3D3C3C3C
270 DATA0000000080800000
280 DATA3E363733333313139
290 DATA00000000808080C0
300 DATA000307070703070F
310 DATA000808080000080
320 DATA1F3F3F1F0F0F0F0F
330 DATAB0C0C0E060B098BB
340 DATA0D0D1D3971E16121
350 DATAB0808080808080C0
360 DATA000010101000107
370 DATA00C0E0E0E0C0C0E0
380 DATA0F1F1B1B191B0B03
390 DATAF0F8CCC6C3C1C0C0
400 DATA010001030F0C0C00
410 DATAE0E0E0C0C0C0E0

```

## Program II

```

10 *FX20,1
20 FOR IZ=128 TO 180
30 VDU23,IZ:READ A$
40 FOR JZ=1 TO 15 STEP 2
50 VDU EVAL("&"MID$(A$,JZ,2))
60 NEXT,
70 DIM M$(9)
80 MODE4
90 VDU23;B202;0;0;0;
100 BS$=CHR$10+CHR$8+CHR$8
110 BS1$=CHR$10+CHR$8+CHR$8+CHR$8
115 REM Walk left to right
120 M$(1)=CHR$32+CHR$80+CHR$32+BS1$
+CHR$32+CHR$81+CHR$82+BS1$+CHR$32+CH
R$83+CHR$84
130M$(2)=CHR$85+CHR$86+BS$+CHR$87
+CHR$88+BS$+CHR$89+CHR$8A
140M$(3)=CHR$8B+CHR$8C+BS$+CHR$8D
+CHR$8E+BS$+CHR$8F+CHR$90
145REM Walk right to left
150M$(4)=CHR$32+CHR$91+CHR$32+BS1$+
CHR$92+CHR$93+CHR$32+BS1$+CHR$94+CH
R$95+CHR$32
160M$(5)=CHR$96+CHR$97+BS$+CHR$98
+CHR$99+BS$+CHR$9A+CHR$9B
170M$(6)=CHR$9C+CHR$9D+BS$+CHR$9E
+CHR$9F+BS$+CHR$A0+CHR$A1
175 REM Wave arms
180M$(7)=CHR$A2+CHR$A3+CHR$32+BS1$
+CHR$A4+CHR$A5+CHR$32+BS1$+CHR$A6+C
HR$A7+CHR$32
190M$(8)=CHR$A8+CHR$A9+CHR$32+BS1$
+CHR$AA+CHR$AB+CHR$32+BS1$+CHR$AC+C
HR$AD+CHR$32
200M$(9)=CHR$AE+CHR$AF+CHR$32+BS1$
+CHR$B0+CHR$B1+CHR$B2+BS1$+CHR$B3+
CHR$B4+CHR$32
480 DATA001B3C3C3C1B3B7C
490 DATA7C7C7E7F3D3C3C3C
500 DATA0000000080800000
510 DATA3E363733333313139
520 DATA00000000808080C0
530 DATA000307070703070F
540 DATA000808080000080
550 DATA1F3F3F1F0F0F0F0F
560 DATAB0C0C0E060B098BB
570 DATA0D0D1D3971E16121
580 DATAB0808080808080C0
590 DATA000010101000107
600 DATA00C0E0E0E0C0C0E0
610 DATA0F1F1B1B191B0B03
620 DATAF0F8CCC6C3C1C0C0
630 DATA010001030F0C0C00
640 DATAE0E0E0C0C0C0E0
645 REM Walk right to left
650 DATA001B3C3C3C1B1C3E
660 DATA000000000010000
670 DATA3E3E3E7EFCBC3C3C
680 DATA000000001010103
690 DATA7C6CECCCC8C8C9C
700 DATA000001010100001
710 DATA00C0E0E0E0C0E0F0
720 DATA01030307060D1911
730 DATAF8FCFCF8F0F0F0F0
740 DATA0101010101010103
750 DATAB080889C8E878684
760 DATA0003070707030307
770 DATA0008080800080E0
780 DATA0F1F3363C3B30303
790 DATAF0F8D8D898D8D0C0
800 DATA0707070303030307
810 DATAB0080C0F0303000
815 REM Wave arms
820 DATA000000000000FF7F
830 DATA0060F0F0F060FCFE
840 DATA0301010100010101
850 DATAFFFBFBFBFBFBFBFA
860 DATA0101010101010103
870 DATA989898989898989C
880 DATA000000000000307
890 DATA0060F0F0F060FCFE
900 DATA0F0D0D0D0C0D0D0D
910 DATAFFFBFBFBFBFBFBFB
920 DATA0501010101010103
930 DATA9A9898989898989C
940 DATA00000000000070F
950 DATA0060F0F0F060FEFF
960 DATA1B3161C180010101
970 DATAFD8FB8FB8FB8FB8F8
980 DATAB0C0603010000000
990 DATA0101010101010103
1000 DATA989898989898989C

```

## Program III

Ascii code	Memory used	X%
&20 to &3F OSHWM + &300 to OSHWM + &3FF		4
&40 to &5F OSHWM + &400 to OSHWM + &4FF		5
&60 to &7F OSHWM + &500 to OSHWM + &5FF		6
&80 to &9F &COO to &CFF		1
&A0 to &BF OSHWM to OSHWM + &FF		1
&C0 to &DF OSHWM + &100 to OSHWM + &1FF		2
&E0 to &FF OSHWM + &200 to OSHWM + &2FF		3

Table I

```

5 FOR I%=224 TO 227
10 VDU23,I%:READA$
15 FORJ%=1 TO 15 STEP 2
20 VDU EVAL("&" + MID$(A$,J%,2))
25 NEXT,
30 MODE4
35 VDU23;B202;0;0;0;
40 BS$=CHR$10+CHR$8+CHR$8+CHR$8
45 A$=STRING$(3,CHR$32)+BS$+CHR$32+
CHR$224+CHR$225+BS$+CHR$32+CHR$226+CHR
$227
50 X%=0:Y%=0:W%=10
55 REPEAT
60 PRINT TAB(X%,Y%)A$
65 X%=X%+1:Y%=Y%+1
70 PROCwait(W%)
75 UNTIL Y%=30
80 END
85 DEFPROCwait(T%)
90 N%=TIME
95 REPEAT UNTIL TIME-N%>T%
100 ENDPROC
105 DATA00031B052D180708
110 DATAE0D09C4CFC7666FF
115 DATA010624052A130900
120 DATAEEFEC44FCF0E000
    
```

Program IV

## Useful tips

● It should be remembered that different modes use pixels of different sizes. The height to width ratio is 1:1 in Mode 1 and Mode 4, 1:2 in Mode 2 and Mode 5 and 2:1 in Mode 0. This can give odd effects when using characters in modes other than the one they were designed for. It can, however, also be used to good effect...

● When using a large number of redefined characters as in program II or its extension, it can be useful to form the character set once and then save it on to tape or disc using:

- \*SAVE file1 C00 CFF
- \*SAVE file2 1900 19FF

This example would save the two character sets used in the full walking main program onto disc or tape. They could be reloaded into any program that requires them using:

- \*LOAD file1 C00
- \*LOAD file2 1900

# Electronequip

(Authorised BBC Dealer, and service centre)

### NEW PRODUCTS

- Utility Disc for BBC**  
Contains VER FORM35, FORM40 and FORM80. Cost £9.95.
- BBC Sparkjet Printer**  
New quiet printer for BBC. Friction and tractor feed 80cps. Cost £379.50
- Torch Z80 Disc Pack**  
800K dual disc drive plus Z80 processor with CMP compatible operating system. Cost £897.00
- TORCH Computer**  
800K to 21.4M disc drives. High res. colour monitor. Plus autodial modem. From £2,795.00 + VAT
- NEW Epson FX80**  
FX80 160cps printer in stock. Friction and tractor feed + proportional spacing. Cost £458.85

BBC 2	BBC Model B Micro Computer	399.00
BBC 3	BBC Model A Micro with 32K	333.50
BBC 4	BBC Model A Micro with 32K and VIA	339.50
BBC 5	BBC Model B with Disc Interface	469.00
BBC 6	BBC Model A with Econet Interface	356.00
BBC 7	BBC Model B with Econet Interface	456.00
BBC 8	BBC Model B with Disc & Econet Interface	526.00
BBC 21	BBC Model A to B Upgrade	99.82
BBC 28	Econet Upgrade for BBC	92.00
BBC 23	BBC Acorn Memory Upgrade for Model A	34.50
BBC 27	Disc Upgrade for BBC B (inc. fitting)	92.00
BBC 30	BBC 14" Colour Monitor	287.50
BBC 33	Sanyo SM12N Green Monitor 15MHz	90.85
BBC 34	BMC 12E Green Monitor 18MHz	113.85
BBC 35	Karga K12A 12" Orange Monitor	129.95
BBC 41	BBC Single 100K 5.25" Disc Drive (AND01)	265.00
BBC 43	BBC Dual 800K 5.25" Disc Drive (AND02)	803.85
BBC 44	Single Disc Drive (100K) for BBC (Teac)	205.85
BBC 45	Single Disc Drive (200K) for BBC (Teac)	263.35
BBC 46	Single Disc Drive (400K) for BBC (Teac)	343.85
BBC 47	Dual Disc Drive (200K) for BBC (Teac)	411.70
BBC 48	Dual Disc Drive (400K) for BBC (Teac)	526.70
BBC 49	Dual Disc Drive (800K) for BBC (Teac)	687.70
BBC 50	Epson FX80T 160cps Printer	458.85
ATM 2	Acorn Atom assembled 12K ram	184.00
ATM 26	Atom New Power Supply 1.8A	9.66
ATM 21	Floating Point ROM for Atom	21.85

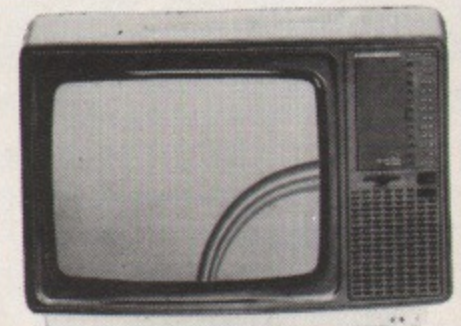

**14" Colour Portable Monitor/TV**  
This Monitor/TV is not a modified television as many TV/monitors are, but a 14" Monitor/TV which has been designed to perform both functions. It has RGB and Composite video and sound. An RGB cable for a BBC is supplied as standard.  
Cost £259.90

Trade enquiries welcome

Large stocks of software for BBC and Atom, Business, Games and Educational. Send for comprehensive list.

Large stocks. Prices inclusive of VAT. All prices inclusive of postage except micros 3.00.

All Upgrades etc. are fitted free of charge and the computer fully re-tested. Access and Barclaycard Welcome.



**ACORN  
COMPUTER**

# Electronequip

# BBC

36-38 West Street, Fareham, Hants

(0329) 230670

**QUICKSHOT  
JOYSTICK**  
Self centering type,  
works even with  
keyboard only programs.  
Runaway success at the  
BBC Micro User Show.  
**ONLY  
£19.95  
+ £1.00 p&p**

**WALK IN.  
TRY ANY  
COMPUTER  
ANYTIME.**

# Computerama

## The Midlands Home Computer Specialists

**FOR EDUCATION  
BUSINESS & LEISURE  
ACORN SAME DAY  
COMPUTER DESPATCH  
DEALER ON STOCK  
TELEPHONE FOR  
LATEST PRICE  
CHANGES**

BBC	Inc. VAT
Acorn Electron	T.B.A.
BBC Model B	£399.00
BBC Model B + Disc/Int	£499.00
BBC Disc Interface	£109.00
BBC A/B Full Upgrade	P.O.A.
BBC Teletext Receiver	£225.00
BBC 6502 2nd Processor	£299.00
BBC Z80 2nd Processor	£289.00

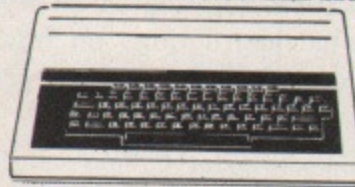

BBC DISC DRIVES	Inc. VAT
Acorn/LVL single 100K drive (expands to Double)	£265.00
Acorn/LVL dual 100K drive	£389.00
Pace single 100K drive	£212.75
Pace dual 100K drive	£388.00
Pace dual 40/80 track switchable double sided drive 800K	£699.00
Pace single version of above	£368.00
Torch dual 400k Z80 + 64K disc pack	£895.00

MONITORS	Inc. VAT
Microvitec 14" colour	£287.00
Sanyo 14" colour	£229.00
Sanyo 12" green monitor	£89.00

ACCESSORIES	Inc. VAT
Cassette Deck BBC compatible	£27.95
Cassette Leads - all types	£2.80
BBC Joysticks	£13.00
Printer Cable (Parallel)	£10.00
BBC Dust Cover	£5.95
Light Pen	£28.75
Data Cassettes C15/C20	50p/65p

PRINTERS	Inc. VAT
Shinwa CP80	£329.00
Star DP510	£329.00
Seikosha GP100A	£219.00
Epson RX80	£349.00
Epson FX80	£459.00
NEC PC8023	£368.00
Smiths Corona TPI/E	£439.00
Juki 6100 Daisywheel	£459.00

BOOKS	Inc. VAT
30 Hour Basic	£5.95
A.L.P. for BBC Micro	£8.95
BBC Revealed	£7.95
Let your BBC Micro teach you to program	£6.95
Basic Programming on the BBC Micro	£5.95
Creative Graphics	£7.50
Graphs & Charts	£7.50
Lisp Manual	£7.50

Forth Manual	£7.50
35 Educational Programs for the BBC	£6.95
30 Progs BBC	£4.95
Further Programming for the BBC Micro	£5.95
Programming the BBC	£6.95
Using Floppy Discs with the BBC	£10.00
6502 M/C for Beginners	£5.95
Programming 6502 (Sybex)	£10.75

A&F SOFTWARE	Inc. VAT
Painter	£8.00
Planes	£8.00
Frogger	£8.00
Lunar Lander	£6.95
Pharaohs Tomb	£8.00
Tower of Alos	£6.95

APPLICATIONS	Inc. VAT
Wordwise ROM	£44.85
Beebcalc ROM	£39.00
Disc Doctor ROM	£21.85
Printer Tool Kit ROM	£21.85
Debugging Program ROM	£21.85
Pace DFS	£34.45

### PROGRAM OF THE MONTH

747 Flight Simulator  
£6.95

Each month we recommend a superb new game.

CLARES	Inc. VAT
Graphkey	£7.95
Replica (disc only)	£9.95
Graph Disc	£12.95
Beebsynth	£7.95
The Key (disc only)	£12.95



## FOUR COLOUR PRINTER/PLOTTER



- High resolution graphics.
  - Alpha numeric printing.
  - 40 and 80 column
  - 12 CPS
  - Black, blue, green and red colour pens
  - Complete with eight pens + paper roll
- ONLY £169.00**

I.J.K. SOFTWARE	Inc. VAT
Atlantis	£7.50
Leapfrog	£7.50
Hyperdrive	£6.50
Invaders 'B'	£7.50
Mutant/Breakout	£6.50
Strato Bomber	£7.50
3D Maze 'B'	£4.50

PROGRAM POWER	Inc. VAT
Moonraider	£7.99
Cat & Mouse	£5.70
Chess Model B	£7.99
Cowboy Shoot Out	£6.85
Croaker	£7.99
Eldorado Gold	£6.85
Galactic Commander	£7.99
Junior Maths	£6.85
Laser Command	£7.99
Martians	£6.85
Maze Invaders	£5.70
Munching Man	£6.85
Seek	£6.85
Swoop	£7.99
Time Trek	£7.99
World Geography	£6.85
Where	£6.85
Micro Budget	£7.99

BUG BYTE	Inc. VAT
Dragon Quest	£11.50
Golf	£5.50
Polaris	£5.50
Space Warp	£9.00
Music Synth	£9.50
Galaxy Wars	£7.50
Sea Lord	P.O.A.
City Defence	£7.50

### BBC/ACORNSOFT

	Inc. VAT
Castle of Riddles	£9.95
Algebraic Manipulation	£9.95
Arcade Action	£11.90
Arcadians	£9.95
Business Games	£9.95
Chess	£9.95
Creative Graphics	£9.95
Countdown to Doom	£9.95
Cube Master	£9.95
Desk Diary	£9.95
Forth	£16.85
Graphs & Charts	£9.95
Lisp	£16.85
Missile Base	£9.95
Meteors	£9.95
Monsters	£9.95
Peeko Computer	£9.95
Philosophers Quest	£9.95
Planetoid	£9.95
Rocket Raid	£9.95
Sliding Block Puzzles	£9.95
Snooker	£9.95
Sphinx Adventure	£9.95
Starship Command	£9.95
Super Invaders	£9.95
Tree of Knowledge	£9.95
Snooker	£9.95
View	£59.00

### MAIL ORDER

Post your order today to:  
**Computerama, 1 Sash Street,  
Stafford ST16 2PS.**  
Or telephone your Access or  
Barclaycard number, we will  
despatch immediately (0785) 41899.  
Call in today. See the Midlands  
Home Computer Centre for the BBC  
enthusiast.  
Send large S.A.E. for further details  
of any product.

### CARRIAGE COSTS

Micro's, Monitors, Disc Drives,  
Printers £8.00. Books £1 each.  
Cassette Decks £2.00. Leads and  
software 50p/item.

# computerama

The Midland's Home Computer Specialists.

**STAFFORD**  
59 Foregate Street, Stafford,  
ST16 2PR. Tel: (0785) 41899

**STOKE-ON-TRENT**  
11 Market Square Arcade,  
Hanley, Stoke-on-Trent,  
ST1 1PD.  
Tel: (0782) 268620

**BBC**

SERVICE  
INFORMATION  
CENTRE

**SHREWSBURY**  
13 Castle Gates, Shrewsbury  
SY1 2AB. Tel: (0743) 60528



# Where infants pick up a micro instead of a crayon

THE BBC Micro has at last reached the infants' classroom. At Hollingwood Lane First School, Bradford, it has become an integral part of daily life, with children from the youngest child upwards using the micro as naturally as they would a book or crayons.

Headmistress Wyn Moore, the authoress of a highly respected series of mathematics textbooks for infants and juniors, was quick to see the educational potential of the BBC Micro.

When she heard that her local education authority was giving courses on the use of the micro – mainly for teachers of older age groups – she joined one, and then persuaded the authority to lend her a machine.

"Two workmen came in and just left

it. That's when the anguish started." Unfortunately they delivered a machine with a disc interface, but no accompanying drive. This, of course, required \*TAPE entered before it would work on a cassette system.

However, if you don't know what a DFS is, and have just started Basic, you wouldn't know that, would you?

Fortunately Wyn has two computer-literate sons who helped her over the initial hurdles, though they could not spare her the frustration of trying to find a compatible cassette recorder.

Once she had sorted that out all she had to do was run the software. "But, save for the Welcome tape, there wasn't any," she said.

Bradford LEA, however, had seconded Paul King, an experienced middle school teacher, specifically for

the purpose of compiling a bibliography of educational software. He came to her aid with a version of Logo.

Wyn quickly saw the potential: "But it needed putting into an educational context. Children need to learn, for instance, that left and right are relative terms.

"When someone is coming towards you, and you ask them to turn left, they will go to your right. Children need to appreciate this to be able to use LOGO's turtle effectively".

She and her enthusiastic staff set to work to prepare a series of activities geared to teaching children the use of language describing spatial movements. The BBC Micro was just one part in this.

Eventually they developed more than 30 such activities, involving almost every spatial skill imaginable, from simply telling your left hand from your right, to attempting to give your partner verbal instructions on how to cut out a complex shape from graph paper.

There were mazes, closed and open, a lovely animated "snail's journey", left-right patience, homes for Mr Men and lots of others that the children obviously enjoyed.

Much of the equipment was homemade, some games involving ingenious uses of standard school equipment such as attribute blocks.

Wyn and her helpers also devised three or four programs to help with the process. "They're primitive, but we're learning," she said.

The programming techniques might not be the most sophisticated, but their educational validity, unlike so much of educational software, is impeccable.

High point of my day was seeing five-year-old Andrew typing in his answers to the computer, and editing them with the ease of a veteran. He was "hiding" in a house, and the BBC Micro was interrogating him to find out where.

It wasn't having too much success, but just to be on the safe side, Andrew kept the card with the answer on well hidden!

"The trouble is," said Wyn as I left, "there just isn't enough software. One of our colleagues went to an educational exhibition specifically to buy software, and couldn't find a single item."

I know what she means. But with a school like hers working on the problem things are already beginning to look up.

Clive Kelly



# DISC USERS

## – IF YOU USE DISCS YOU NEED "THE KEY"

A suite of disc utility programs:

1. FORM 40 – Format 40 track discs.
2. FORM 80 – Format 80 track discs.
3. BACKUP – Allows your valuable discs to be backed-up, including most protected discs.
4. EDITOR – Allows the user to alter and customise programs, even those which are not listable.
5. RETRIEVE – Enables the user to recover data or programs that have been accidentally erased.

The real workhorse of the package is EDITOR which allows the user to see a sector in HEX and ASCII, and to then alter that sector and write it back to disc. There is provision for automatic and manual searches of the sector and the instructions contain useful tips on what to look for, and where to look for it. The sector can also be dumped to printer for in-depth analysis.

The program is very easy to use and control is mainly through the function and cursor keys, whilst on-screen prompting provides all the necessary information. One recovered program or a back-up copy that is actually needed will pay for this package, and will continue to show its worth time and time again.

This is the sort of utility that should be provided with every disc drive sold as it becomes indispensable once used. At a price of £12.95 "THE KEY" represents very good value when compared with the many formatting programs being sold for around £10.00

**THE KEY – £12.95** (state 40 or 80 track discs)

*It is a condition of sale that this program will not be used illegally.*

### C.A.D. SOFTWARE

Ideal for teachers, designers, artists, technical drawing and numerous other applications including your own form and stationery design etc.

This program must be seen to be appreciated – your imagination is the only factor to limit its individual applications.

- Modes 0,1,2,4,5 (can be changed when program is running).
- Multiple display of arrays enables infinite complexity.
- **FUNCTIONS:** Line, rectangle, triangle, circle, text (upper and lower case) and colour pallet (8 colours and flashing).
- **DRAWING AIDS:** Alignment grid, circle copy, delete, free memory, purge memory, variable cursor speed, clear screen and redraw.
- Shapes can be filled or outlined (no need for Fill Routines).
- Save and load to tape in about 20 seconds, or to disc in 2 seconds.
- SPECIAL FACILITY – Rubber band mode – A very flexible and variable line drawing facility – must be seen.
- Free "redraw" routine to enable the pictures created to be displayed in your own programs.
- The disc version allows screen saves, which take approx. 3 seconds.
- **Recommended by BBC Micro User.**
- GRAFKEY (keyboard and joystick cassette version) **£7.95**
- GRAFDISC (disc version) **£12.95**

### REPLICA

(Another disc utility program to make your life easier)

This program allows most of the popular machine-code and Basic programs on cassette to be uploaded onto disc and run. The program is very user friendly and almost does away with the need for human intervention. It is presented in such a way that the user does not need to know what is going on, he simply inserts the tape to be saved and presses a few buttons when prompted. The programs are presented in a menu, which is created by Replica, just leaving the user to select the required program. Many types of program can be handled with this utility and it is particularly suited to programs that load in several stages or sections. The disc will allow approximately 8-10 programs of similar length to the Acornsoft arcade game to be stored. If additional program space is required, a further disc must be purchased.

**REPLICA £9.95**

(state 40 or 80 track)

### SYNTHESISER (requires PACKAGE 1.2 O.S)

**PART 1:-**  
Allows up to 16 envelopes to be defined and saved using a very sophisticated, yet easy to use defining program. Alter the values and hear the effect instantly. Then use the envelopes in Part 2.

**PART 2:-**  
Turns your keyboard into a musical instrument. Lets you play 3-note chords (not just single notes). Use cursor keys to change octaves etc, etc.

Become the Rick Wakeman of the Computer Age.

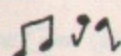
THIS SUPER PACKAGE COSTS JUST  Cassette **£7.95**  
Disc **£10.95**

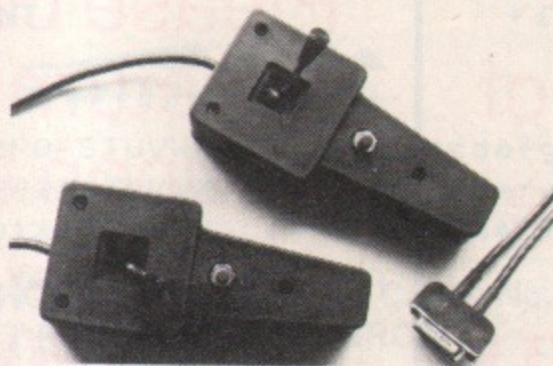

### JOYSTICKS

Pair of fully proportional joysticks of compact and handy size  
**£17.95**

### JOYSTICK UTILITY

Converts non-joystick programs to work with joysticks. Works with any program using INKEY(-), which applies to most programs. Easy to use, just press the keys you want to transfer. Supplied on cassette but can be transferred to disc.

**CASSETTE £5.00**

### EDUCATIONAL CORNER

(for the 5-11 age group)

**THE GARDEN** – 3 programs with superb graphics. Covers: colours, spelling and understanding. Cassette **£6.95**

**COUNTING** – robots, rockets, flowers, etc. Excellent graphics, good range. Cassette **£4.95**

**MATCHING** – 4 programs covering numbers, words, shapes and patterns. Cassette **£5.95**

**COLOUR MATCHING** – A superb teaching-aid, using animation techniques in Mode 7. A hit with adults and children alike. Cassette **£4.95**

**INTRO** – A simple programming language which uses the immediate visual response of "Turtle" graphics to introduce a number of programming concepts and techniques. Cassette (and 9 page manual) **£7.95**

### PROGRAMMERS

We are constantly seeking new and interesting programs. Why not send yours for appraisal? Do not worry if the presentation is not to professional standards – we are looking for new ideas and we will advise and assist in bringing your program to the required standard. You have got nothing to lose but much to gain – So why not send your program today? 40 Track disc if possible or two copies on cassette. In some cases we will even provide disc drives against future royalties.

### CLARES MICRO SUPPLIES



Dept. BMU8, Providence House,  
222 Townfield Road, Winsford,  
Cheshire CW7 4AX.  
Tel: 06065 51374

All prices inclusive of VAT + Carriage – No Extras.



# CUMANA

## the 5<sup>1</sup>/<sub>4</sub>" Disk Drive Company

Visit us on  
**STAND 38**

at the  
**ACORN USERS SHOW**  
and take away a bargain

Read the next issue of  
this magazine for the  
**NEW PRODUCT DETAILS**

Please complete and  
return the reply  
coupon for advance  
information on our  
**NEW PRODUCT RANGE**

# CUMANA LTD

The Pines Trading Estate,  
Broad Street, GUILDFORD, Surrey. GU3 3BH.  
Tel. (0483) 503121 Telex: 859380

For further details complete & return this coupon.

Name .....

Address .....

Tel. No .....

Interests:

Dealer

Education

Business

Home Use

Please send:

Brochure

Data Sheets

Dealer Address List



# IF OUR ADVERT DOES NOT CONVINCE YOU THE FREE PRINTOUT SAMPLE WILL.

## SHINWA-CTI CP80

FULL FEATURED 80 COLUMN MATRIX PRINTER

PROBABLY THE BEST PRINTER AVAILABLE IN THE WORLD  
BELOW £300!!

COMPATIBLE CENTRONICS INTERFACE  
AND INDUSTRY STANDARD CONTROL  
CODES MAKES THE CP 80  
IDEAL FOR:-

BBC, DRAGON, ORIC,  
APPLE, NEWBRAIN,  
SIRIUS and many more.

OPTIONAL RS232  
INTERFACES AVAILABLE  
BOTH UNBUFFERED  
AND BUFFERED



Made in Japan

EX STOCK  
**£289 + VAT**  
FREE 24HR  
DELIVERY!

FULL ONE YEAR WARRANTY

### SPECIFICATIONS

- |  |                                |
|--|--------------------------------|
| + 80 COLUMN                            | + <u>AUTO UNDERLINING</u>      |
| + FRICTION AND ADJUSTABLE TRACTOR FEED | + VERTICAL AND HORIZONTAL TABS |
| + BIDIRECTIONAL LOGIC SEEKING          | + BACKSPACE                    |
| + HI-RES GRAPHICS AND BLOCK GRAPHICS   | + SELF TEST                    |
| + SUB AND SUPERSCRIPTS                 | + ITALIC PRINT STYLE           |
| + 9 X 9 DOT MATRIX - TRUE DESCENDERS   | + EXPANDED PRINT               |
| + CONDENSED PRINT                      | + DOUBLE PRINT                 |
| + EMPHASISED PRINT                     | + £ AND # S                    |
| + GRAPHICS SET -                       |                                |

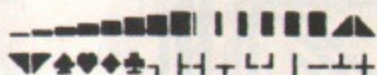

@ABCDEFGHIJKLMNPOQRSTUVWXYZ[\]^\_ 'abcdefghijklmnop  
@ABCDEFGHIJKLMNPOQRSTUVWXYZ[\]^\_ 'abcdefghijklmnop  
!"#\$%&'()\*+,-./0123456789:;<=>? !"#\$%&'()\*+,-./012

NO DELAY! - TELEPHONE YOUR CREDIT CARD No. TODAY  
AND YOU CAN START PRINTING TOMORROW

- AND IF YOUR NOT SATISFIED RETURN WITHIN 14 DAYS  
FOR A FULL REFUND.



HAMPTON COURT  KEY  WALTON

OPEN 6 DAYS A WEEK  
MON - SAT 9am to 7pm (6pm SAT)



### COMPUTER CENTRES LTD

Enterprise House 44 Terrace Road,  
Walton-on-Thames, Surrey KT12 2SD

Telephone: Walton-on-Thames  
**(09322) 42777**

( 4 lines )

TO KEY COMPUTER CENTRES

Please send me FREE print out samples  
and literature.

Name .....

Address .....

Post Code .....

# BATTLE of

THE two buggies in the ring are, in the red corner, from Economatics, weighing in at £160, the BBC Buggy. And in the blue corner, from Jessop Microelectronics, weighing in at £350, the Edinburgh Turtle.

A buggy is a small, wheeled creature that can be controlled by your micro. Its main function in life seems to be driving your dog to distraction.

That aside they can be great fun, and there is educational value in them as well.

The Edinburgh Turtle is constructed inside a hemispherical dome of Perspex and consists of two ironless-rotor motors with optical pulse feedback, a pen lowering mechanism and loud-speaker.

When it is powered up it gives a

The referee is  
MIKE COOK

rendering of Scotland the Brave.

The umbilical is a round section multicore cable which fits into a 15 way D type socket on top of the dome. This plugs into a control box which contains its own power supply along with a controlling microprocessor. The control box then plugs into the RS432 socket in the BBC Micro.

A glance will tell you that it is a precision engineering product and, as it has its own microprocessor, it is not restricted to being used on any one computer. It comes with OK Logo

software, a Logo-like language written in Basic.

This allows the Turtle to be used to draw shapes with a pen as it moves around the floor.

Logo is a language that has taken off in schools, especially primary schools, where it is used to teach children about geometry and problem-solving in a stimulating and exciting way.

It basically consists of commands to move the Turtle forward or backward a certain amount or to turn it through a number of degrees.

Using this, the children build up procedures which make the Turtle move and draw what they want. For example, they can be given problems to work out such as trying to get the Turtle to produce a hexagon.

Here accuracy is important, as younger children are not willing to accept a line that does not quite join up.

The rival Buggy has two stepping motors, several sensors and a pen holder attached to a relay. Its umbilical wire is 20 way ribbon cable leading to a small circuit board. This contains a 10 LED bar display and leads going to the user port, the analogue port and the power supply.

In contrast to the precision engineered Turtle, the Buggy gives the impression of being made from a child's construction set - which it was!

The Buggy is controlled directly from the BBC Micro and comes with 13 programs. They are written in Basic and are listable. However, there is not a great deal of difference between one program and the next, although I think they are designed to show an increasing level of sophistication.

One allows Logo-like commands to be used and, in addition, the Buggy's position is shown graphically on the screen.

Where the Buggy really scores over the Turtle is in its sensors. There is an adjustable probe on the front for placing an infra-red bar code reader and light dependent resistor. In addition, there are two micro switches connected to bumpers on the front.

Using these, the Buggy can sense

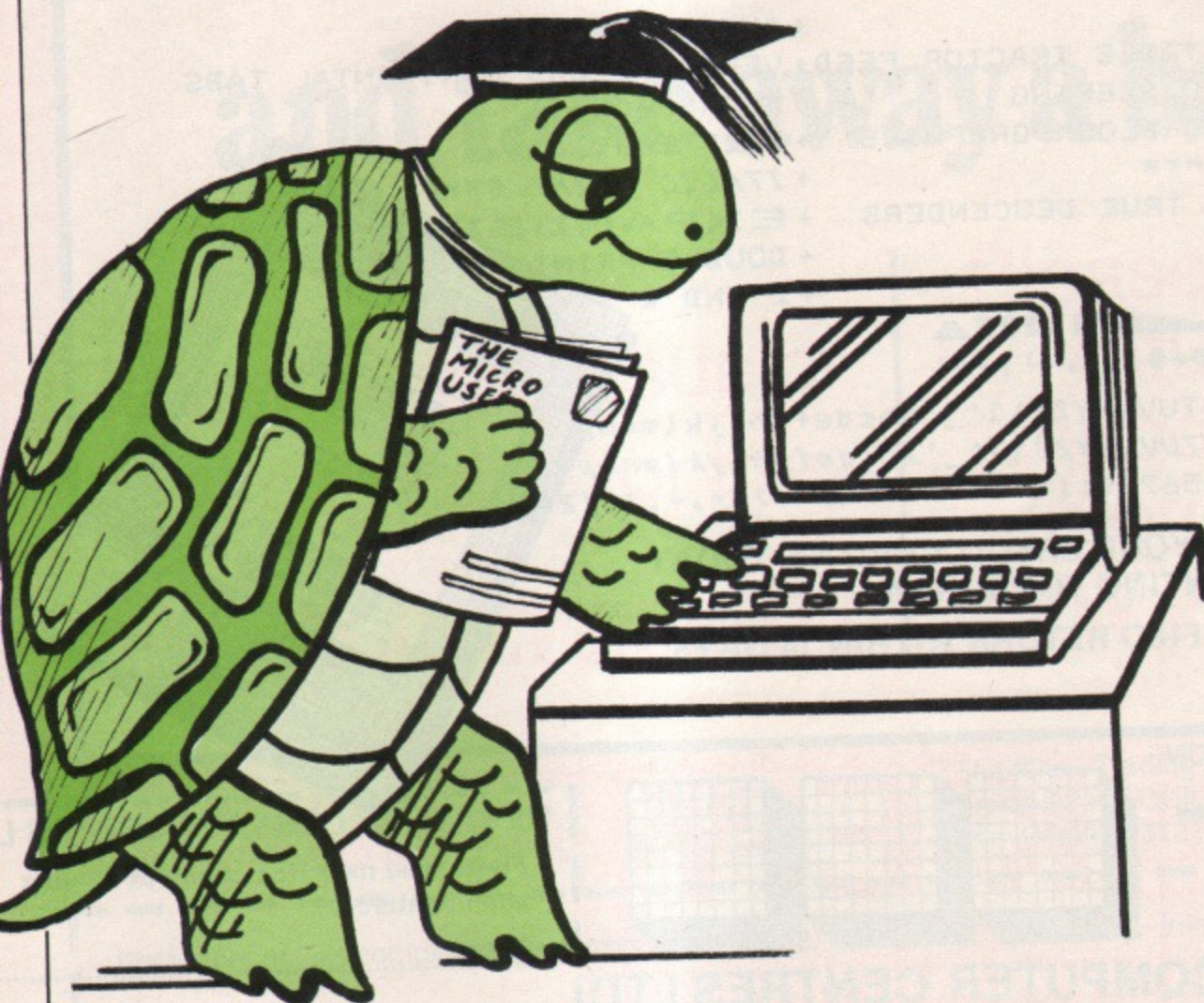

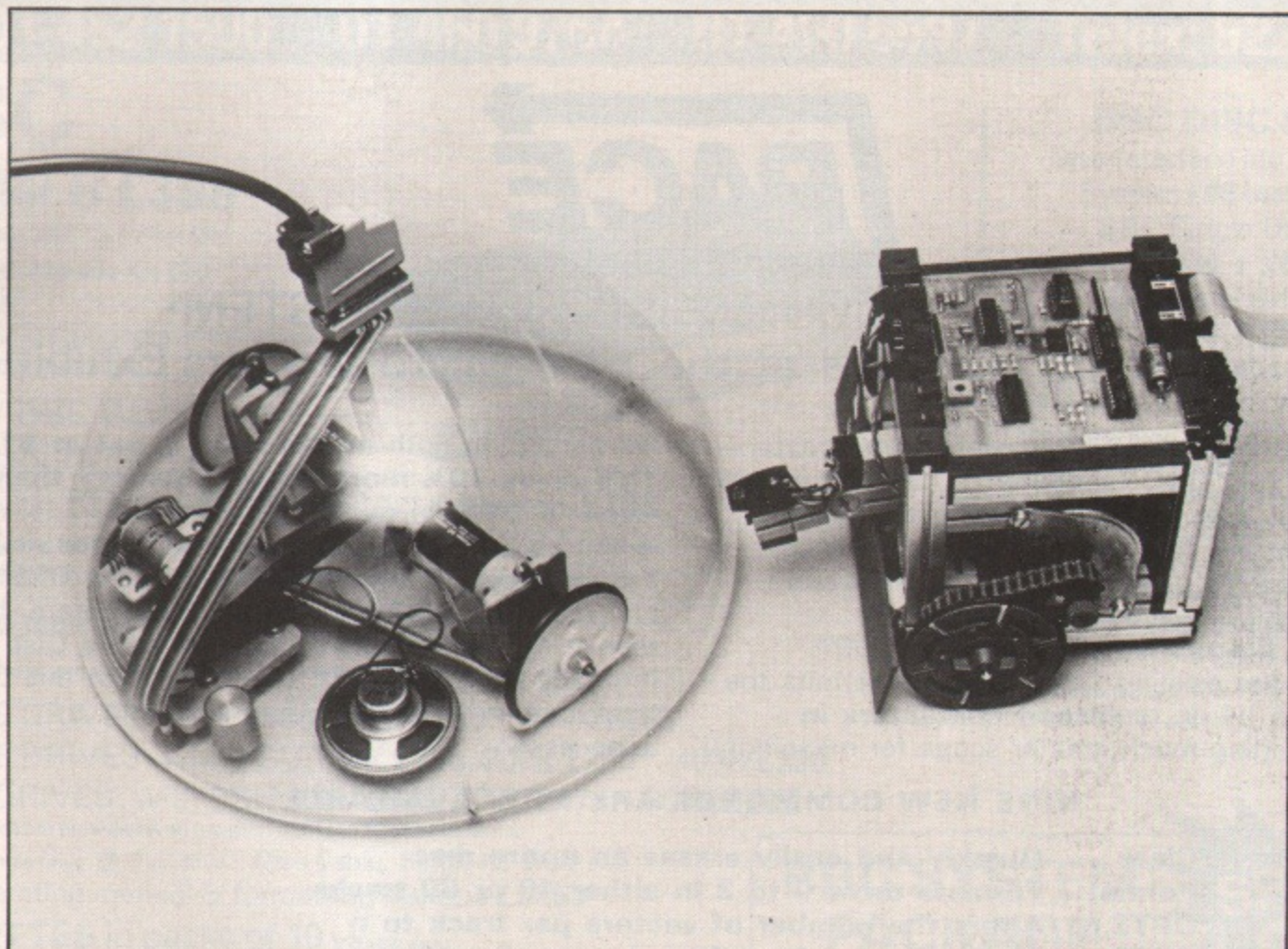

*Fact to face:  
On the left,  
the Edinburgh  
Turtle.  
On the right,  
the BBC  
Buggy*

# the BUGGIES

something about its surroundings.

However, in practice I found the bar code reader difficult to adjust for proper operation and it kept getting in the way of the bumpers doing their job.

The stepping motors on the Buggy get very hot after a few hours' operation and you cannot bear to leave your fingers on them. Stepping motors actually get hotter when they are standing still than when they are moving.

I was pleased to see the Turtle is totally enclosed and uses a type of motor which does not get as hot, so the problem will never arise.

The dome of the Turtle allows it to shed its cable easily and prevents it from becoming entangled, whereas the Buggy has a habit of getting tangled up unless you hold the cable clear.

The Buggy's actions are jerky, and backlash in the plastic chain arrangement tends to reduce its accuracy.

By contrast the Turtle moves smoothly, slowing down just before it stops. Both need a fairly smooth surface to trundle over, but the Buggy can

cope with slightly rougher terrain than the Turtle.

The Turtle's pen in particular does not like going over overlaps in paper, and so all drawing has to be done on one large sheet. In the Buggy's test program the 360 degree turn is about 15 degrees under, but I suspect this is a software fault.

Both can be used in your own programs, but the Buggy is a little more complicated to drive, because it requires a program which constantly outputs pulses to make it move. This

**THE** manufacturers of the Edinburgh Turtle, Jessop Microelectronics, have announced a new, low cost version. The price during a special summer promotion is £145 — less than half the previous price of £350.

The reduction has been made possible by running the turtle from software in the BBC Micro itself via the user port, which obviates the need for a microprocessor inside the Turtle. The new Turtle also gets its power direct from the BBC Micro.

means you have to keep stopping the Buggy so that the program can look at the sensors, or incorporate a sensor scan in the loop outputting the pulses.

The Turtle, instead, is sent a command and the computer is then free to sort out the next one, or whatever, while the controlling microprocessor looks after the movement.

In conclusion, I think the accuracy of the Turtle, along with its tangle resistant shape, will make it more suitable than the Buggy for young children.

On the other hand, the sensors on the Buggy make it suitable for a larger variety of applications more appreciated by older children. Also, the older children will perhaps be more tolerant of the small inaccuracies of movement and more careful to avoid being burnt on the stepping motors.

Both machines show how difficult it is to get a device to move in exactly the way you want and in so doing enhance your sense of spatial geometry and develop problem solving skills.

They are also a lot of fun!

BBC MICRO OWNERS LOOK  
**AT LAST ... THE REAL ALTERNATIVE D.F.S.**  
Available NOW!!! from



**THE NEW AMCOM DISC FILING SYSTEM**  
As successfully launched at the BBC Micro Owners Exhibition

This amazing new disc filing system adds greater flexibility to your BBC Computer. It has two distinct modes which auto select on booting the system. Mode zero is the standard mode which retains compatibility with presently available software. Mode one, the extended mode, allows for **sixty-three file names** per disc, over 100% increase on the existing DFS, and also permits the file names to be up to **fifteen characters in length**, providing much greater scope for meaningful

file names. In both modes **page is set at \$1500.** **This gives 10% more usable memory than Acorn's DFS,** in modes 0, 1 and 2.

If you already have a Disc Interface fitted, it is very easy to upgrade, you simply remove the DFS Eprom and replace it with the Amcom DFS Eprom, if not then it is possible to purchase an entire Disc Interface kit (consists of 11 I.C.'s). With this DFS no track cutting is required, and soldering is unnecessary.

**NINE NEW COMMANDS ARE NOW AVAILABLE**

- \*Clear** Quickly and easily erases an entire disc
- \*Format** Formats drive 0 to 3\* in either 40 or 80 tracks
- \*OPT2,n** Alters the number of sectors per track to n
- \*OPT3,n** Alters the number of tracks per disc to n
- \*OPT5,n** Sets the start address of the DFS buffer (see OPT7)
- \*OPT6,n** Provides control over which part of the file spec. will be displayed ie. only display directory and program length, or just display drive and load address etc
- \*OPT7,n** Sets the length of the DFS buffer
- \*OPT8,n** allows 80 track drives to read 40 track diskettes
- \*SYS** Selects either Acorn mode or Extended mode

There is a built-in formatter which will format in either forty or eighty tracks in both modes of operation. This formatter also allows for user definable parameters to be included for the development of software protection. With this disc filing system a user definable buffer can be used while compacting the disc. This will enable disc compacting to be carried out without overwriting any program in memory. Alternatively a new disc may be formatted without any resident program being overwritten. This DFS allows for the use of wildcard characters, using either the # symbol for a single wildcard and the \* character for multiple wild characters. (e.g. CHAIN P\* could be used to chain a program called PRINTER as long as there are no other files whose names begin with P). Has many friendly features such as assisting in transfer of cassette files to disc. This DFS is totally compatible with

Econet etc., and is complete with a utilities disc and comprehensive manual. The utilities disc contains many useful programs including Machine Language, printer screen dumps in all modes, including High Res. (Epson & NEC 8023). It also has a nibble editor to scan discs, read data, edit them, and then write back to the disc. Also included is an eight way DIL switch which may be used to select the start up options, these are:

- Link 1, Determines if the system starts up in 40 or 80 tracks.
- Link 2 & 3, Selects type of drive ie. Shugart, Canon etc.
- Link 4, Selects Acorn or Extended mode at start up.
- Link 5, Selects auto-boot or not, on "break".
- Link 6-8, Selects screen mode on start up, ie, mode 0 to 7 etc.

Available now direct from  or contact your local dealer.

Comes complete with Disc, Manual, 8 way DIL switch and full fitting instructions.

**DISC FILING SYSTEM £34 inc. VAT** or as a  
**Complete Disc Interface Kit (inc. DFS) £95 inc. VAT**

**PACE SOFTWARE SUPPLIES,**  
92 NEW CROSS STREET, BRADFORD.



**0274 729306**



SEE OUR ADVERT ON PAGE 44  
FOR COMPLIMENTARY RANGE OF DISC DRIVES

# Technomatic Official BBC Dealer

01-452 1500

01-450 9764

01-450 6597

Telex: 922800

## BBC

### Model B £399

(price includes VAT. Carr. extra £8)

Complete Upgrade Kit **£50**

Installation **£15**

Individual Components and Connectors available.

'VIEW' BBC Word

Processor ROM **£52**

Wordwise ROM **£34.50** Teletext Adaptor **£196**

Wide Range of Business, Education and Fun Software from **ACORNSOFT, PROGRAM POWER AND GEMINI** in stock.

### BBC COMPATIBLE 5¼" DISC DRIVES

These drives are supplied in BBC matching colour cases.

SINGLE DRIVES: 100K **£150** 200K **£215\*** 400K **£265**

SINGLE DRIVES: with PSU 100K **£185** 200K **£260\*** 400K **£330**

DUAL DRIVES: with PSU 200K **£355** 400K **£475\*** 800K **£595**

\* These drives are provided with a switch between 40 and 80 tracks.

Carr. £6/Single drive £8/Dual drive. Disc Cable: Single £8 Dual £12

Disk operating manual & formatting diskette **£17.50**

### DISKETTES in packs of 10 (p&p £2/pack)

Single Sided 40 tracks **£15** Single Sided 80 tracks **£24**

Double Sided 80 tracks **£32** p&p £2/pack

Lockable Box 30/40 discs **£21** 60/70 discs **£32**

Library Case **£2** Drive Head Cleaning Kit: Safe Kit **£30.00**;

Floppyclene **£19.50 + £2 carr.**

**SEND or PHONE FOR OUR  
BBC LEAFLET**

## PRINTERS

### NEC PC8023 BEC

• 80 Cols. 100 CPS • F&T Feed  
**£345 + £8 Carr.**

### EPSON RX80 & FX80

• RX80 100 CPS 80 Col. Tractor Feed  
• FX80 160 CPS 80 Col. F&T Feed. Full specifications on request.  
RX80 **£298** FX80 **£389** MX100 F/T3 **£425** Carr./Printer **£8**

**SEIKOSHA GP100A £180 + £6 Carr.**

**GP250A £250 + £8 Carr.**

Parallel Printer Lead **£13.50**; Serial Printer Lead **£13.50**

2000 sheets 9½" x 11" Fanfold Paper **£13.50 + £3 p&p**

Epson/NEC Serial Interface **£60**.

## MONITORS

Microvitec 1431 14" RGB  
**£249 + £8 Carr.**

Microvitec 2031 20" RGB  
**£319 + £10 Carr.**

12" Hi Res Green Monitor  
**£99 + £6 Carr.**

Also available Sanyo &  
Kaga RGB Monitors

*Please send SAE for our detailed price list of electronic and computer components*

We carry a wide range of connectors and assemblies, Microprocessors, RAMs, EPROMs, Crystals, etc.

Price Lists, Leaflets available on request. Large stocks enable same day despatch on most orders. Please check for delivery details.

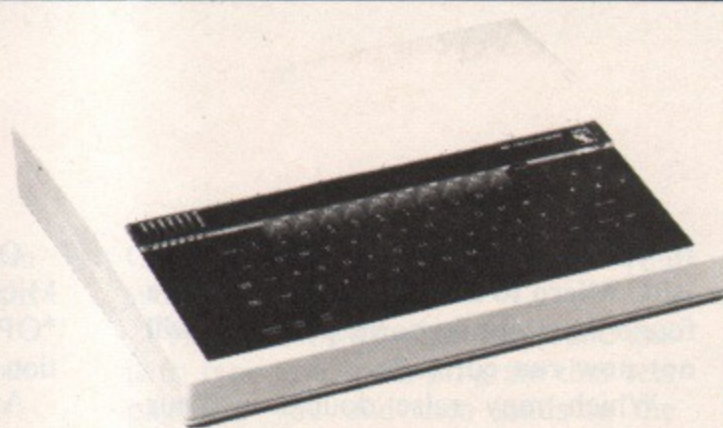

### BBC DISC SYSTEM

Disc Interface inc. 1.2 operating

System **£95** Installation **£20**

BBC Single Drive (100K)

**£230 + £6 Carr.**

BBC Dual Drive (800K)

**£699 + £6 Carr.**

### BOOKS (No VAT - £1 p&p/Book)

Basic Programming on BBC **£5.95**

30 HR Basic (NEC) **£5.95**

Let your BBC teach you to Program **£6.95**

BBC Micro Revealed **£7.95**

Assy. Lang. Program on BBC **£8.95**

Program the 6502 **£10.75** 6502 Games **£10.75**

6502 Software Design **£10.50**

BBC Micro An Expert Guide **£6.95**

Games BBC Computers Play **£6.95**

plus many more in stock.

## BBC SYSTEM PACKAGE

**SPECIAL OFFER**

This package comprises of a BBC Model B computer fitted with disc interface and W.P. ROM 800K dual drive, NEC PC 8023 Printer and 12" Green Screen Monitor. The system is supplied complete with all manuals, connecting leads and software for stock control, invoice and statements and mailing lists.

Package Price **£1,500** a saving of **£139**.

The SMARTMOUTH - a speech synthesiser ready to plug into the user-port, having an unlimited vocabulary, yet simple to use. Very economical in memory usage - typical words using 5-10 bytes. (Has Aux. audio output socket).

SMARTMOUTH is supplied complete with demo and development programs on cassette, and full software instructions. **£37 + £2 p&p**.

### BBC Compatible Cassette Recorder

SANYO Data Recorder

DR 101 A superior quality data recorder with dedicated computer output and monitoring facility on both RECORD & PLAY. **£39.50 + £1.50 p&p**

SLIMLINE Cassette Recorder

complete with counter and remote

control **£24.00 + £1.50 p&p**

Cassette Lead **£3.50**

Computer Grade Cassettes **50p** each or 10 for **£4.50**

## TECHNOMATIC LTD

MAIL ORDERS TO: 17 BURNLEY ROAD, LONDON NW10 1ED

SHOPS AT: 17 BURNLEY ROAD, LONDON NW10

(Tel: 01-452 1500, 01-450 6597. Telex: 922800)

305 EDGWARE ROAD, LONDON W2

PLEASE ADD 50p p&p & 15% VAT

(Export: no VAT, p&p at Cost)

Orders from Government Depts. & Colleges etc. welcome.



Detailed Price List on request.

Stock items are normally by return of post.



# TAPE TOPE DOPE DOSE DOSS DISS DISC

If you have recently upgraded your BBC Micro to use discs, you may have found that your favourite programs will not now run correctly.

Which may raise doubts in your mind as to why you have paid a small fortune for this new fangled gadget when most programs will not work with it!

Well fear not, because they will.

After getting your computer back from the upgrade, and switching on, then wondering about your new message "Acorn DFS", all seems to be normal.

But all is not. Your machine is now switched into the Disc Filing System. So when you try to load a program from cassette you can't get the tape to go around.

Typing \*TAPE, puts you back into the tape system. This is not the only change that has taken place. The disc system grabs some of your precious memory space - it has moved the start of basic memory to &1900.

To get it back type PAGE=&E00. You can now use your machine to load and run cassette programs.

So to run a tape program after switching on, or after pressing BREAK you type:

```
*TAPE  
PAGE=&E00
```

Before we find how to run programs from disc, you first must know how to transfer programs from tape to disc correctly.

One command built into the BBC Micro is invaluable for doing this - \*OPT1,2. This gives you vital information about the program on tape or disc.

After \*OPT1,2 has been set the computer, once it has loaded the program, will display various numbers on the screen, such as:

```
Program_name AA BBBB CCCC DDDD
```

The letters mean:

AA = Number of blocks on the tape.  
BBBB = Length of the program.  
CCCC = Start address of the program.  
DDDD = Execution address of the program used for \*RUN OR CALL &DDDD.

To copy this program type:

```
*TAPE  
*OPT1,2  
*LOAD"Program_name"1100  
*DISC  
*SAVE"PROGRAM_NAME"1100+BBBB DDDD
```

If the start address is above &1100 the program should be loaded using:

```
*LOAD"Program_name"CCCC
```

and saved using:

```
*SAVE"Program_name"CCCC+BBBB DDDD
```

But if this is a program which you just use LOAD or CHAIN, then you still must use the first method of copying it, not the second. I must add that it is illegal to make a copy of your

## Painless switch from cassette to disc

By PETER WALKER

program for any other person than yourself, as this infringes the copyright laws.

So now let's find out how to get your programs to work off disc.

Firstly load it from tape and try to run it. You may be lucky. If it does work just type, \*DISC or \*D., to put the machine back into disc system and SAVE it as normal.

You should now be able to type CHAIN"program\_name" and it should work.

If, when you loaded it from tape, it did not work, there are a number of things you must check before proceeding further.

● *Are there any CALLs to machine code?*

Find out by listing the program if you can, and searching through it. If there are any you must use the second method to get it to work.

● *Is the program run by \*RUN?*

Again, this is easily found out. In certain cases one program will load and run another.

This will have CHAIN or CH. if it is in Basic and \*RUN if it is machine code. If this is the case you must use my second method to get it to work.

Programs which produce an error message like "Bad Mode" or "No room", may be run by setting the page lower in memory.

When in DFS you lose over 2k of memory, but the disc does not use all of it. For example if you do not use any file handling commands such as OPENIN, BPUT, BGET etc, you can move the Basic memory down to &1300.

But if you don't use the commands \*SPOOL or \*EXEC, this can be moved down to &1100, so retrieving 2k of memory, leaving the DFS to use 3/4k for its work space.

**METHOD I:** Move the page down to &1100 by typing PAGE=&1100 and try to run it. (If it still does not work move onto Method II.)

If Method I works you still have to type in the page command, which means that you can't just type

CHAIN"program\_name", after you switch on.

The easiest way of getting round this is to type in a small program that sets page for you and then loads in the program:

```
10 PAGE=&1100
20 CHAIN"Program_name"
```

When this program is run it will move the page down and run the main program for you automatically.

**METHOD II** is the more versatile of the two, because it will get almost any program to run from disc. Of course it is also the most complex!

The basic ideas are:

- Load the main program down to &1100.
- Load the machine code move routine.
- Set page to &E00.
- Set tape system.
- Call the move routine.
- Old the program.
- Run it.

The effect of this is to move the program down to &E00 (normal Basic memory) and then to run it.

This is the machine code program:

```
10 REM (c) Peter Walker
20 MF=&1100:MT=&E00:AA=&0901:BB=&0904
30 FOR C=0T01:P%=&0900
40 [:OPT C
50 .LOOP LDA MF:STA MT:INC BB: BEQ TT
60 .RT INC AA:BEQ FR:BNE LOOP
70 .TT INC BB+1: BNE RT
80 .FR INC AA+1:LDA AA+1:CMP#&7B:BNE
LOOP:RTS
90 ]:NEXT C
100 *DISC
110 *SAVE"MOVE"0900 0923
120 END
```

This routine will deal with all programs which require moving down memory simply by altering a few variables.

MF = Location the program is to be moved from.

MT = Location the program is to be moved to.

P% = Location of the machine code move routine.

You may have to change these program variables for your own use. For example, if when you transfer the program to disc the OPT command tells you that the program starts at a place in memory below &E00, MT will have to be changed to this new address and the program run again.

In the unlikely case that the start of the program address goes below &900, then the value of P% will have to be changed to something above &7B00, MT changed to the new start of program address, and the program run again.

When you have run this program the machine code will be saved onto the disc under the file name "MOVE". It is also advisable to save the original program.

Once this has been done you are ready to use the program as described. You need a short program to load and run the main program:

```
10 *KEY0 *LOAD"Program_name"1100!M
*LOAD"MOVE" !M PAGE=&E00 !M *TAPE !M
CALL&0900 !M OLD !M RUN !M
20 *FX138,0,128
```

If the program uses \*RUN replace:  
OLD!M RUN!M

with:

```
CALL &DDDD
```

where DDDD is the execution address as shown earlier.

Line 20 puts the value for function key 0 into the keyboard buffer, so you do not have to press it yourself.

Using the method described above I have been able to get about 95 per cent of all my tape programs to run off disc.

Once you have learned to use the method you should have no difficulty in getting them to work.

If you can buy programs on disc do so, because the nominal charge for the disc which most software houses charge is well worth paying, as you also get all the space left on that disc for your own use. You will be surprised just how quickly you can use up all of your available disc space!

# Gemini

# more programs

**STOP PRESS**  
**BBC Payroll Now Available**  
**£39.95**  
 Up to 50 employees per file.  
 No limit on files. **SSP**

**CASH BOOK ACCOUNTS PROGRAM FOR BBC 32K, TORCH, SPECTRUM 48K**  
**NEW . . . . . £59.95**

J. B. SMOCKENT & PART BLACK

\*\*\*\*\*  
 BALANCE SHEET AT 31.12.81

ACCOUNT	DEBIT	CREDIT
1 Bank (2)		4500
2 Equity Shares & GP		2000
3 Purchases (1)	21000	
4 Purchases (2)	17700	
5 Current Stock & GP		5000
6 Sales		700
7 Sales & Wages	4500	
8 Rent & Rates	1200	
9 Heat Light & Power	600	
10 Telephone	450	
11 Insurance	200	
12 Motor Expenses	700	
13 Repairs & Renewals	300	
14 Stationery Expenses	100	
15 Advertising	500	
16 Legal & Professional	100	
17 General Charges	500	
18 Bad Debts Written Off	100	
19 Motor Vehicle (200)	150	
20 Plant/Equipment (200)	150	
21 Leasehold Property (200)	150	
22 Land (200) on Sale of Assets	150	
23 Cash in Hand		500
24 Bank (1)		3400
25 Bank (2)		2000
26 Leasehold Property		2000
27 Leasehold Property Acc Debit		5000
28 Motor Vehicle		4000
29 Motor Vehicle Acc Debit		500
30 Plant & Equipment		2000
31 Plant & Equipment Acc Debit		2000
32 Debtors & Creditors		5000
33 Trade Creditors & Debtors		500
34 H.P. (2)		100
35 V.A.T. Input Tax	1100	
36 V.A.T. Output Tax		600
37 V.A.T. Refunds/Payments	400	
38 Capital A/c (1)		10000
39 Capital A/c (2)		5000
40 Capital Contributions (1)	8000	
41 Drawings (1)	12000	
42 Long Term Loans		4000
43 Bank & GP		5000
TOTALS	174800	174800

J. B. SMOCKENT & PARTS LIMITED BY LTD. (INCORPORATED IN ENGLAND)

One of the most innovative business programs on the market. Replaces a manual cash book system, e.g. Simplex and 'All-in-One'. Written by practising Chartered Accountants, this practical program is simple to use and will replace your manual cash and bank records. By giving you access to vital management information as and when you want it, it will enable you to keep more positive financial control of your business.

The software is extremely well and lucidly documented, and Gemini provide a full technical back-up and product up-date policy. Take a look at the information this program will provide:-

- \* Summary of VAT information for VAT returns
- \* Cumulative receipts and payments report analysed over the standard profit and loss and balance sheet headings
- \* Option for departmental analysis of sales and purchases
- \* Audit trail printout of all transactions.
- \* Journal routine for entering transfers between accounts and year end adjustment for debtors, creditors etc.
- \* Trial balance at any interval
- \* Interfaces to 'Final Accounts' program to produce balance sheet and trading and profit/loss account etc.
- \* Spectrum version may be used with Sinclair OR 80 column printer.

**FINAL ACCOUNTS PROGRAM FOR BBC 32K, TORCH, SPECTRUM 48K . . . . . £59.95**

Requires Cash Book module. This program will take your cash book data to the logical conclusion of balance sheet, trading and profit/loss account and notes to the accounts i.e. fixed assets, land and buildings and capital accounts. Final accounts (BBC version) links to 'Beebplot' for graphic data presentation. Format: Torch disk, BBC disk/cassette, Spectrum cassette.

**Special Offer - Cash Book and Final Accounts together - £95**

J. B. SMOCKENT & PART BLACK

\*\*\*\*\*  
 BALANCE SHEET AT 31.12.81

ACCOUNT	DEBIT	CREDIT
1 Bank (2)		4500
2 Equity Shares & GP		2000
3 Purchases (1)	21000	
4 Purchases (2)	17700	
5 Current Stock & GP		5000
6 Sales		700
7 Sales & Wages	4500	
8 Rent & Rates	1200	
9 Heat Light & Power	600	
10 Telephone	450	
11 Insurance	200	
12 Motor Expenses	700	
13 Repairs & Renewals	300	
14 Stationery Expenses	100	
15 Advertising	500	
16 Legal & Professional	100	
17 General Charges	500	
18 Bad Debts Written Off	100	
19 Motor Vehicle (200)	150	
20 Plant/Equipment (200)	150	
21 Leasehold Property (200)	150	
22 Land (200) on Sale of Assets	150	
23 Cash in Hand		500
24 Bank (1)		3400
25 Bank (2)		2000
26 Leasehold Property		2000
27 Leasehold Property Acc Debit		5000
28 Motor Vehicle		4000
29 Motor Vehicle Acc Debit		500
30 Plant & Equipment		2000
31 Plant & Equipment Acc Debit		2000
32 Debtors & Creditors		5000
33 Trade Creditors & Debtors		500
34 H.P. (2)		100
35 V.A.T. Input Tax	1100	
36 V.A.T. Output Tax		600
37 V.A.T. Refunds/Payments	400	
38 Capital A/c (1)		10000
39 Capital A/c (2)		5000
40 Capital Contributions (1)	8000	
41 Drawings (1)	12000	
42 Long Term Loans		4000
43 Bank & GP		5000
TOTALS	174800	174800

NOTES TO THE ACCOUNTS - 31/12/81

1. FIXED ASSETS

Account	Value	Less Accumulated Depreciation	Net Book Value
Land & Buildings	1000		1000
Plant & Equipment	2000	(500)	1500
Motor Vehicle	1500	(300)	1200
Leasehold Property	2000		2000
<b>Total</b>	<b>5500</b>	<b>(800)</b>	<b>4700</b>

2. LAND AND BUILDINGS

Account	Value
Land	1000
Buildings	0
<b>Total</b>	<b>1000</b>

3. CAPITAL ACCOUNTS

Account	Value
Capital A/c (1)	10000
Capital A/c (2)	5000
Capital Contributions	8000
Drawings	(12000)
<b>Total</b>	<b>11000</b>

**"Gemini's range of software is in the vanguard of the releases for 'serious' micro users..."**  
 (WHICH MICRO AND SOFTWARE REVIEW)

**INVOICES AND STATEMENTS . . . £19.95**  
**Compatible with most micros. See table.** Ideal for the small business. A complete suite of programs together with generated customer file for producing crisp and efficient business invoices and monthly statements on your line printer. All calculations include VAT automatically, and the program allows your own messages on the form produced. This program gives you superb presentation and saves time on one of the most tedious tasks in the office.

**COMMERCIAL ACCOUNTS . . . £19.95**  
**Compatible with most micros. See table.** A gem of a program, all for cassette, with the following features:- Daily Journal. Credit Sales. Cash Sales. Credit Purchases. Purchases - other. Sales Ledger. Purchase Ledger. Bank Account. Year to date summary. A fully interactive program suitable for all businesses. Files can be saved and loaded and totals from one file carried forward to another on cassette. Particularly useful from a cash flow point of view, with an immediate accessibility to totals for debtors and creditors. Bank totally supported with entries for cheque numbers, credits and, of course, running balance.

**MAILING LIST . . . £19.95**  
**Compatible with most micros. See table.** A superb dedicated database to allow for manipulations of names and addresses and other data. Gemini's unique 'searchkey' system gives you a further ten 'user-defined parameters' to make your own selections. Features include the facility to find a name or detail when only part of the detail is known, it will print labels in a variety of user specified formats.

**1 DATABASE . . . £19.95**  
**Compatible with most micros. See table.** The program that everyone needs, the most valuable and versatile in your collection. Facilities include sort search, list print if required. Can be used in place of any card index application; once purchased you can write your own dedicated database to suit your particular needs with a limitless number of entries on separate cassettes.

**STOCK CONTROL . . . £19.95**  
**Compatible with most micros. See table.** Dedicated software with all that's necessary to keep control of stock. This program will take the tedium out of stock control and save time and money. Routines include stock set up, user reference number, minimum stock level, financial summary, line print records, quick stock summary, add stock, delete/change record and more.

**HOME ACCOUNTS . . . £19.95**  
**Compatible with most micros. See table.** Runs a complete home finance package for you with every facility necessary for keeping a track of regular and other expenses, bank account, mortgage, H.P., etc. This program also allows you to plot graphically by Histograms your monthly outgoings.

**AB CD WORD PROCESSOR . . . £19.95**  
**Compatible with most micros. See table.** This program features routines found in much larger and more expensive packages with a typical word length of 5-6 letters it allows for around 1000 words in memory at one time. Ideal for the user who requires a simple program to write letters on his computer. Features include, block delete, block insert, search and replace, edit text, display text and more.

**"Simple to use ....."**  
**"Ideally suited to the way most offices run....."**  
**PERSONAL COMPUTER NEWS**



# Plans for more computers!



## SPREADSHEET ANALYSIS BEEBCALC £19.95 DRAGONCALC £19.95

**NEW**

FOR BBC AND DRAGON 32. Spreadsheet processors have proved to be important tools for using micros in business, scientific and domestic financial applications.

POSITION	A1	RC	SPACE	5185	T	
	II	A	II	B	C	
1	-J.B. SNOOKER T/A POT - BLACK				YEAR	ENDED
2	PROJECTED CASH FLOW				Oct.	Nov.
3				£	£	
4						
5						
6	INCOME					
7	Sales				11786	10944
8						
9	REVENUE EXPENDITURE					
10	Purchases				500	500
11	Advertising				500	1000
12	Director's salary				1596	1596
13	Salaries				2216	2216
14	Rent					
15	Telephone					300
16	Insurance					200
17	Printing, stationary					400
18	Repairs & renewals					
19	Hire of equipment				60	60
20	COMMAND BCDEFGPRSTW*?					

Without any programming knowledge at all, you may:-

- Set up a computerised spreadsheet, with chosen row and column names.
- Specify formulae relating any row or column to any other.
- Enter your source data and have the results calculated.
- Save the results on tape (or disk - BBC) for later reloading and manipulation.
- Print the tabulated results in an elegant report format.
- Experienced users may access saved files and write their own reporting or graphics presentation programs for the results.

Some typical applications:-

- Small business accounting applications, e.g. profit and loss statements and cashflow projections, break-even analyses etc.
- Investment project appraisal - anything from double glazing to oil rigs!
- Comparing rent/lease/buy options.
- Processing the results of scientific experiments or field studies.
- Engineering calculation models.
- In fact, anything that involves repeated re-calculation of results presented in tabular or spreadsheet format.

## Program Availability Chart:-

	Database	Stock Control	Mailist	Invoices & Statements	Spread sheet Analysis	Cashbook Accounting	Word processor	Home Accounts	Commercial Accounts	Plot	Final Accounts
Sinclair Spectrum 16k or 48k	●	●	●			●		●	●	●	●
Dragon 32k or 64k	●	●	●	●	●			●	●	●	
VIC 20 (16k +)	●	●	●	●				●	●		
Sinclair ZX81 (16k +)	●										
Grundy Newbrain	●		●								
Sharp M280A	●	●	●	●				●	●		
Sharp M280K	●	●	●	●				●	●		
Sharp M280B	●	●	●	●				●	●		
BBC Micro model A or B 32k	●	●	●	●	●	●	●	●	●	●	●
Atari 400/800	●										
Torch	●	●	●	●	●	●	●	●	●	●	●
Epson HX-20	●	●	●								
Commodore 64	●		●					●			

## BEEBLOT & SPECTRUMPLOT £19.95 NEW

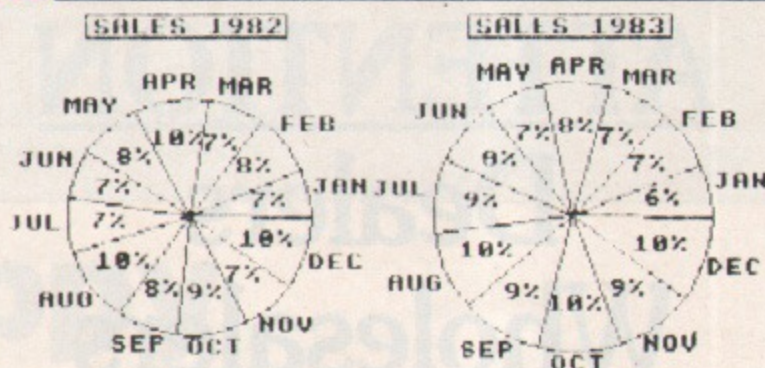

100% = 60055

100% = 70055

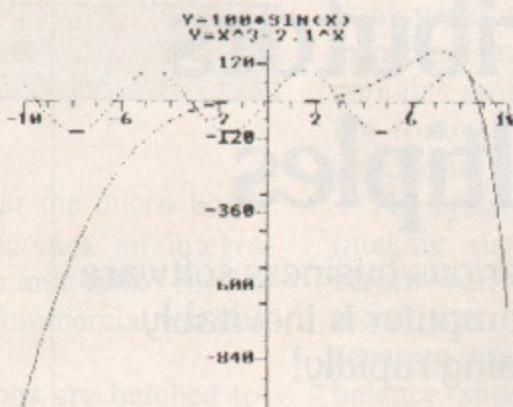

Important new additions to the Gemini family. Present numeric and string data together in easily-understood pie chart, histogram or graph format. Beebplot has a built-in interface to Beebcalc, and both Beebplot and Spectrumplot have built in interfaces to the Final Accounts program of Cashbook. The facility for mathematical function

plotting is also provided. The BBC version has a high resolution screen dump for the Epson or CP-80 printers, and the Spectrum version dumps to the Sinclair printer via the 'copy' key. A very useful program that will give superb results either from direct input of data from the keyboard or via simple access to other software data files. A must for business and education.

Dealer/Trade enquiries invited - generous trade discounts for quantity.

Special ACCESS card instant sales hotline for prompt despatch...  
24 hr Ansaphone Service.  
All enquiries other than credit card sales to 03952-5832

**Tel: 03952  
5165**

Gemini. Functional Software Specialists. 9, Salterton Road, Exmouth, Devon. EX8 2BR

PLEASE SEND URGENTLY

\_\_\_\_\_  
\_\_\_\_\_  
\_\_\_\_\_

(Please note: Items as priced except BBC/TORCH DISKS: please add £4 extra for 40 track and £5 for 80 track format)

Name \_\_\_\_\_

Address \_\_\_\_\_

Machine Type \_\_\_\_\_ Memory Size \_\_\_\_\_

I enclose \_\_\_\_\_

Make cheques and postal orders payable to Gemini Marketing Ltd.

Access Number \_\_\_\_\_

Signature \_\_\_\_\_

"ACCESS ONLY" BY TELEPHONE

# Gemini

MARKETING LIMITED

Gemini. Functional Software Specialists,  
9 Salterton Road, Exmouth, Devon EX8 2BR

# GEMINI

## ATTENTION

Dealers  
Wholesalers  
Distributors  
Multiples

The demand for serious/business software for the microcomputer is inevitably increasing rapidly!

Take a look at our exciting range of quality software. Interested? Then talk to us about our advantageous terms and ask for our dealer pack, or a visit by one of our qualified sales staff.

For a full description of our product range see previous two pages.

## ACT NOW!

FULL DEALER  
LIST NEXT MONTH.

# GEMINI

MARKETING LIMITED

Functional Software Specialists,

9 Salterton Road Exmouth Devon  
EX8 2BR Tel: 03952 5832

## THE BBC MICRO SOUND SYSTEM MICROVOC

As supplied to Schools & Colleges

### SYSTEM INCLUDES:

Speakers, Volume control, jack sockets and all connections (assembled).

Easily fitted with no drilling, soldering or cabinet modifications **£23.00** inc VAT and p & p

**MUSIC SOFTWARE** now available.

Royalties paid for Musical and Educational Software.

### MICRO-ADVENT

Ashlyn House, 113 Writtle Road, Chelmsford, Essex.

Tel: 0245 59708



"Always Something New"

## KUDUSOFT

SOFTWARE FOR THE BBC MICRO

**STAR PATROL:** Multi-stage Space War. Differing situations. Enjoy the thrills - test your skills, flying your Spacecraft against the enemy. Full Colour and Sound effects.

For Model B: **£6.50** incl. p&p.

**STARBATTLE:** Destroy the Alien Starships before they get through to you. Avoid the onrushing meteorites. Increasing Skill Levels. Full Colour & Sound effects.

For Model B: **£5.50** incl. p&p.

**STARLANDER:** Full use of MODEL A. Test your skills in landing your Starship under increasingly difficult conditions. Full Colour and Sound.

**£3.50** incl. p&p

**KUDUSOFT, 130 Main Street, Tweedmouth, Berwick-upon-Tweed. TD15 2AW.**

## MUSICSOFT

Fun & Educational Software for BBC 32K

**'PIEMAN'** ... Not as Simple as Simon!

Starting with a Simon look-alike, this suite of musical games is great fun for 5 year olds, yet proves frustrating and addictive to music graduates in the later stages. Scores and skill levels are additive and alterable. **'PIEMAN'** cassette and instructions **£3.75** inc. P&P

**'MUSICTOOLS 1'** ... Over 60 procedures to use in your own musical programs, already incorporated in the following 5 working programs to illustrate their use: ● **ORGAN.** Play, store, replay faster, slower, exactly as played(!) or smoothed out, 6 or 7 octaves with notes not mentioned in the guide. ● **TUNE GENERATOR.** Creates a chord sequence, tune, quaver variations, displays a dynamic keyboard and notes on a staff as tune is played (it LOOKS like music). ● **CLEFTOOL.** Draws musical symbols in 26 different sizes on a staff, this one is great for teachers. ● **1, 2, 3 PART TUNE PLAYER.** Simple input from data, with demo tune. ● **ENVELOPE EXPLORER.** Display and alter all parameters with cursors. Experiment with the sound power of the B.B.C. Micro.

**'MUSICTOOLS 1'** cassette and instructions **£5.75** inc. P&P.

Sounds great with Microvoc - see full page ad this issue.

Cheques & Official orders to:

**'MUSICSOFT' 12 Fallowfield, Ampthill, Beds. 0525 402 701**

## BBC MICRO CONSOLES

Not just a monitor/tv stand but an expansion console which gives your micro the professional look. Protects and encloses your micro with room for disc drives and 2nd. processor or teletext adapter etc., all untidy connecting wires safely out of sight within the console. Made of light yet strong aluminium with a textured finish in matching BBC colour. Coming soon a bolt on extra module to the console for further expansion options. YES this console will grow with your needs. Basic BBC console as shown **£39.99** + £4 carriage MAIL ORDER ONLY. Viewing by appointment only.

For further information or send cheque to **£43.99** incl. post/pack to:

**Silent**  
COMPUTERS

Matching Printer Stand, can double for VDU Stand over the micro - only **£14.99** + £2 carriage  
27 WYCOMBE ROAD, LONDON N17 9XN.  
TEL: 01-801 3014 (24 Hr Ansaphone)

Please add 15% VAT.



• The console will house the Torch Disc Pack

# Cashbook package can keep your bank manager happy

**CASHBOOK** from Gemini is a comprehensive and adequate accounting system. It will enable business people with a moderate grasp of accounting principles to produce a set of figures that will satisfy both the bank manager and the tax man.

More important, it will give a confident grasp of the business's finances and profitability.

Cashbook offers no fewer than 80 predefined accounting codes covering all matters a conventional business is likely to encounter. Receipts can be analysed into 12 classifications and any single payment can be split into

## Cashbook (Gemini)

five. This means that the micro book-keeping activity becomes an integral part of the "cash-up and bank" routine at the end of each commercial working day.

Just as transactions are batched together and a batch record printed (to match the paying-in or cheque counterfoil if desired), so there is no need for separate pen and paper records.

The journal (of cumulative transac-

### BALANCE SHEET AT 31/12/82

	1982 £	1981 £
Fixed Assets	50500	30950
Goodwill	2000	2000
	<hr/> 52500	<hr/> 32950
<b>CURRENT ASSETS:</b>		
Stock & WIP	5000	3000
Debtors & Prepayments	2000	4000
Cash in Hand	500	200
VAT recoverable	500	
	<hr/> 8000	<hr/> 7200
<b>LESS CURRENT LIABILITIES:</b>		
Trade Creditors & Accruals	9300	3300
H.P.	800	1000

## Arcadians (Acornsoft)

THIS colourful shoot-them-out-of-the-skies game, can be played with either keyboard or joysticks.

There aren't any bases for you to hide behind, so your only hope of survival is to get out there and attack.

There are four different kinds of Arcadians and none of them want to make friends. If you can hit them when they're flying down you get bonus points, and once you've cleared the first screenful they all come back again.

The speed of attack and the number of Arcadians in flight at any time increases as you get further into the game.

The keyboard controls actually seem better than the joystick, and with just a little practice you should easily be able to murder several screenfuls of Arcadians before your three chances

## Action in Arcadia

are up. A nice feature is the one or two player option, and the sound effects are also good.

If you get to 7,000 points you are awarded an extra laser base, and no doubt addicted Invaders addicts will be up until the early hours with this game, reaching high levels of skill and ingenuity.

Perhaps for the rest of us though, it lacks the sophistication which the BBC Micro really deserves – not through any fault of design, just because it's all been done before, and probably better.

Jane Jackson

tions under any account code) can be inspected on demand, and the system contains an impressive array of checking routines. Cash and bank balance checks are available as required.

The system proceeds to trial balance (making sure all the figures add up before worrying about how to present them) and, after final adjustment, a separate program is used to produce a balance sheet and a profit and loss account. There is the customary provision for printing the results of a previous year alongside for comparison.

It must be stressed that this program is designed for an average, conventional business. Anyone running a nudist colony or a crocodile farm might find that although everything needed is provided (at least so far as accounts are concerned!), so are many redundant codes that take an irritating time to skip over.

For example, young mothers running a nursery school would legitimately jib at "wife's wages" as well as the countless codes for motor vehicles and "plant". It might have been better to set the major categories of codes (income, running costs, depreciation, etc) and left the detailed codes for the user to define.

This would have avoided incongruities such as allocating only four analysis codes to sales while allocating an equal number for invested capital. A dozen user-definable codes at the end would have provided for the quirks of individual businesses.

I also feel that too little help is given to the user who has no accounting

## From Page 35

background. The guide tries to help but it takes many months to digest such accounting jargon as "accruals", "assets" or "WIP".

The program, too, is a little curt, and could do more to comfort the novice. When you want to know where to enter the £500 loaned you by Auntie Maud, to be confronted with "Capital Intro (1)" is a little frightening.

It would also be useful if the program gave a friendly nudge each time the user is confronted with "Debit (D) or Credit (C)". That may be adequate for payments into a bank account but how about offsetting the depreciation on a crashed, middle-aged Cortina with a payment for half a new one from an insurance settlement?

Many small business advisers encourage clients to abandon double entry bookkeeping altogether, but Gemini have probably been wise to stick to conventions at this early stage in the development of Micro usage.

It would be unfair to expect one floppy disc-full of program to provide a full training in accountancy, and these comments must not obscure the fundamental value of the package.

The average small entrepreneur with no more than a couple of employees (or wives!) expects to pay between £200 and £500 in accountant's fees each year as well as doing the bookkeeping.

At £95 all in, this program will help save time and errors in the bookkeeping and then avert the final accountant's costs, provided that the user masters it thoroughly. However, let no one overlook the valuable guidance in tax matters that may be lost if the accountant is paid off.

Those with no business accounting or bookkeeping experience should acquire some before buying this program.

All potential users, especially busy ones, should allow a couple of months tryout time before starting serious use, and should run their accounts manually in parallel for a full financial year before trusting the Cashbook system on its own.

Gemini's program will work fine but don't forget the gremlin called "human error".

John Vogler

## Bakery bun fight

*ONCE upon a time, in the long ago days when I was a student, I used to work in a bakery as a summer job. I found it was both great fun and hard work. The same goes for Squirrel Software's Bun Fun.*

*The idea is that you are a worker in a bun factory. Cakes pass in front of you on a conveyor belt and it's your job to put on the icing.*

*Your mate further along the belt puts on the walnuts and you get paid piecework.*

*The more perfect cakes you make the more you earn. The more you waste the less you take home.*

*Sadly, your mate has just cleared off to do some fishing and you're left to do both the icing and the walnuts. Oh yes, and you mustn't make too much mess*

### Bun Fun (Squirrel)

*or the machine will jam!*

*With five levels of difficulty and five choices of how long you want to play, Bun Fun is fast and furious.*

*Strictly for those not of a nervous disposition, it's a game calling for fast reactions – the kind of game where an 11-year-old will beat his or her parents every time.*

*Easy to learn, well explained and fun to play, it's a game that will drive you mad ... but you won't mind.*

*However there is one drawback – unlike my time at the bakery, you can't eat the end products.*

Nigel Peters

## Space Invaders...plus

ALIEN Destroyers is a Space Invaders type game with novel additional features.

It is for keyboard play only, but you can choose which keys you use to move left, right and fire, making it easier for you to settle into a championship position and reach high scores.

You have three bases, and more can be earned as you reach higher scores. The first screen of invaders appears against a vivid blue background and this alternates with a more restful black sky, but there is no escape from the menacing bombs in either game.

You can hide behind the defences while they last, but your only real hope lies in attack.

One of the nice things about this version is the amount of choice there is in choosing a level of skill at which to play.

You can set the alien speed at any of six levels, the bomb speed at three, (fast, very fast and very, very fast), choose whether to have the aliens advancing or not, (why be foolhardy!),

### Alien Destroyers (Program Power)

whether to have vertical bombs only or risk the multidirectional shrapnel, and whether to have a fast base or not.

All this makes it a much more versatile game than a Space Invaders version might have been.

Also, after each game you get a full battle report – which tells you how many of each alien you destroyed, how many screenfuls you eliminated, how many torpedoes were fired and the percentage of these which hit one of the aliens, how many of your bases were hit, what your final score was and at what level you were playing.

The game also has an invaluable pause button, useful when things just get too much!

Altogether this is a fun, colourful game which, despite only having keyboard controls, has a lot of good points to recommend it.

Linda Case

# Midwich

COMPUTER COMPANY LIMITED

1st choice for **BBC** microcomputers

## BBC COMPUTERS

Model B £346.95  
 Model B + Disc Interface £441.95  
 Please phone to check delivery  
 (Credit cards are not accepted in payment for BBC Micros)

## BBC COMPATIBLE DISC DRIVES

Cased drives, finished to match the BBC Micro are supplied complete with connecting cables, manual and utilities disc. All single cased drives may be expanded to dual configuration by the addition of the appropriate uncased mechanism.

Disc Capacity	Single	Dual	Uncased
100K	£195.00	£335.00	£142.00
200K	£235.00	£449.00	£216.00
400K	£290.00	£545.00	£260.00

Trade/Quantity discounts are available.

## PRINTERS

NEC 8023 Printer £320.00  
 (Carriage £10)

# NEW

Shugart Single 100K Disc Drive  
 (Fully compatible with BBC Micro)  
 £199 + VAT  
 Carriage £5 + VAT

Utilities Disc with Word Processor  
 £25 + VAT

Supplied complete with all Connecting Cables

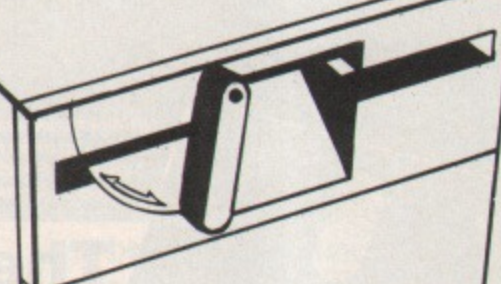

Expansion slot for second Drive  
 £140 + VAT

# Fast ex-stock delivery by Securicor...

All prices exclude VAT.

## BBC UPGRADE KITS

BBCA2B Complete A to B Upgrade £44.75  
 BBC 1 16K Memory £18.00  
 BBC 2 Printer/User I/O Kit £ 7.50  
 BBC 3 Disc Interface Kit £95.00  
 only supplied with Disc Drives  
 BBC 4 Analogue Input Kit £ 6.70  
 BBC 5 Serial I/O RGB Kit £ 7.30  
 BBC 6 Bus Expansion Kit £ 6.45

All kits are supplied with full fitting instructions.

## BBC CONNECTORS

BBC 21 Printer Cable and Amphenol Plug (not assembled) £ 7.50  
 BBC 22 User Port Connector and Cable 36" £ 2.46  
 BBC 23 Cassette Lead £ 3.50  
 BBC 24 7 Pin Din Plug £ 0.60  
 BBC 25 6 Pin Din Plug £ 0.60  
 BBC 26 5 Pin Din Plug £ 0.60  
 BBC 35 Disc I/O Cable 34W IDC to 2 x 34 way Card Edge £12.00  
 BBC 36 Disc Power Cable £ 6.00  
 BBC 44 Analogue Input Plug & Lever £ 2.25  
 BBC 66 1 M Bus Connector + 36" Cable £ 3.50

## BBC ACCESSORIES

BBC 45 Joysticks (per pair) £11.30

## ACORN SOFTWARE FOR THE BBC

SBE03 Business Games £ 8.65  
 SBE04 Tree of Knowledge £ 8.65  
 SBE02 Peeko Computer Inc Manual £ 8.65  
 SBE01 Algebraic Manipulation PK £ 8.65  
 SBX01 Creative Graphics Cassette £ 8.65  
 SBX02 Graphs & Charts Cassette £ 8.65  
 SBB01 Desk Diary Inc Manual £ 8.65  
 SBL02 Lisp Cassette £14.65  
 SBL01 Forth Cassette £14.65  
 SBG01 Philosophers Quest £ 8.65  
 SBG07 Sphinx Adventure £ 8.65  
 SBG03 Monsters £ 8.65  
 SBG04 Snapper £ 8.65  
 SBG15 Planetoid £ 8.65  
 SBG06 Arcade Action £10.35  
 SBG05 Rocket Raid £ 8.65  
 SBG13 Meteors £ 8.65  
 SBG14 Arcadians £ 8.65  
 SBG10 Chess £ 8.65

## ACORN SOFTWARE BOOKS FOR THE BBC MICRO

SBD01 Creative Graphics £ 7.50  
 SBD02 Graphs - Charts £ 7.50  
 SBD04 Lisp £ 7.50  
 SBD03 Forth £ 7.50

\* Please ring for current delivery on Acornsoft products before ordering.

## BBC MICRO COMPONENTS

4516 100NS £ 2.25  
 6522 £ 3.19  
 74LS244 £ 0.59  
 74LS245 £ 0.69  
 74LS163 £ 0.34  
 DS3691N £ 4.50  
 DS88LS120N £4.65  
 UPD7002 £ 4.50  
 8271 £36.00  
 20 Way Header £ 1.46  
 26 Way Header £ 1.76  
 34 Way Header £ 2.06  
 40 Way Header £ 2.32  
 15 Way D Skt £ 2.15  
 6 Way Din Skt £ 0.90  
 5 Way Din Skt £ 0.90

## BBC SOFTWARE IN ROM.

Wordprocessor "View" £52.00  
 1.2 MOS £10.00

12 month "no quibble" warranty on all products

Fitting Service available



# ...from East Anglias leading supplier

Delivery charges  
 Computers/Disc Drives £7.50  
 Components/Software £0.50  
 Books/Joysticks £1.00

MIDWICH COMPUTER COMPANY LIMITED

RICKINGHALL HOUSE, RICKINGHALL, SUFFOLK IP22 1HH  
 TELEPHONE (0379) DISS 898751

# AMS announce the 3" disk drive

Simply plug in—ready to run



- \* Format and verify utilities on disk or EPROM
- \* Interface cables
- \* Manual
- \* Free disks

- \* 100k—£225
- \* 200k—£399

includes VAT and delivery to your door

*NB When used with some computers, both drives and disks have a double density capability. Educational and Institutional orders welcomed.*



**The neatest and best disk option ever**  
We've taken the brilliantly engineered and proven Hitachi 3" drive and housed it in rigid steel, textured and coloured to match your BBC Micro. And we've added cables, manuals, utilities on disk and EPROM, free disks—everything you need to upgrade your machine.

Japan, home of the major disk drive manufacturers, has decided to make the new 3" disks a standard. And no wonder. Not only are they strong and easily stored, they give 100K per side, and you simply flip them over in the same way as a music cassette. The small light on the casing reminds you which side you are using. The disk is totally encased in rigid plastic, with no exposed surfaces, is easily inserted with one hand and simply removed by pressing the eject button. A unique feature of the new disks is a mechanical tab which prevents overwriting of precious data. And of course, you can switch it back when necessary.

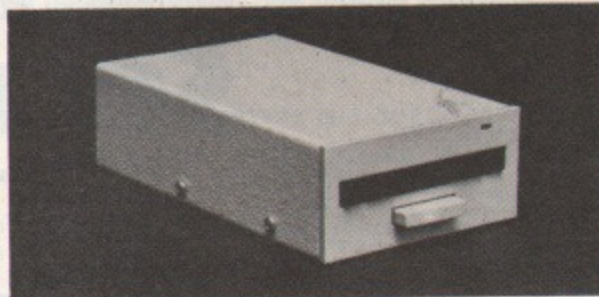

### Reliable and Robust

The Hitachi drive boasts a brushless direct drive motor, the best possible system for trouble-free use. AMS-3 units simply run off the BBC power supply—they don't need their own supply and there's no need to worry about corrupt data.

The standard interface lets you use the disk drive with most other computers and in tandem with 5¼" drives.

### High Speed Access

The disk drive provides a track-to-track access time of only 3mS, much faster than old-fashioned drives.

### Reliable delivery

You can now order your AMS-3 by mail order direct from Advanced Memory Systems Ltd. The units are delivered by courier service, complete with everything you need to get started. Just plug in the cables, and away you go.

Fill in the coupon below and we will send it to you with our full no-quibble money-back guarantee. Advanced Memory Systems Ltd, Woodside Technology Centre, Green Lane, Appleton, Warrington, Cheshire WA4 5NG.

\*Disk drives supplied by Hitachi Europe Ltd. RING (0925) 62907. 24-HOURS.

TO: Advanced Memory Systems, Ltd, Woodside Technology Centre, Green Lane, Appleton, Warrington, Cheshire WA4 5NG.

Please send me by door-to-door courier:

\_\_\_\_\_ (qty) AMS-3 (S) single disk drive at £225 each with free disk.

\_\_\_\_\_ (qty) AMS-3 (T) twin disk drives at £399 each with two free disks.

(Prices include EPROM, utility disk, cables, manual, VAT and delivery).

Please send me by post, if not with drives:

\_\_\_\_\_ (qty) double sided (100K x 2) disks at £4.95 each.

\_\_\_\_\_ (qty) packs of five at £22.50 per pack.

\_\_\_\_\_ (qty) utility EPROM at £15.

I enclose a cheque for £ \_\_\_\_\_

Name \_\_\_\_\_

Address \_\_\_\_\_

Post Code \_\_\_\_\_ Tel No \_\_\_\_\_

Signature \_\_\_\_\_

Please allow up to 28 days for delivery.

BM/8

# WHY

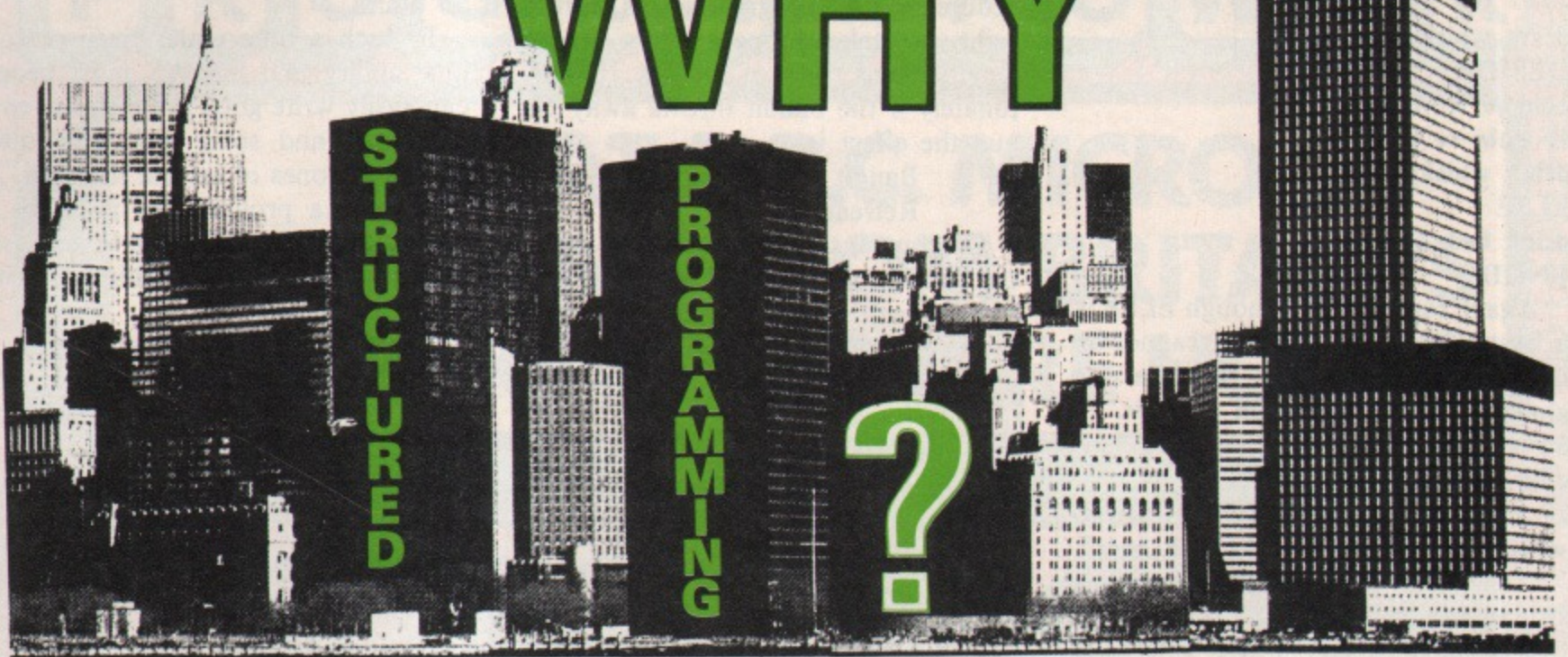

*"And always moving as the restless spheres." Tamburlaine the Great – Christopher Marlowe, 1587.*

ONE of the first electronic calculators to appear on the UK market was called Anita. It cost about £900 at 1965 prices and it was very heavy, though described as portable.

In those days the difference between a calculator and a computer was simple. Anita could do computations but it could not store a sequence of instructions. It was definitely a calculator. A computer, on the other hand, could store a set of instructions and whizz through them without human interference.

Sometimes the intermediate results in a computing process determine which of two or more courses of action should be taken. Decisions like this are the third major task in program control, the other two being repetition and the organisation of procedures.

A decision, or selection, between two or more processes in a program implies that the programmer has extra work to do so that all possible courses of action are defined along with the criteria for choosing them.

The justification for this extra work is that it keeps things moving.

Without it a task would require several or many programs instead of one and would take very much longer to complete.

Just as the right loop structures enable a programmer to magnify his effort in a controlled way and procedures help him or her to deal with complexity, so the right structures help to keep clear the different possible paths through a program.

**CONCEPT: Simple binary decision**

Simulate the deputy sheriff's decision

## Take the right line to keep things moving

By **ROY  
ATHERTON**

to reload when his gun is empty.

We have already seen the programming of this example which was slipped into an earlier program without much discussion. Discussion is necessary however and we should start with an appropriate design.

**DESIGN**

**IF shots = 6 THEN**

**reload**

**ENDIF**

This design follows the usual pattern of having opening and closing keywords and content lying between them. If we weaken this concept by allowing exceptions then we should be aware of what we are doing, and in particular we should keep the full structure as our starting point, soon to be expanded into essential generalisations.

Unfortunately the word ENDIF is

not available in BBC Basic so the program code is different in detail and layout.

**SYNTAX**

**IF shots = 6 THEN PROCre\_load**

It is worth noting that the use of a procedure could be avoided here because the content of the structure can be several statements separated by colons.

**SYNTAX**

**IF shots = 6 THEN PRINT "Eject used cartridges": PRINT "Load new bullets"**

Such extensions should be used with discretion because the layout is unhelpful. Imagine, for example, the effect of putting a loop within the content of such an extension.

Comal, in common with many other languages, allows some "short structures" but limits their use to those whose content is a single statement. In Comal one would have to write:

**IF shots = 6 THEN**

**PRINT "Eject new cartridges"**

**PRINT "Load new bullets"**

**ENDIF**

This should be regarded as the correct, full or global concept in which there are no artificial constraints on what can lie between IF and ENDIF. When working on the program design this should be used. The translation into BBC Basic may be best done with a procedure as already suggested.

**CONCEPT: General binary decision**

There is a more general type of binary decision than just action or no action – the one which Hamlet found so difficult. There is the choice between two different positive alternatives.

Simulate a saloon bar customer tossing a coin to decide whether he should

## From Page 39

drink whisky or beer.

### DESIGN

```
coin = RND(2)
```

```
IF coin = 1 THEN
```

```
  drink whisky
```

```
ELSE
```

```
  drink beer
```

```
ENDIF
```

Again, regrettably, although ELSE is a keyword of BBC Basic it cannot be used on a separate line to close one global structure and open another.

### SYNTAX

```
coin = RND(2)
```

```
IF coin = 1 THEN PRINT "Drink whisky" ELSE PRINT "Drink beer"
```

If the content of each part of this structure is anything more than one or two statements, clarity and control is best preserved by embodying each segment in a procedure.

```
IF coin = 1 THEN PROCwhisky ELSE PROCbeer
```

```
-  
-  
-  
-  
-
```

```
DEF PROCwhisky
```

```
-  
-  
-
```

```
ENDPROC
```

```
DEF PROCbeer
```

```
-  
-
```

```
ENDPROC
```

We need to be careful not to misuse decisions. The combination of binary decisions and GOTO statements could replace all the structures except procedures, but that does not mean that they should.

Let us return to a simple solution to the problem of the deputy sheriff and the bandit, with the added complication that if the deputy runs out of ammunition he must retreat.

We might be tempted to use a GOTO statement. Suppose he starts with ammo of 30 bullets.

```
10 shots=0:ammo=30  
20 REPEAT  
30  gunout=RND(20)  
40  PRINT "Fire a shot"  
50  shots=shots+1:ammo=ammo-1  
60  IF ammo=0 THEN GOTO 100  
70  IF shots=6 THEN PROCre_load  
80  UNTIL gunout=20  
90  PRINT "Bandit throws out gun"  
100 REM Out of ammo  
110 PRINT "Retreat quickly"  
120 END
```

We assume a sensible reload procedure, and the program seems, at first sight, to take proper action if the deputy runs out of bullets. Unfortunately if the bandit throws away his gun the effect is:

Bandit throws out gun

Retreat quickly

Of course, the deputy should arrest the bandit so we "patch" the program.

```
60 IF ammo=0 THEN GOTO 120  
70 IF shots=6 THEN PROCre_load  
80 UNTIL gunout=20  
90 PRINT "Bandit throws out gun"  
100 PRINT "Arrest bandit"  
110 GOTO 140  
120 REM Out of ammo  
130 PRINT "Retreat quickly"  
140 END
```

This is a familiar situation — one GOTO has led to another. It looks innocent enough but the fundamental rules about structure are broken, and some of the worst programs written started in seemingly innocent ways.

Instead we can remember that, with the exception of a few tricky situations discussed in learned journals, the vast majority of problems can be solved with the standard structures.

The questions to ask are: "Which concept applies?" and, knowing that we have a case of repetition, "What are the conditions for ending the loop?"

The answer is that the loop may end either because the bandit surrenders or because the deputy runs out of ammunition. Let the program design reflect that fact.

### DESIGN

#### REPEAT

Fire a shot

IF gun is empty THEN reload

UNTIL bandit surrenders OR deputy out of ammo

This terminates the loop properly, but we do not know which of the two possibilities is the cause. So we decide using a standard structure.

IF out of ammo THEN

Retreat quickly

ELSE

Arrest bandit

ENDIF

Thus we keep proper control, and we know that however complex our problem may be it is unlikely that such methods will fail.

More important, the ideas and techniques merge into the powerful blend of problem solving and program design skills.

It is known that beginners (not whizz-kids) can acquire the essentials of good program control in a few

months or in a formal course of 40 or 50 hours.

In such a time scale, given reasonable ability and interest, most people can easily write good programs of over fifty lines and some will write quite impressive ones of several hundred. At that stage a programmer is ready to reconsider the approach to larger tasks and to polish his techniques using structured design.

The final version of the program is given below. It illustrates a powerful range of concepts: repetition, decisions, procedures, parameters.

```
shots=6:ammo=30  
REPEAT  
  gunout=RND(20)  
  PRINT "Fire a shot"  
  shots=shots+1:ammo=ammo-1  
  IF shots=6 THEN  
    number=RND(6):PROCre_load(number)  
  UNTIL gunout=20 OR ammo=0  
  IF ammo=0 THEN PRINT "Retreat quickly" ELSE PRINT "Arrest Bandit"  
END  
DEFPROCre_load(number)  
  FOR shell=1 TO number  
    PRINT "Eject used cartridge"  
    PRINT "Insert shell"  
  NEXT shell
```

There are just four main structures used in this program: REPEAT / UNTIL, FOR / NEXT, IF / THEN / ELSE and DEFPROC / ENDPROC.

Other vital concepts are also present — meaningful names of variables and procedures, and the use of parameters.

There are also the writer's own self-imposed rules about indentation and the use of lower case. The use of a compound condition using OR should be noted.

The use of lower case for variable names, etc. helps readability by contrasting with the upper case keywords. The latter then stand out and help in finding the way around a program, like pubs at street corners help navigation around a city.

This rule also sidesteps some awkward errors which may arise if upper case variable names incorporate, or are the same as, keywords.

These are the essential concepts of program control in BBC Basic and also of sensible problem analysis and program design.

By modern standards they are slightly defective, but, as demonstrated in "Structured Programming with BBC Basic" (Heinemann Education, 1982), with a little care they can support structured programming.

● To be continued





# MAKE A SPLASH!

## .. and WIN a PL Graphics Digitiser

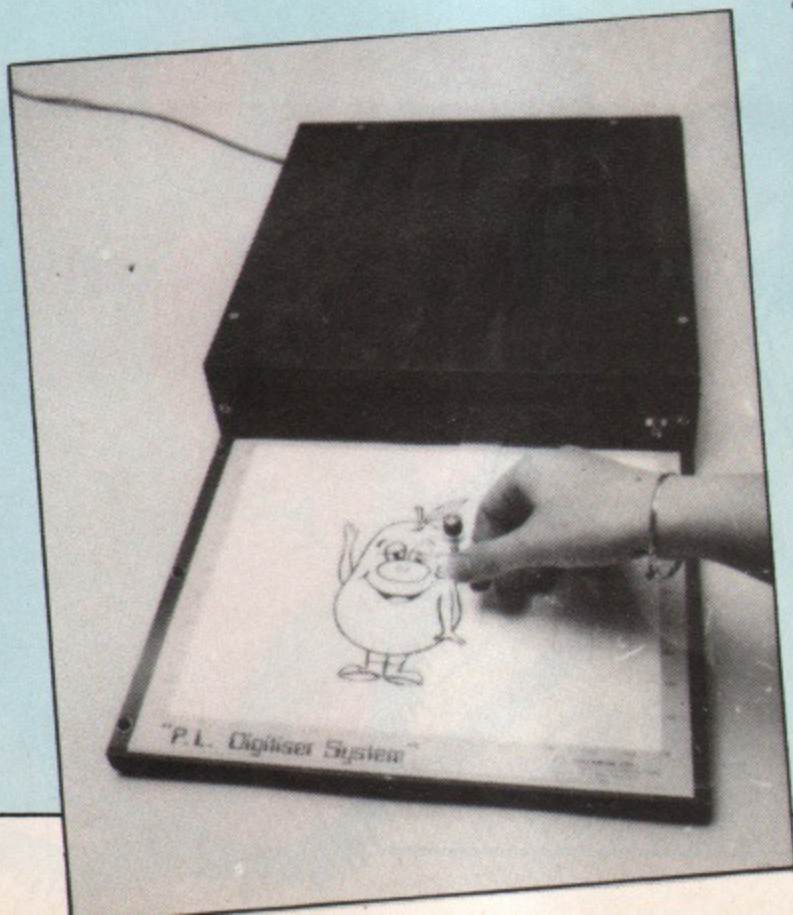

THE prize in this month's *Micro User* competition is a complete graphics system, consisting of a PL Digitiser – as reviewed in last month's issue – together with its powerful new graphics software.

The package enables the user to exploit the full potential of BBC Micro graphics. Included are such advanced facilities as painting areas, rotation, animation, mirroring and improved image justification. This means that whatever you can visualise you can draw without having to master the intricacies of the BBC Micro's graphics commands.

Your task is to produce a "diving board" program in which your high-diver climbs some steps (not necessarily a ladder), walks to the edge of a diving board and plunges into a swimming pool.

Of course you can add whatever effects you want. There should be considerable scope for creativity in, for example, making the board bounce up and down, or adding a splash as our intrepid aquanaut hits the water.

We'll be looking for the program that combines realism on one hand with the most creative use of the BBC Micro's graphic and sound capabilities.

If you haven't read Paul Leman's excellent article on animation on Page 16 do it now. It will prove invaluable in helping you with your entry.

Complete the coupon on this page and send it together with the listing and program on either cassette or disc to the address given.

Your cassette will be returned provided you enclose a stamped addressed envelope. Otherwise it will be donated to a school.

If you don't want to cut your copy of *Micro User* you can send a photocopy of the coupon. Closing date for entries is August 31.

### Your FREE entry form

My cassette/disc and listing for the BBC digitiser contest is enclosed.

Name \_\_\_\_\_

Address \_\_\_\_\_

Tel. No. \_\_\_\_\_

POST TO: Digitiser Contest, *Micro User*, Europa House,  
68 Chester Road, Hazel Grove, Stockport SK7 5NY.

# INSIDE

# KING KONG

I DON'T often copy programs from magazines, but the game of King Kong, which was featured in *The Micro User* in April, looked so appealing that I decided to devote a few hours to it. I wasn't disappointed — it's quite an enjoyable game — but I found myself becoming increasingly frustrated at some of the features of the programming style.

I admit to being a purist, and to liking good programming for its own sake, but that doesn't mean that good programming is solely for the purists. It can help us all to write more easily, more confidently, and with better use of available memory.

I should point out that King Kong is, in fact, well on the way to being well structured. If it weren't, I wouldn't even have considered trying to copy it.

I know that I can't copy a program without making mistakes (can anyone?). I know that it will be much easier for me to find and correct the mistakes if I understand the program, and a well-structured program is just so much easier to understand than one which is (or appears to be) cobbled together.

This critique of the program is thus along the lines of "Here's how a fairly well structured program might have been improved", rather than "What an atrocious program".

First, of course, there were the actual listing errors: lines 180 and 450 were somehow corrupted before the listing was made. Line 450 wasn't too hard to reconstruct, but a lot of thought had to go into line 180. (See corrections in May issue — Editor.)

I know how painful it is to read one's own programs looking for such errors, but it really should be done with programs intended for publication.

And now for the general critique,

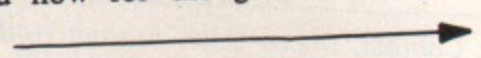

**Simon says style is all**

# ***A case study in structured programming***

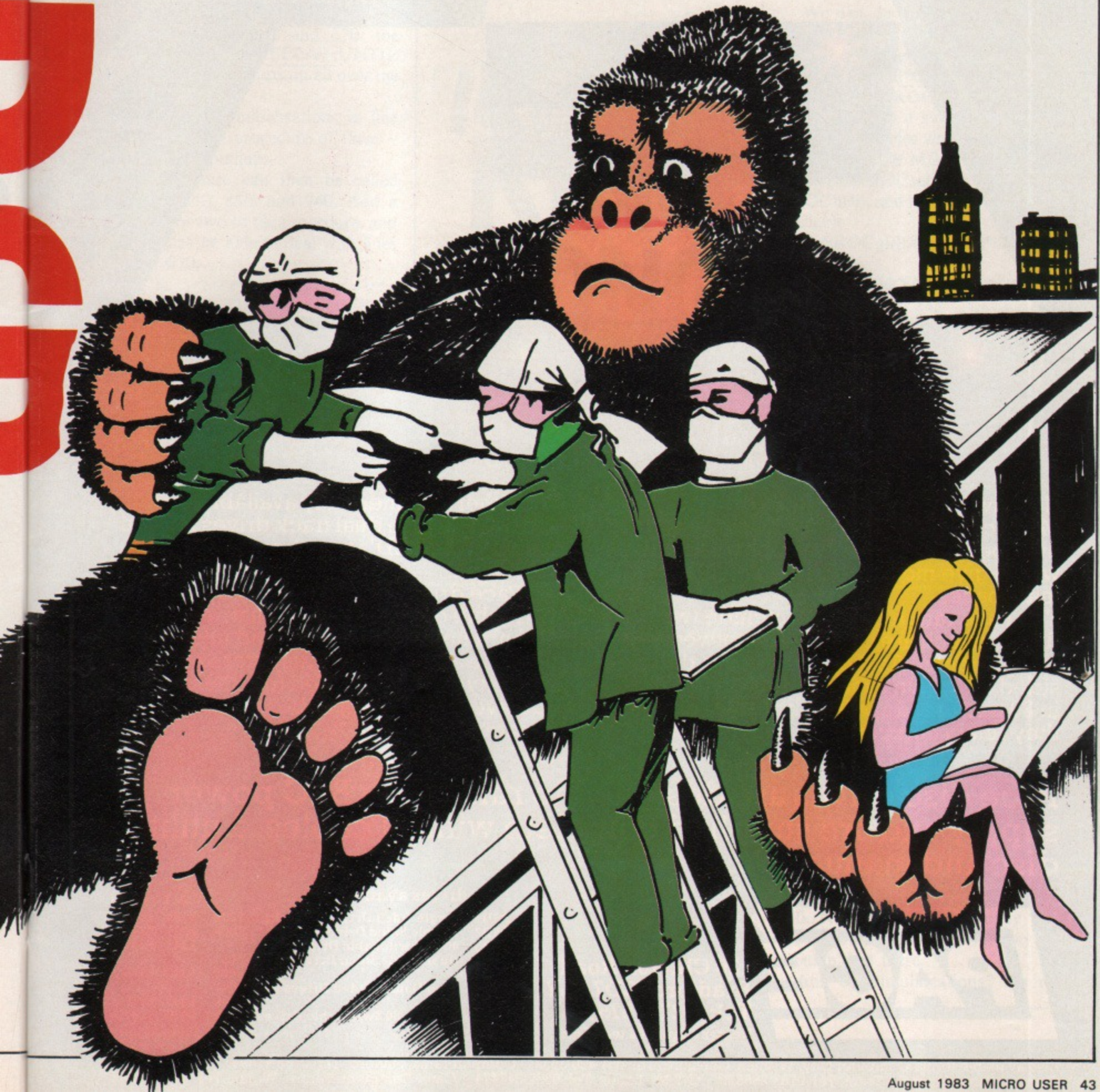

# BYTE YEARS AHEAD!



Now available for the BBC Microcomputer, this superb range of high performance, low profile disc drives which give more data storage, and use less space.

The Pace range of drives include two drives which are switchable between 40 and 80 tracks. As these drives are double sided they give a massive 400 k per drive in 80 track mode, whilst in 40 track mode they retain compatibility with Acornsoft

and other commercially available software. These dual track drives feature multi-colour LED's to indicate mode selection.

All Pace drives are capable of being used as double density drive so that, as and when, a new filing system and interface become available, the disc storage capacity will be doubled (eg. the dual 40/80 drive will have an unbelievable 1.6m of storage).

Pace disc drives are designed to run off the BBC power supply and are supplied complete with all cables, a utilities disc and manual.

# PACE

130 Clayton Road,  
Bradford, BD7 2LY,  
Tel: (0274) 575973  
Dealer enquiries welcome

#### Disc drives available:-

			ex. V.A.T.	inc. V.A.T.
PSD1	Single Sided Drive (40 track)	100k	£185	£212.75
PSD2	Double Sided Drive (40 track)	200k	£235	£270.25
PSD3	40/80 Switchable Drive 400k		£345	£396.75
PDD1	Dual Single Sided Drives (40 track)	200k	£338	£388.70
PDD2	Dual Double Sided Drives (40 track)	400k	£449	£516.35
PDD3	Dual 40/80 Switchable Drives	800k	£610	£701.50

"Carriage and insurance charge of £4.50 inc. V.A.T. to be added per drive"

Also available from:- Computer City, Widnes, Cheshire. Tel: 051-420-3333. Computerama, Stafford. Tel: 0785-41899.  
Computerama, Stoke on Trent. Tel: 0782-268620. G.T.M., Leeds. Tel: 0532-647474. Catel Computer Centre, Wigan. Tel: 0942-44382.

## From Page 42

split into sections for the sake of clarity.

The program fits into Mode 1, but there isn't a lot to spare. A slightly more ambitious game, or the same game with a few more frills, would have to make do with the two colours offered by Mode 4.

Yet a startling amount of space is wasted by the duplication of significant chunks of code. PROCcheck repeats the same sequence of statements for four different conditions. A dozen or so variables are initialised identically in lines 240, 850, and 940, and with slight variations in lines 580 and 670; the sequence TIME=0: REPEAT UNTIL TIME > something crops up all over the place: and so on.

Let's take the initialisations in line 240 and make a procedure of them - PROCrestart, perhaps.

The procedure can then be called from lines 240, 850, and 940. Add a parameter or two to the procedure, and it would also be able to deal with lines 580 and 670.

Let's write a procedure PROCwait(n): TIME=0: REPEAT UNTIL TIME > 100\*n: ENDPROC. Now every delay loop can be replaced with PROCwait(number), where number is the number of seconds in the delay. We can even replace the for-loop delay in line 550 (which must have come from an older form of Basic!) with PROCwait(2). (*Incidentally, I'm inclined to wonder why PROCthrow has a different delay for each side, in lines 610 and 620.*)

The pattern soon becomes obvious. If you find yourself writing a piece of program for the second time, consider whether it could be a procedure. If you write it a third time, make it a procedure. Not only will you save space, but you'll also reduce your effort, both in the writing of the program and in the making of any alterations later required to that piece of code.

### Taking code outside loops

Why ask the computer to do more than it needs to? If you really want to slow it down, you can always use PROCwait. The command GCOL4,0 occurs at the start of line 410, and again further on in the same line (or in line 420, if the other path was taken).

Why the second GCOL4,0? Nothing has happened in the meantime to undo the effect of the first one.

A more extreme case is found in line 570. GCOL0,2 is performed 50 times, inside a FOR loop. One call before entering the loop would give exactly the same picture, but with a lot less work on the computer's part - that is, a lot faster.

All right, the picture isn't drawn particularly slowly, but the same principle applies in cases where speed is more critical. A programmer who learns good habits from the start isn't likely to forget them when it matters.

The principle also applies to IFs. Line 600 says effectively "IF this THEN a: b ELSE a: c". The IF must certainly encompass b and c, but why

# INSIDE KING KONG

repeat a? A better statement would be W%=680: V%=(Y%-680)/20\*DIF%: IF X%>604 THEN Q%=710: H%=(X%-710)/20\*DIF%: ENDPROC ELSE Q%=540: H%=(X%-520)/20\*DIF%: ENDPROC.

### Giving procedures parameters

When King Kong is to be drawn, the program first sets ARM% to the height at which the arms are to be drawn, then MOVES to the place where it wants to start drawing Kong, then calls PROCkong.

The procedure then draws the body, MOVES to a fixed x-position and the ARM% y-position and draws the left arm, MOVES to another fixed x-position and the ARM% y-position and draws the right arm.

There are two problems with this. First, the program takes on a lot of the effort in setting ARM% and MOVEing to the right place. Second, although it doesn't arise in this program, any attempt to draw Kong at an x-position other than 600 will detach his arms, which are drawn at a fixed x-position regardless of where the body is.

Both of these problems can be over-

come with amazing ease by passing the starting position to the procedure as a pair of parameters. Look at this version of the procedure:

```
DEF PROCkong(A%,B%)
  GCOL0,2: MOVEA%,B%:
  VDU224,229,...233,238
  MOVEA%-60,B%-20: VDU
  241,239: MOVEA+90, B%
  -20: VDU239,240
ENDPROC
```

Kong can now be drawn at, say, (600,700) simply by calling PROCkong(600,700). No MOVEing first, no messing about with ARM%, no worries about detached arms. Surely it's worth it.

We can do a similar thing with the girls:

```
DEF PROCgirl(A%,B%)
  MOVEA%,B%: VDU242,10,8,
  243: ENDPROC
```

This is such a small procedure that you must wonder whether it's worth it. But look at the MOVES and VDUs it saves (in PROCsetup, PROCpick and PROCcheli), and notice how much more readable

```
PROCgirl(X%+30,Y%-30)
```

is than

```
MOVE%+30,Y%-30: VDU242,10,8,
243
```

You can actually see the program's intention in the former!

Just to emphasise the difference a little more, look at PROCsetup (line 590). The old version can now be replaced by

```
DEF PROCsetup: PROCskysc:
  PROCkong(600,700): GCOL(0,3):
  PROCgirl(460,360): PROCgirl
  (790,360): ENDPROC
```

Even allowing for the multiple-statement line, this is surely a lot easier to understand than the old version.

### Testing conditions

Two points struck me in this area. First, many of the conditions tested in the program can be simplified quite significantly. And second, there are a couple of rather odd conditions being tested, which fall into two categories - the unnecessary and the impossible.

As an example of the former, think about IF PICK%=0 OR Y%>120 OR PICK%=0 AND Y%>120, found in line 660. As an example of the latter, try IF Y%<300 AND Y%>390, in line 630. Neither of these actually affects the program's outcome, but they really shouldn't be there.

And the simplifications? It's really

## From Page 45

the same old principle. If you find yourself repeating the same code over and over, can it be turned into a procedure? I should have added "or a function?"

Look at the number of times the program tests whether something lowval and something highval. I've found 13, and I don't guarantee to have noticed them all. So let's write a function `DEF FNin(X%,low%,high%) = X% >= low% AND X% <= high%`.

Every one of those awkward conditions can now be replaced with something like `IF FNin(X%,720,900)`. Space is saved, the program becomes a little easier to read, and there is the added bonus of discouraging such conditions as `IF X%+90<590 AND X%+270>=590`.

At the end of all this, we can usefully rewrite `POChitcheck` as follows:

```
450 DEF PROCChitcheck: IF
  FNin(Y%,600,650) THEN GOTO
  460 ELSE IF FNin (Y%,651,694)
  THEN GOTO 480 ELSE END
  PROC
460 IF FR%=16 AND FNin
  (X%,320,499) OR FR%=-16
  AND FNin(X%,721,900) THEN
  PROChit
470 ENDPROC
480 IF FR%=16 AND FNin
  (X%,290,469) OR FR%=-16
  AND FNin(X%,751,930) THEN
  PROChit
490 ENDPROC
495 DEF PROCChit: HITKONG%
  =HITKONG%+1: SCORE%=
  SCORE%+20: PROCupdatescore:
  PROCchnextsheet: ENDPROC
```

The procedure still has a little scope for improvement, but it's a lot better than the original.

## Character sizes and positions

When printing characters at graphics cursor positions, the programmer

should always be aware of character size.

For the sake of brevity I shall use the word "pixel" to represent a unique screen address – it is, in a sense, a notional pixel. In Mode 1, a character is then 32x32 pixels in size. But the program doesn't seem to accept this.

Consider Kong's arms. Each consists of two consecutive characters, and

# INSIDE KING KONG

so is 64 pixels wide – but the left arm is drawn 60 pixels back from the body, leaving an overlap of 4 pixels.

Perhaps this was intended – but if so, why does the right arm overlap by 6 pixels? It is drawn 90 pixels on from the start of the body, rather than the 96 one might expect in order to move past three characters.

Consider the helicopter. It consists of three consecutive characters, yet there seems to be a consistent assumption that it is 90 pixels wide – look at `PROCpick` and `PROCChitcheck` for the most obvious evidence.

And last, look at the way `PROCChitcheck` decides whether Kong has been hit. The vertical check is fairly straightforward. Anything at the same level as the arms or upper torso will be considered. Nothing outside that region has a chance (although a missing `Y%` in line 420 will give a rather odd appearance to all leftward shots!).

But the horizontal checking really

seems a matter of guesswork (I almost avoided saying "Hit-and-miss"!). Each shot is drawn over 180 pixels and is valid over a range of 179 pixels, which seems fair enough. There is thus a maximum distance beyond which no shot is effective, which also seems fair enough.

The odd things are, first, that there is also a minimum distance – get too close and you'll miss – and, second, that the minimum and maximum vary almost randomly for the different types of shot.

Shooting left at the torso, you'll miss if you're closer than 25 pixels; shooting right at the torso, you'll miss if you're closer than 4 pixels; shooting left at the arms you can actually overlap the arm by 3 pixels and still score (you can overlap either arm quite significantly without crashing); and shooting right at the arms you can overlap by 26 pixels!

Such inconsistency is easily avoided with a little thought, and is well worth it in the finished product.

## Boolean variables

The program makes much use of most of the special features of BBC Basic, but seems to ignore the very useful concept of Boolean variables – values which can be either TRUE or FALSE.

`PICK%`, `FLAG`, `LGIRL%`, and `RGIRL%` are all begging to be used in this way. Their values are only ever 0 or 1, and they are used throughout to indicate whether certain conditions are true or false.

Look at `PICK%` – set to 0 to start with, to 1 when a girl has been picked up, and back to 0 when she is put down.

In other words, `PICK%=FALSE` to start with, TRUE on pickup, FALSE again on drop.

It is not only the assignments which make more sense to the reader this way. Look what happens to the tests: `IF PICK% THEN . . . : IF NOT RGIRL% THEN . . .`

And the bonus that goes with the improved readability? The programmer doesn't have to remember little details like "If it's 1, it is, and if it's 0, it's not" – the computer now takes care of that.

## Natural looping

Generally speaking, the program



New readers might like to know that the original listing for the King Kong game appeared in the April issue of The Micro User. The game was also the main program on that month's cassette tape.

Both the magazine and the tape can be obtained by using the order form on Page 73.

# Eltec HOME & BUSINESS TECHNOLOGY computers

Probably the widest selection of software available by mail order.  
All the top manufacturers including Acorn Soft, IJK (Sinclair), Superior Software, Bug Byte, Program Power, Hessel, Procyon.

All NEW  
All in Stock  
(as long as you're quick)

## BBC MICRO COMPUTERS

BBC MICROCOMPUTERS, with the latest 1.2 operating system Model B **£399** FREE Acornsoft game with every computer

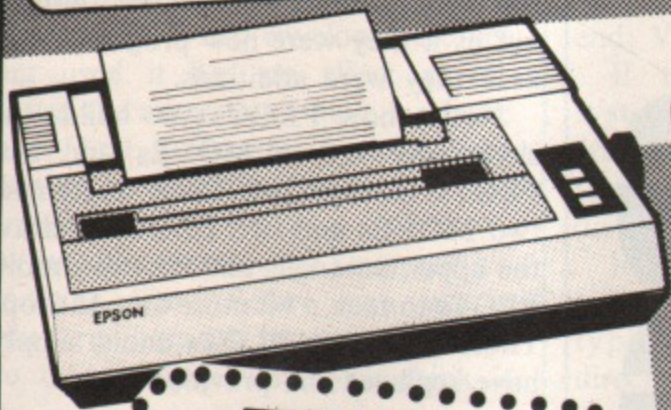
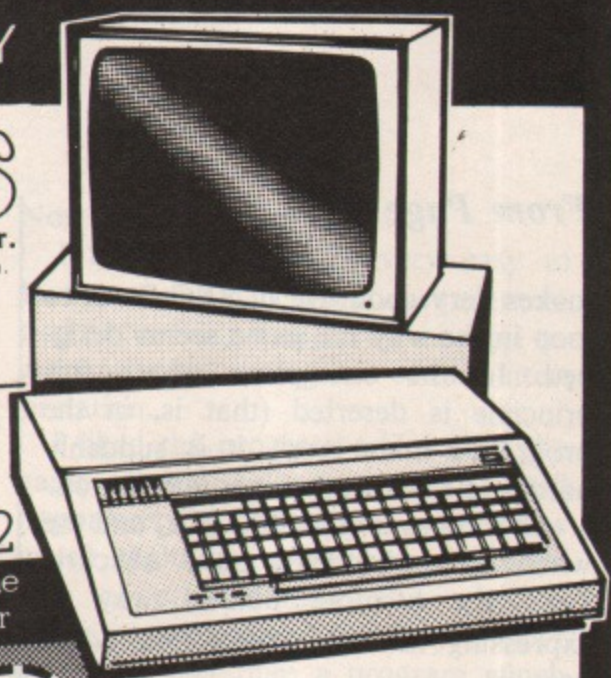

## EPSON

New Epson FX80 F/T III Printer  
160 c.p.s. Parallel **£450.00**

## ATPL EPROM PROGRAMMER

Make your favourite programs full time residents with an ATPL EPROM PROGRAMMER **£138.00**. Program, verify, read and check for blank, 2716, 2732, 2764, 27128, 27256. Single Rail Eproms. Also Eprom Eraser **£55.20** incl.

## PRESTEL

PRESTEL Available now on the BBC Micro OEL Acoustic Modem & Software & Lead. Converts the BBC Micro into a Prestel/private viewdata receiver. **£175.00** all inclusive.

**BBC**  
BBC Data Cassette available from stock now **£29.90** incl. cable

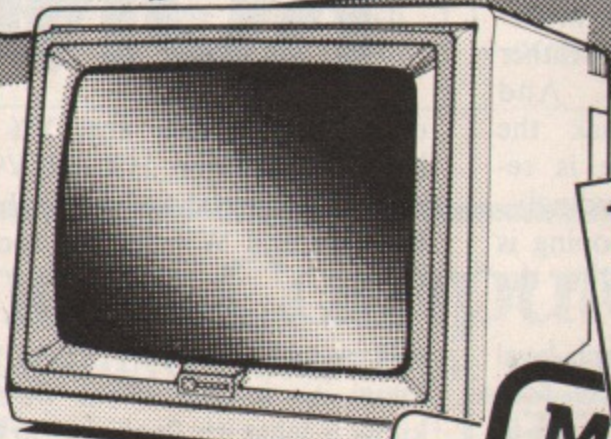

**TEAC**  
TEAC 40T/80T Switchable double sided Disc Drive 200K/400K **£366.85**

Full service for Education

## Microvitec

Microvitec "Cub" Monitor. True 80 Column Definition at a new low cost from **£459.00**

### PROTECTIVE COVERS AND CARRYING CASES

- Polyester Cotton Cover. . . . . 3.97
- Soft PVC Cover. . . . . 4.45
- Hard Carrying Case . . . . . 55.20
- Soft Carrying Case . . . . . 23.00
- Cassette leads. . . . . 4.00

### SOFTWARE

- Killer Gorilla, Program Power 7.99
- Road Runner, Superior Software 7.50
- Centipede, Superior Software 7.50

### JOYSTICKS AND SOFTWARE

- BBC Joysticks - pair. . . . . 13.00
- BEEBSTICK - Fully proportional for Computer Aided Design. . . 29.75
- JOYSTICKS GRAPHICS - Draw and Save your own Line Diagrams. . . . . 5.75
- JOYSTICK PACK 1 - Contains "ZAP" and "ETCH A SKETCH" . . . . . 5.75
- GRAPHSTICK - Computer Aided Design for any joystick. . . . . 7.95

### HARDWARE

- Sound Pick-off Module (Simple to fit). . . . . 6.95
- Loudspeaker in cabinet plus cable for above pick-off. . . . . 27.00
- Loudspeaker plus Amplifier for above pick-off (Blaster). . . . 37.50
- R.H. ELECTRONICS light pen incl. software . . . . . 45.94

ELTEC COMPUTERS  
217 Manningham Lane, Bradford, BD8 7HH.  
Tel (0274) 722512.

All above prices include VAT

For full price lists or further details of any products send s.a.e.



## From Page 47

makes very good use of BBC Basic to loop in the way the game seems designed. In the one place where this principle is deserted (that is, in the program's main loop), it is suddenly harder to see exactly what is going on.

All it takes is three GOTOs, and the whole thing becomes quite obscure. Let's try a more natural way of expressing the same thing (see panel below).

To me, at least, this expresses the whole loop a lot more clearly than the original version. Notice, too, how it delegates its authority.

Plotting the scoreboard and the helicopter and sounding the fanfare are all part of the setting-up routine – so have them called by PROCsetup. The rock and its loop counter can all be dealt with in one go, so get a PROCrock to do it.

The explosion and gameover procedures can set "exploded" to true, rather than setting FLAG to 1. And PROCgameover can also ask the player whether another game is required, setting "finished" accordingly.

Another case for natural looping is in PROCskysc, which builds the skyscraper.

A for-loop is used to plot each level of windows, but within a level four separate calls to PROCwin are made to plot the four windows.

Why not another for-loop? FOR L%=20 TO 250 STEP 40: FOR

M%=550 TO 710 STEP 40: . . .

### Variable names

When speed is required, it does make sense to use the resident integer variables A% to Z%, but because this practice reduces readability care should still be taken in selecting them.

Again, this program has generally

# INSIDE KING KONG

done well – X% and Y% for the helicopter position, H% and V% for the rock's horizontal and vertical speeds – but Q% and W% for the rock's position?

Most of the other variables are very well named. But why FLAG? We all know it's a flag. What we'd like to know is what it's flagging – in this case, "exploded".

Apart from readability, a great advantage of meaningful names is that

it helps us to keep track of just what variables there are.

Two of the variables in King Kong, FLAG1 and R%, are never used – something which the programmer would have noticed far more readily if they'd had useful names.

### Copying with afterthoughts

One often wants to modify a program after writing it. This is quite natural, and nothing to be ashamed of. But modifications should be thought out as if they were new programs, not as if they were additions.

Notice how PROCskysc builds the skyscraper – two MOVEs and two PLOTs to draw the lower rectangle, two MOVEs and two PLOTs to draw the upper rectangle, and then two more PLOTs to tack a bit more onto the top! Those two extra PLOTs could simply have replaced the previous two.

### Keeping track of what's been done

When writing a program, don't assume what state the computer is in – think about it. What has happened at the keyboard when we get to line 30? Somebody has just typed RUN and pressed RETURN. So why clear the keyboard buffer?

Where is the DATA pointer when we get to line 730? We've just done a RESTORE 750, and read all the data there, so it must now be on line 760. Which makes the RESTORE 760 a little pointless.

Why clear the screen in line 250? It's just been cleared in line 230 – or would have been if it weren't for a little point mentioned in the next section.

But why clear it at all in PROCinit, when PROCinstructions is about to clear it again without further ceremony?

### Miscellaneous points

PRINT takes as many arguments as you like, up to the end of a 240 character line. That means we can PRINTTAB(5,2); HITKONG%; TAB(16,2); SCORE%;TAB(23,2); SHEET%;TAB(29,2). Much better than repeating the PRINT command before every TAB.

GET stops the program until a key

```
PROCinit: PROCinstructions
```

```
REPEAT
```

```
PROCsetup: REM Which calls scoreboard, fanfare, and heli.
```

```
REPEAT
```

```
PROCrock: REM Unplot the rock, then replot or throw it.
```

```
PROCplayer: REM Essentially PROCcheckkeys.
```

```
IF FNhit THEN PROCexplosion
```

```
UNTIL exploded
```

```
UNTIL finished
```

```
END
```



has been tapped. So REPEAT UNTIL GET -1 has exactly the same effect as dummy=GET. There will be no repetition involved.

When a SOUND command is issued with a value like &1001, it means that a dummy note is to be played, at no volume, overlapping the release of the previous note in the same channel. The purpose of this is to ensure that the next non-dummy note doesn't interrupt the release.

Issued at the end of a piece of music it has no effect at all, because there is no next note. When envelopes are not being used it has no effect at all, because the notes don't have a release phase. And a dummy note of zero duration wouldn't overlap a lot anyway.

What's the moral here? I suppose it's something like "Before you use a facility, run little test programs to make sure that it does what you think it does."

Returning to the instructions on

error is all very well for a running program, but can be rather depressing during the debugging. A more useful trap would be along the lines of ON ERROR IF ERR=17 THEN GOTO 50 ELSE REPORT: PRINT ERL.

This still treats ESCAPE as a request for instructions, but reports any other error as expected.

There is a misprint in the User Guide which I imagine has caused a lot of anguish among programmers. The VDU statement which turns the cursor off should have a semi-colon at the end: VDU23;8202;0;0;0;

If the semicolon is missed, the system will still want one more byte to complete the command, and will just take the next byte sent to the VDU drivers.

In line 230, that next byte is a VDU12, under the guise of CLS. Try typing VDU23;8202;0;0;0: CLS directly into the computer, and you will see that the cursor has indeed been turned off, but that the CLS has failed.

Not very nice, that.

I know it would be very easy to interpret this article as a condemnation of the King Kong program, so I re-emphasise the wrongness of that interpretation.

I liked the program and I liked the game. I simply saw it as a good opportunity to make a few suggestions which might lead most of us to a better way of programming. But what is better programming? Surely you can't get any better than a program which works as required? I think you can.

I think you can get a program which works faster where speed is required by avoiding unnecessary repetition. I think you can get a program which takes up less memory, leaving more room for expansion.

And I think you can get a program which both you and others will find easier to read and understand, and thus easier to debug and modify.

That's not a bad reward for learning to program the way you think!

# Home & Business Computers

THE NORTH'S LEADING COMPUTER SUPPLIERS



## HARDWARE

BBC MODEL B £399  
DISC I/F KIT £99.95 (Fitted)  
Wide range of add-ons

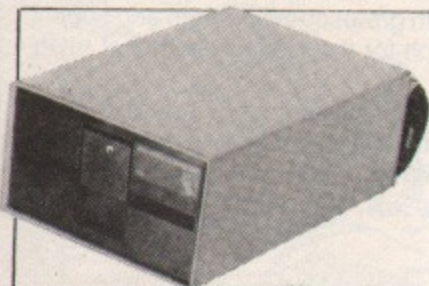

## DISC DRIVES

(inc. Utilities Disc and Manual)  
TEAC 100K singled sided £230  
TEAC 200K single sided £305  
TEAC 400K double sided 80 track £397  
New Slimline 100K Disc Drives £205  
Plus LVL/Acorn Disc Drives



## SOFTWARE - from £4.50

Micropower, Salamander, Digital Fantasia, Acornsoft, IJK, BBC Soft, Bug Byte, etc.

ALL PRICES INCLUDE VAT AT 15%

PRINTERS AP 100A £229 SPARKJET £420  
RX 80 £329 FX 80 £499

SEND FOR PRICE LIST

## SERVICE AND SUPPORT BY FERRANTI

### OLDHAM

54 Yorkshire St., Oldham, Lancs.  
Tel: 061-633 1608

### ROCHDALE

73 Yorkshire St.,  
Rochdale OPENING JUNE

## EDUCATION AND BUSINESS USERS

We offer:

- Wide range of Business and Educational Software.
- Educational and bulk order discounts.
- Warranty and post warranty maintenance.
- On site maintenance if required.
- Collection and delivery of repairs if required.

UK MAINLAND MACHINE DELIVERY £5.00





# MYSTERIOUS ADVENTURES

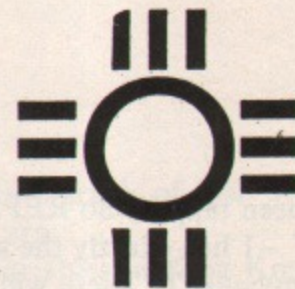

## FOR BBC MICROCOMPUTER MODELS A & B\*

Join the growing band of Adventurers who are enjoying these absorbing and stimulating programs. Step into another world of Fantasy, Magic, Mystery and Sorcery. Only your wits and cunning can ensure success in these scenarios!



- WRITTEN IN ULTRA-FAST MACHINE CODE.
- SAVE GAME FEATURE.
- SPLIT SCREEN DISPLAY.

1. **THE GOLDEN BATON** — Venture into a strange province of Sorcery and Evil Magic to recover the Golden Baton, a priceless artifact whose powers are said to bring great Health and Prosperity to the Land.
2. **THE TIME MACHINE** — As a Newspaper reporter you are sent to investigate the eccentric professor who lives in the old house on the Moors. What is his secret and why is his house now deserted?
3. **ARROW OF DEATH (Pt. 1)** — A blight has fallen on your homelands, the Baton has become tarnished and now radiates a malevolent aura of Evil. Your mission is clear — trace the source of this Evil and destroy... or be destroyed. This is the first part of an Epic Adventure although each part can be played as a stand alone scenario.
4. **ARROW OF DEATH (Pt. 2)** — You now have the means to destroy your enemy... but you are far from home and this land is strange to you. Can you cope with the deadly perils which approach you and have you the strength to see your mission through to the final conflict?
5. **ESCAPE FROM PULSAR 7** — Alone on a gigantic Space-Freighter... The rest of your crew have died horribly at the hands of a mutated Zoo-Specimen. Your only chance of escape is to reach the Frail Shuttlecraft. But the lurking Monster is hungry and you are the only food it has left...
6. **CIRCUS** — Your Car has run out of Petrol on a lonely road miles from habitation. As you trudge reluctantly down the road in search of help you are suddenly confronted by an amazing sight... in a nearby field is a Huge Circus tent! But this is no ordinary Circus as you will soon discover...
7. **FEASIBILITY EXPERIMENT** — Far across the gulfs of time and space, a dying race of super-intelligent beings search the Universe for a Hero to save their existence... At length their thoughts turn to planet Earth. You are chosen to be their saviour in a bizarre scenario where death is a mere thought away...
8. **THE WIZARD OF AKYRZ** — You are in the Royal Palace. The King beseeches you to rescue his daughter from the evil wizard. If you succeed your reward will be priceless... failure will bring certain death.
9. **PERSEUS AND ANDROMEDA** — Travel into the realms of ancient mythology. Battle with grotesque monsters and supernatural powers as you search for the hidden secrets of myth and legend.
10. **TEN LITTLE INDIANS** — This mystery begins with a train journey into a strange country. What secrets are held by the strange country mansion? What meaning is attached to the strange idols? Maybe you will find out if you live long enough...

\* Adventures 5-10 inc. require 32K RAM

Each adventure comes attractively packaged for just £10.29 inc.

Available soon for ZX SPECTRUM, ZX81 (16K), APPLE II.



SEND CHEQUE OR P.O. TO:

**DIGITAL FANTASIA**

24 NORBRECK ROAD, NORBRECK, BLACKPOOL, LANCASHIRE.  
Tel: (0253) 591402



# We've got it all taped!

**BBC  
MICRO  
USER**



**Deathwatch**

and 24 other programs listed in the pages of **BBC Micro User** Vol. 1, No. 1.

**BBC  
MICRO  
USER**

**KING KONG**



and 22 other programs listed in the pages of **BBC Micro User** Vol. 1, No. 2.

**BBC  
MICRO  
USER**

**AIR STRIKE!**



and 33 other programs listed in the pages of **BBC Micro User** Vol. 1, No. 3

## March Issue

**DEATHWATCH**, a superb arcade game that challenges you to use your skill to fight off enemy battleships, tanks and helicopters; **BINGO**, illustrating clever uses of the randomise function; **BUBBLESORT** routines; **TESTS** for function keys in machine code routines; a useful **CASSETTE BUGS FIX** for users with OS 0.1 . . . and many **COLOUR** and **GRAPHICS** **ROUTINES** to help you create a kaleidoscope of screen designs which you can incorporate into your own programs.

## April Issue

**KING KONG**, a fast moving game in which you pilot a helicopter to rescue girls perched on the Empire State Building before killing Kong; **GRAPHICS**, a suite of colourful demonstration programs; **NIM**, a structural game of strategy; **TOKENS**, first steps in unravelling the Basic ROM; **HOROSCOPES**, a fun program with useful error-trapping routines; **FORMATTER**, an essential disc utility; **DISASSEM**, a full machine code disassembler; **HEAT & LIGHT**, two measuring and plotting programs.

## May Issue

**AIR STRIKE**, a fast and furious arcade game; Test your mental powers with **PELMANISM**; 25 **ANAGRAMS** for you to solve; **CHARACTER**, to generate vertical and inverted text; **TELETEXT**, animation in Mode 7, really brings the screen to life; **LAB**, a trio of programs to interface laboratory equipment; 10 programs to investigate the **OSBYTE** routine; **BEEB**, two joystick exercises; plus more **COLOUR** and **GRAPHICS** routines.

**THE  
MICRO  
USER**



**SPACE PILOT**

and other programs listed in the pages of **BBC Micro User** Vol. 1, No. 4.

## June Issue

**SPACE PILOT**, lost in space with dwindling fuel supplies, you must fight off repeated attacks from alien life forms. To replenish fuel, you have to perform a tricky docking manoeuvre, while to repair the inevitable damage you must land on a mountainous planet. **NOMISM**, you are a nomadic herdsman desperately trying to eke out a living on the plains of Africa. Can you survive drought, tsetse fly and other hazards? **PLUS** other listings from the June issue.

**THE  
MICRO  
USER**

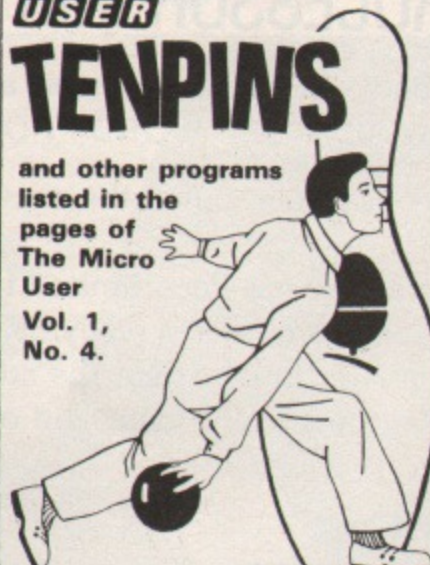

**TENPINS**

and other programs listed in the pages of **The Micro User** Vol. 1, No. 4.

## July Issue

**TENPIN**, a highly entertaining simulation of Tenpin Bowling; **SPACEPODS**, Try to beat alien hordes; **CUP**, Exciting techniques to bring 3D graphics to the BBC Micro; **SCRSAVE** and **CSRLOAD**, Two programs to allow you to save and load screens to tape or disc; **TEST** and **STEADY**, A pair of programs to accompany the Beeb body Building Course; **BREAKFIX**, Don't let the Break key destroy all your precious variables! **FORMAT**, Creates neater listings.

**THE  
MICRO  
USER**

**FRUITIES**



and other programs listed in the pages of **The Micro User** Vol. 1, No. 6

## August Issue

**FRUITIES**, driven by strange urges you climb the ladders of adventure to risk all in the gardens of unearthly frights. Can you survive all the terrors that await you, or will you, too, fall victim to the evil Fruities? A really superb game. **ANIMATION**, a suite of programs that show you how to really bring your screen alive; **CASDISC**, The essential machine code downloader for your disc system; **PLUS** other listings from the August issue.

**£3.75**  
each (incl. p&p)

Save wear on your fingers – and ensure your programs are error-free – with the top-quality cassettes of programs listed in *The Micro User*.

**ORDER FORM  
ON PAGE 73**

RICKSOFT

BBC

RICKSOFT

LIBRARY

# SOFTWARE

... Arcade Games ... Adventures ...  
Educational ... Utilities ... Languages ... ROMS  
... and more

... coming soon ...

**Discs, Light Pens, Graphics Tablet.**

**HIRE**

Most from £1  
per fortnight

Membership £10

For catalogue and membership  
form send name and address to

**BUY**

With up to  
25% discount

**Ricksoft, 78, Warren Drive,  
Hornchurch, Essex RM12 4QX.**

RICKSOFT

## DO YOU WANT A WORD PROCESSOR FOR YOUR BBC OR A WORD PROCESSOR FOR YOUR BBC ?



Yes there is a difference between word processors and we can offer the best because it's the FIRST PROFESSIONAL DISC BASED WORD PROCESSOR FOR THE BBC COMPUTER.

The MERLIN SCRIBE uses the disc on your computer the same way that professional systems costing many hundreds of pounds do.

Until now any document you wished to create has been limited to the few pages which could be squeezed into your computer memory. This means the computer is really using the disc as if it were a cassette!

The SCRIBE can create documents far greater in size than the computer memory, and really uses the disc as it was intended to be used. SCRIBE automatically loads and offloads pages between disc and memory without you even knowing it's happening!

Amongst the many super features available are:

- \* Optional 40 & 80 column screen format selection.
- \* On screen formatting - you see it as it's printed INCLUDING UNDERLINING.
- \* Right justify, word wrap, insert, delete, move copy & centre.
- \* Document merge (will merge two documents into one from disc).
- \* Addresses all four drive units allowed by your BBC disc system.

Plus many more professional features.

SCRIBE comes in ROM with five minute fitting instructions, printer utilities on disc and a comprehensive manual.

PRICE £59.95

Also MERLIN SCRIBE in ROM for cassette machines £29.95, and on tape £19.95. All prices include VAT. Post and Packaging 60p.



MERLIN COMPUTER PRODUCTS (BUCON LIMITED)  
18 MANSEL STREET, SWANSEA, SA1 5SG. TEL (0792) 467980



# The new Seikosha Graphics Printer.



Here it is in **Colour**



Here it is in **Black & White**

Here it is at last, the colour graphics Seikosha printer.

Same constant reliability, same versatility and same habit of shattering price barriers – just £425.

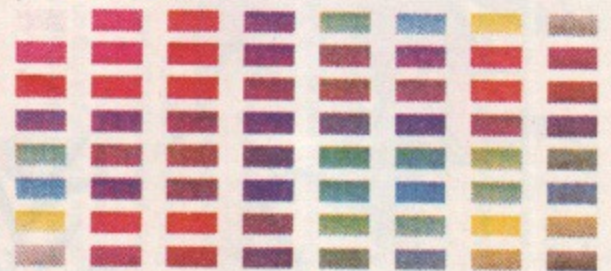

- Unique 4 hammer head mechanism prints 7 colours or 30 shades in a single pass.

- High quality graphics with colour specification by dot units.

- Colour mixing without smearing.

- 50 characters per second whatever the colour mix.

- 80 and 106 characters per line.

- Pin feed and friction feed.

- Unique 4 colour ribbon with reinking reservoirs for long-life colour.

- Centronics Parallel interface with serial (RS232) and Video (RGB) interface options.

Telephone the number below and we'll tell you where your nearest dealer is located.

**DRG**  
**BUSINESS**  
**MACHINES**

(Peripherals Division),  
13-14 Lynx Crescent,  
Winterstoke Rd, Weston  
super Mare. BS24 9DN.  
Tel: (0934) 419914.

DEALER  
ENQUIRIES  
WELCOME



## WORD PROCESSING

		Continued from Part 1						
Title	Description	Model A	Model B	Joystick	Keyboard	Price		Supplier
						Disc	Cassette	
View	Word processing ROM with manuals.	●	●			£59.80		Acornsoft
Viewtext	Teletext lookalike offering features Ceefax and Oracle. Powerful Teletext Editor.			●		£13.95	£9.95	IT Services

## Part 3

# THE MICRO USER

## Programs featured in this Guide are supplied by:

**Acornsoft**, 4a Market Hill, Cambridge; **BAKsoft**, 34 Humberstone Road, Cambridge; **BBC Micro User**, Europa House, 68 Chester Road, Hazel Grove, Stockport; **Beebsoft**, Room 107, 35 Marylebone High Street, London W1M 8AA; **Boume** Educational Software, Bedford Lane, Headbourne Worthy, Winchester, Hants; **Bryants**, 1 The Hollies, Chalcraft Lane, North Bersted, Bognor Regis PO21 5SX; **Busco**, 16 Colwill Walk, Mainstone, Plymouth; **Carvella**, 3/7 Bank Street, Rugby; **CUP** (Cambridge University Press), Edinburgh Building, Shaftesbury Road, Cambridge; **CPE** (Central Program Exchange), The Polytechnic, Wolverhampton; **Chalksoft**, Lowmoor Cottage, Tonedale, Wellington, Somerset; **Clares** Micro Supplies, Providence House, 222 Townfields Road, Winsford, Cheshire; **CMS** (Computer and Media Services), Sherwood, Woodhouse Lane, Holmbury St. Mary, Dorking, Surrey; **Computer Concepts**, 16 Wayside, Chipperfield, Herts; **Computercat**, 224 Chapel Street, Leigh, Lancs; **Corona** Software, 73 High Road, S. Woodford, London; **Cottage** Software, Heather Cottage, Selly Hill, Whitby, N. Yorkshire; **Cortex** Computing, 15 Woodlands Close, Cople, Bedford; **DACC**, 23 Waverley Road, Hindley, Lancs; **Database**, 27 City Road, Stoke, Staffs; **Dial** Software, 72 Downend Road, Downend, Bristol; **Digital Fantasia**, 24 Norbreck Road, Norbreck, Blackpool; **Electronics Applied**, 4 Dromore Road, Carrickfergus, Co. Antrim; **Focusplan**, Focus House, 57 Westgate, Cleckheaton, W. Yorks; **Gaelsett** Software, 44 Exeter Close, Stevenage, Herts; **Garland** Computing, 35 Dean Hill, Plymouth, Devon; **GEM** Software, 1 Oswald Road, Leamington Spa; **GED**, 70 Stoke Road, Bletchley, Milton Keynes; **GJ Associates**, 35 Donovan Avenue, London; **Golem**, 77 Qualifax, Bracknell, Berks; **Griffin & George**, 285 Ealing Road, Alperton, Wembley, Middlesex; **GT Software**, 8 Bull Street, Potton, Sandy, Beds; **H & H** Software, 53 Holloway, Runcorn, Cheshire; **J. Hargreaves**, Updown, Pewley Way, Guildford, Surrey; **Heinemann** Computers in Education, 22 Bedford Square, London; **Simon W. Hessel** Software, 15 Lytham Court, Cardwell Crescent, Sunninghill, Berks; **Hexagon** Software, 17 Straits Road, Gornal, Dudley, West Midlands; **Hopesoft**, Hope Cottage, Winterbourne, Newbury, Berks; **IJK** Software, 9 King Street, Blackpool, Lancs; **IT Services**, 27 Watford Park, Radstock, Avon BA3 3GS; **Kansas City** Systems, Unit 3, Sutton Springs Wood, Chesterfield S44 5XF; **Kingfisher** Computer Services, Durlley Lane, Keynsham, Bristol BS18 2AQ; **Koosmos** Software, 1 Pilgrims Close, Harlington, Dunstable, Beds; **Level 9** Computing, 229 Hughenden Road, High Wycombe, Bucks; **Logic** Systems, 85 Hemingford Road, Cam-

bridge; **Longman** Group, Longman House, Burnt Mill, Harlow, Essex; **David McKeran**, 23 Warwick Drive, East Herrington, Sunderland, Tyne & Wear; **Mayday** Software, 181 Portland Crescent, Stanmore, Middx. HA7 1LR; **MED**, 640 Melton Road, Thurroaston, Leics. LE4 8BB; **MGB** Software Support, 52 Barley Croft, Harlow, Essex; **Micro-Aid**, 25 Fore Street, Praze, Cambridge, Cornwall; **Micro-Jenn** Software, 81 Squirrels Heath Road, Harold Wood, Essex; **Micromode**, 32 West End Avenue, Gatley, Ches; **Microplus** Software, 6 Litton Way, Leeds; **Micro Power**, 8/8a Regent Street, Chapel Allerton, Leeds; **Microwave NW**, 24 Belford Road, Stretford, Manchester; **MP Software**, 165 Spital Road, Bromborough, Wirral, Merseyside; **NEC** (National Extension College), 18 Brooklands Avenue, Cambridge; **Ordura** Consultants, PO Box 179, Sheffield; **Paean** Systems, Wuebec House, Little Bealings, Woodbridge, Suffolk; **Primasoft**, 2 Spinney Close, Glossop, Derbys; **Pro Software**, 121 Tyn-y-Twr, Baglan, Port Talbot, West Glam; **Processor** Applications, 22 Mercer Close, Basingstoke, Hants; **RMK** Electronics, Hinton House, Station Road, New Milton, Hants; **Ross** Software, 44 Premier Avenue, Grays, Essex; **Salemander** Software, 27 Ditchling Rise, Brighton, Sussex; **Schoolsoft**, 19 Shadwell Grove, Radcliffe-on-Trent, Nottingham; **Secta** Software, 14 Bracadale Close, West Coombe Park, Coventry; **Simonsoft**, Front Street, Topcliffe, N. Yorks; **Smaah Hit** Software, 11 Calfridus Way, Bracknell, Berks; **Softefax**, 11 All Saints Road, Creeting, St. May, Ipswich; **Software Invasion**, 50 Elborough Street, Southfields, London; **SolarSoft**, 5 Westmorland Drive, Camberley, Surrey GU15 1EW; **Square** Software, 12a Uplands Terrace, Swansea, W. Glamorgan; **Squirrel Stable** Software, Compton Street, Compton, Nr Winchester, Hants; **Superior** Software, 69 Leeds Road, Bramhope, Leeds; **Virgin Games**, 61-63 Portobello Road, London W11; **Zero** Software, 29 St. Michael's Close, North Walthams, Basingstoke, Hants.

Part 1 and 2 of the Guide to Software for the BBC Micro appeared in the June and July issues of *The Micro User*. Copies cost £1.25 each and can be obtained by filling in the order form on Page 73 of this issue, or by writing to: **The Micro User**, Europa House, 68 Chester Road, Hazel Grove, Stockport SK7 5NY.  
● While every care has been taken in compiling details for this Guide, no responsibility can be accepted for any errors or omissions.

# Guide to Software for the BBC Micro

## GAMES

Title	Description	Model A	Model B	Joystick	Keyboard	Price		Supplier
						Disc	Cassette	
20 Crosswords	A tape of 20 ready made crossword puzzle files for playing on the Crossword Puzzler program.	●					£6.90	NEC
Arcade Action	Four arcade type games, Snake, Invaders, Breakout, Dodgems.	●		●			£11.90	Acornsoft
Arcadians	Defend against swooping arcadians.	●		●		£11.50	£9.95	Acornsoft
Bomb Alley	3D Falklands Battle simulation (machine code hi res graphics).	●		●			£7.95	Software Invasion
Bomber Scramble	The original and most effective scramble published.	●		●				Kansas
Bug Bomb	A skin tingling new arcade game.	●		●			£7.95	Virgin Games
Car Race	Try to guess which car will win the race. Ideal for fund raiser for school fetes.	●		●			£6.90	Kingfisher
Castle of Riddles	Adventure takes place in a castle.	●		●		£11.50	£9.95	Acornsoft
Chess	Chess playing and program solving program.	●		●		£11.50	£9.95	Acornsoft
Cosmic Fighter	A fast action multi screen arcade game.	●		●				Kansas City
Countdown to Doom	Science fiction adventure.	●		●		£11.50	£9.95	Acornsoft

Continued from last month

Title	Description	Model A	Model B	Joystick	Keyboard	Price		Supplier
						Disc	Cassette	
Dracula Island	A traditional adventure game. Ideal for starters.	●	●	●	●			Kansas
Draughts & Reversi	Play two board games against the computer.	●	●	●	●	£11.50	£9.95	Acornsoft
F for Freddie	One of the hardest games you will ever play.	●	●	●	●			Kansas
Galactic Firebird	One of the most active arcade games on the market today.	●	●	●	●			Kansas
Hopper	Hop a frog across a road and river.	●	●	●	●	£11.50	£9.95	Acornsoft
Landfall	An exciting and realistic spaceship landing simulator.	●	●	●	●		£7.95	Virgin Games
Magic Adventure	A wonderful colourful magic adventure for children.	●	●	●	●			Kansas
Meteors	Shoot meteorites.	●	●	●	●	£11.50	£9.95	Acornsoft
Missile Base	Defend your cities from attack.	●	●	●	●	£11.50	£9.95	Acornsoft
Monsters	Trap monsters by digging holes and filling them in.	●	●	●	●	£11.50	£9.95	Acornsoft
Philosopher's Quest	Unusual adventure.	●	●	●	●	£11.50	£9.95	Acornsoft
Planetoid	Return life forms to the planetoid.	●	●	●	●			Acornsoft
Ring of Time	Traditional adventure game, but more involved than Dracula Island.	●	●	●	●			Kansas
Rocket Raid	Fly a rocket ship through caves.	●	●	●	●	£11.50	£9.95	Acornsoft
Sliding Block Puzzles	Picture Puzzles.	●	●	●	●		£9.95	Acornsoft
Snake	Level after level of difficulty makes this one of the best available.	●	●	●	●			Kansas
Snapper	Snapper eats dots in a maze.	●	●	●	●	£11.50	£9.95	Acornsoft
Snooker	Realistic simulation for two players.	●	●	●	●	£11.50	£9.95	Acornsoft
Space Adventure	A graphic adventure set on a seemingly abandoned ship drifting through space.	●	●	●	●		£7.95	Virgin Games
Space Lab	An involved thinking man's game.	●	●	●	●			Kansas
Sphinx Adventure	Classic adventure.	●	●	●	●	£11.50	£9.95	Acornsoft
Super Invaders	Space Invader type arcade game.	●	●	●	●	£11.50	£9.95	Acornsoft
Trafalgar	Ships of the line doing battle at sea.	●	●	●	●		£7.50	Squirrel
Unoriginal Games	Four basic programs, Pucman, Nightmare Park, Blockade and Rockfall.	●	●	●	●		£2	David McKeran
Zany Kong	Run along girders, climb ladders and leap barrels to rescue the maiden from Kong.	●	●	●	●	£9	£6.50	Solar Soft
Starship Command	Defend command ship from attack.	●	●	●	●	£11.50	£9.95	Acornsoft

## UTILITIES

Append It	Splices any number of basic programs together. Auto renumber etc.	●	●	●	●	£5	£3	Aztec
Beebsynth	Define and save 16 envelopes and use in the keyboard section. Allows you to play tunes.	●	●	●	●	£10.95	£7.95	Clares

Continued from last month

Title	Description	Model A	Model B	Joystick	Keyboard	Price		Supplier
						Disc	Cassette	
Towers	Builds adjacent towers to demonstrate difference between odd/even numbers for very young.	●	●	●	●		£4.85	Bryants
Towns of Britain	Questions on over 40 major towns. Hires map of Britain. Colour and sound.	●	●	●	●	£8.50	£6.50	Aztec
Treasure Hunt	Search a grid and follow clues using the 4 major compass points to find the treasure.	●	●	●	●		£6.90	Kingfisher
Tree of Knowledge	Simple educational database.	●	●	●	●	£11.50	£9.95	Acornsoft
Word Hunt	Primary Language	●	●	●	●	£15.35	£11.90	Acornsoft
Word Sequencing	Primary Language.	●	●	●	●	£15.35	£11.90	Acornsoft
Wordfrog	Program to assist spelling.	●	●	●	●		£7.50	Educated Owl
Prkma	Molecular biology nearest neighbour frequencies.	●	●	●	●			CPE

## BUSINESS

Desk Diary	Address book and planner.	●	●	●	●		£9.95	Acornsoft
Graphs and Charts	Library of routines for graph plotting.	●	●	●	●		£9.95	Acornsoft
Meditor	Tape based word processor for Epson printers with option for 80 column screen.	●	●	●	●		£12	MED

Continued from Part 1

## LANGUAGES

BCPL	Structured programming language comprising ROM, disc manual	●	●	●	●		£99.65	Aztec
Forth	Full implementation to 79 standard with graphics and assembler	●	●	●	●	£19.90	£16.85	Aztec
Lisp	Full interpreter with demonstration program	●	●	●	●	£19.90	£16.85	Aztec

Continued from last month

## GRAPHICS

Creative Graphics	Routines to demonstrate graphics techniques on the BBC Micro	●	●	●	●		£9.95	Acornsoft
Perspective	Any shape drawn produces 3D perspective.	●	●	●	●	£8.50	£6.50	Aztec

Continued from Part 1

## DOMESTIC

Personal Accounts	An ideal personal bookkeeping system.	●	●	●	●			Kansas City
-------------------	---------------------------------------	---	---	---	---	--	--	-------------

Continued from last month



Title	Description	Price		Keyboard	Joystick	Model B	Model A	Supplier
		Disc	Cassette					
Norm	Statistics, generates normally, distributed random numbers.							CPE
Number Balance	Primary Maths.	£15.35	£11.90					Acornsoft
Orgam	Chemistry, identification of organic compounds.							CPE
PG027	Chemistry, generates random problems in naming alkyl derivatives.							CPE
PG035	Chemistry, generates random problems on volumetric analysis.							CPE
Paenam	Chemistry, IVPAC naming of aliphatic organic compounds.							CPE
Peeko Computer	Microprocessor simulation.		£9.95					Acornsoft
Picture Spell	A word/picture recognition program involving spelling and reading.		£5					GED
Punctuation 1 & 2	Covers explanations, examples and tests on all punctuation.		£4.85					Bryants
Q	Queueing theory.							CPE
Road Safety	For young pedestrian or bike users, animated situations.		£4.85					Bryants
Robotic Sums	An arithmetic game for two people involving addition or subtraction at 3 levels.		£4.50					GED
Sentan	Sentence analysis, parts of speech.							CPE
Sentence Sequencing	Primary Language.	£15.35	£11.90					Acornsoft
Sentence Shaker	Unjumble the words to find the sentence.		£4.50					GED
Sentence Starter	Choose correct answer for appropriate space, either language or mathematical.		£9.50					Educated Owl
Space Recognition	Shapes program for the young. Involves matching rectangles and incomplete squares.		£4.50					GED
Shapes Package	Includes shape recognition and rectangular raid		£8					GED
Speed and Light	Primary science.	£15.35	£11.90					Acornsoft
Spelltest	Over 600 Schonnell vocabularies available or create your own lists.		£4.85					Bryants
Stoic	Chemistry, random problems in stoichiometry.							CPE
Storybuilder	For imaginative retelling between 3 fairy tales.		£4.85					Bryants
Submarines	Find the submarines using simple coordinate geometry and the clues.		£4					GED
SuperSpell	9 separate sections of 20 words on each, amended. Hangman type graphics.	£7.50	£5.50					Aztec
Tables	Tests and aids any table to 20. Builds graphical reward or lists table.		£4.85					Bryants
The Garden	Three programs that use superb graphics to help children with colours, spelling and recognition.		£6.95					Clares
Timeman One	Attractive and motivating program to teach children to tell the time.	£10.98	£8.97					Bourne

Title	Description	Price		Keyboard	Joystick	Model B	Model A	Supplier
		Disc	Cassette					
C	Improved CAT program which gives the size of each file address.	£3						Baksoft
Catalogue	Improved version of CAT for discs, giving length and details of space on disc.		£4					Baksoft
Character Formatter	Enables the use of user defined character to be easy.		£3					Beebsoft
DOS Utilities	Formats and verifies 40 or 80 track discs. Allows use of cheaper drives.	£15						Carvells
Data File	The all singing, all dancing data file.							Kansas
Disk	Disc utility to enable 57 files to be used.	£12						Carvells
Enhancer	Allows more than 31 files per disc by creating 2 catalogues.							Carvells
Joystick Utility	Converts non joystick programs to run with joysticks.		£5					Clares
Library Classification	Contains 750 topics, easy to add more, will take over 1000, with average search time of 3 seconds.	£8.50	£6.50					Aztec
Library Dewey	Contains 750 topics. Easy to add more. Will take well over 1,000.	£8.50	£6.50					Aztec
MasterCopier	Copies machine code tapes. Two keys to press.		£6.50					Aztec
R	Program which allows the user to recover a deleted Basic file.	£5						Baksoft
Recover	A utility to recover accidentally erased Basic files from disc.		£6					Baksoft
Replica	Allows most machine code and basic programs to be uploaded to disc.	£9.95						Clares
Terminal Emulator	Enables the user to talk to other computers and mainframes via RS423.	£16.00						Carvells
XT, X	Program system which allows the user to store up to 145 files on each side of each disc.	£6						Baksoft

## EDUCATION

Continued from last month

Algebraic	Four algebraic manipulation and reduction programs.		£9.95					Acornsoft
All Fingers Go	Ultra fast touch typing. Ten lessons from beginners to full keyboard typing. Two cassettes.		£14.95					NEC
Bact	Biology simulation of growth of a culture of bacteria under 3 conditions.							CPE
Business Games	Stock market and management games.		£9.95					Acornsoft
Cat and Mouse	Practice arithmetic at various levels against the clock. Will the mouse reach the cheese?		£6.90					Kingfisher
Chain	Simulation of nuclear decay.							CPE

Title	Description	Model A	Model B	Joystick	Keyboard	Price		Supplier
						Disc	Cassette	
Catchapple	A fun way to practice multiplication tables. Correct answers must be picked from a tree.	●	●	●	●		£6.90	Kingfisher
Charge	Physics / simulation of Millikan's oil drop experiment.	●	●	●	●	£17.25	£13.80	Accornsoft
Chemical Analysis		●	●	●	●	£17.25	£13.80	Accornsoft
Chemical Simulations		●	●	●	●	£17.25	£13.80	Accornsoft
Chords	4 separate sections. Instructs and tests in the use of written and played musical chords.	●	●	●	●	£8.50	£6.50	Aztec
Chroma	Chemistry, chromatography.	●	●	●	●			CPE
Claws	Claw starts travelling once mental arithmetic option chosen and displayed.	●	●	●	●		£4.85	Bryants
Cloze	Interpret the passage and add the missing words.	●	●	●	●		£4.50	GED
Cloze Procedure	Follows Bullock report recommendations, five passages which can have selected words.	●	●	●	●		£4.85	Bryants
Comatch	For pre school children, but loved by adults. Animation and Mode 7 holds their attention.	●	●	●	●		£4.95	Clares
Compass	A directions program starting with up, down, left, right.	●	●	●	●		£4.50	GED
Contf	Continuous flow calorimetry simulation.	●	●	●	●			CPE
Count	Physics study of merits of different counting systems for various isotopes.	●	●	●	●			CPE
Counting	Excellent graphics engage the child's interest whilst learning to count. Number up to 20.	●	●	●	●		£4.95	Clares
Country (SW/SM)	Draws southern counties in colours with main towns or rivers.	●	●	●	●		£4.85	Bryants
Crocodiles	Tame croc can be released to catch odd/even number, wild croc punish.	●	●	●	●		£4.85	Bryants
Crossed Words	5 separate sections, 100 letters in each. Topics are animals, colours, red indians, flight, family.	●	●	●	●	£8.50	£6.50	Aztec
Dataquiz	Utility for creating unlimited multiple choice question, answers and explanations.	●	●	●	●		£4.85	Bryants
Density and Circuit	Primary science.	●	●	●	●	£15.35	£11.90	Accornsoft
Dval	Chemistry, X ray diffraction.	●	●	●	●			CPE
Early Num	Demonstrates and tests on ordinal numbers in words and figures.	●	●	●	●		£4.85	Bryants
European Studies	High res map, 14 countries, 14 towns in each. Lot of questions.	●	●	●	●	£8.50	£6.50	Aztec
Farm	Program to study the effects controlling the management of an arable farm.	●	●	●	●			CPE
Fizz Buzz	Tables reaction game for two people.	●	●	●	●		£4.50	Bourne
Forder	Investigation changes in concentration of a reactant when it undergoes a first order reaction.	●	●	●	●			CPE

Title	Description	Model A	Model B	Joystick	Keyboard	Price		Supplier
						Disc	Cassette	
Fraction Chase	A game for 2 people. Answer the question correctly, shake the dice, then move around the board.	●	●	●	●		£4	GED
GCE Maths (O)	Revision Tape 2. Covers questions, explanations on standard form, significant figures, geometry.	●	●	●	●		£9.50	Bryants
GCE Maths (O)	Revision Tape 1. Covers questions, explanations on typical exam syllabuses.	●	●	●	●		£9.50	Bryants
German Sentence Practice	First program, a series of pictures to teach phrases. Second program cloze type phrases learnt.	●	●	●	●		£9.50	Educated Owl
Graphs (Arit)	Demonstrates histograms, polygonal and pie graphs which can be reused.	●	●	●	●		£4.85	Bryants
Happy Numbers	Full colour graphics, number recognition and counting. For 4/6 year olds.	●	●	●	●	£10.98	£8.97	Bourne
Intro	A logo like language that uses turtle graphics to introduce programming concepts and techniques.	●	●	●	●		£7.95	Clares
Jars		●	●	●	●	£15.35	£11.90	Accornsoft
Jumbled Letter	Unjumble the letters faster than your opponent.	●	●	●	●		£4	GED
Jumbles	Simple (junior level) sentences need reassembling from random order boxes.	●	●	●	●		£4.85	Bryants
Junior Maths	5 levels of difficulty, 3 separate sections. Correctly set out one under the other.	●	●	●	●	£5	£3	Aztec
La Princesse	All instructions and responses in French. Very involved maze with graphics and sound.	●	●	●	●	£8.50	£6.50	Aztec
Look It Up	Provides practice in placing words in alphabetical order. Two levels offered.	●	●	●	●		£4.50	GED
Malaria	Simulation of attack, phase treatment of a malaria epidemic.	●	●	●	●			CPE
Mark Book	Teachers Mark Book program for 40 pupils.	●	●	●	●	£18	£15	Beebsoft
Massdef	Chemistry, compares relative stability of different isotopes of the same element.	●	●	●	●			CPE
Matching	Four programs covering word, shapes, patterns, numbers. Ideal for pre school and infants.	●	●	●	●		£5.95	Clares
Maths Man	An arithmetic game for one, involves addition, subtraction and multiplication, at 3 levels.	●	●	●	●		£4	GED
Microtype	The recognised standard in typing tutors.	●	●	●	●			Kansas
Signs	Primary Maths.	●	●	●	●	£15.35	£11.90	Accornsoft
Money Box	Shopkeepers arithmetic, multi or subtraction, add on option.	●	●	●	●		£4.85	Bryants
Monster Maze	Have fun finding the way out of the maze and practice arithmetic at the same time.	●	●	●	●		£6.90	Kingfisher
Morse Code Fun	Audio and written morse. Lots of key words.	●	●	●	●	£5	£3	Aztec
Musical Numbers	Continuous music and generated matching graphics with ordinal numbers (1 to 10).	●	●	●	●		£4.85	Bryants

# The garden of unearthly frights..

With apologies to H. Bosch

ONCE upon a time there was a garden, one of many levels connected by steep and hazardous ladders. In this high and airless garden grew wild and mysterious fruit, tempting and tasty.

Yet many perils awaited those who sought it. Some perished from lack of oxygen. Others died in terror as they found that the object of their desires — the fruit they'd sought so long — attacked them viciously.

Yet still people came, perhaps driven mad by craving for the deadly fruit, perhaps just to test their foolish courage. Still they sought to reach the highest levels ... and few survived.

Are you brave enough to scale the ladders and survive the fruity encounter? Your only chance is to dig holes through the levels and trick the little devils into falling through. Instructions are given in the game, but first a few hints:

- Don't stay in the same place too long.
- Dig holes fast and deep and hit the fruits before they get time to crawl out.
- Watch out for the ultimate horror — an overgrown mango, which appears at the higher skill levels. It is deadly. The only way you can beat it is to drop it through all five levels.

Oh yes, you've got three lives. You'll need them.



# Fruities

## From Page 59

### PROCEDURES

**PROCinit:** Dimensions arrays – sets high score, sets up user defined characters sets up envelopes.

**PROCheader:** Sets up title screen header.

**PROctitles:** Sets up display of control keys.

**PROCinstruct:** Displays scenario.

**PROCmove:** Animates man.

**PROC man move:** Checks keyboard and takes appropriate action, checks if man is over a hole or if man is over a trapped Fruity.

**PROCdig:** Checks which direction

man is facing and selects the correct dig procedure.

**PROCdig\_right:** Dig a hole to the right of current position. Or fill in hole if Fruity is trapped there.

**PROckill\_right:** Decides which Fruity has been hit.

**PROCdig\_left:** As for PROCdig\_right.

**PROckill\_left:** As for PROCkill\_right.

**PROCfall:** Drops the man through a hole and checks that he has not dropped on a Fruity.

**PROCdead:** Subtracts one man. Displays headstone. If no lives remaining – PROCend. Get ready for next sheet.



**PROCend:** Displays end message.

**PROCoxygen:** Calculates and displays current oxygen level.

**PROCaliens:** Calculates new Fruity positions. Checks if they fall into hole or fills partially dug hole.

**PROclevel:** Decides position of man in relation to Fruities and sets appropriate Y vector (to move them up or down).

**PROCamove:** Animates each Fruity.

**PROcalfall:** Sets up falling Fruity and fills holes as it passes through them. Decides whether or not Fruity survives.

**PROCsplat:** Kills Fruity and displays intermediate score for a few seconds.

**PROccrawl\_out:** Makes Fruity jump out of hole and fills hole in.

**PROcdrop:** Drops Fruity into hole, shakes it, and checks for time limit before it crawls out.

**PROcscreen:** Sets up original Mode 2 display.

**PROcsheet:** Sets initial values at beginning of each new sheet and determines new logical colour of ladders.

**PROcbricks:** Draws the bricks.

**PROcladders:** Decides where to put the ladders.

**PROcladd:** Draws the ladders.

**PROcposition:** Decides the starting positions and vectors of all three aliens.

**PROcerror:** Traps escape key. Resets editing keys and keyboard repeat delay if an error is encountered.

### MAJOR VARIABLES

A% } B% } C% } D% }	Used for point testing of brickwork.
F%	Distance required to kill a falling Fruity.
H%	Displayed colour of Fruities.
I%	Score to date while Fruity is falling.
K%	Ascii value of last key pressed.
N%	Used as an array pointer to indicate Fruity co-ordinates being accessed (also used as a loop counter).
O%	Amount of oxygen remaining.
Q%	Number of Fruities on present sheet.
R%	Logical colour of ladders.
V%	See AX% (N%)
W%	See AY% (N%)
X%	X position of man.
Y%	Y position of man.
Z%	Used as a pointer of the man's Y position.
AX% (N%)	Fruity (N%)'s X position.
AY% (N%)	Fruity (N%)'s Y position.
MX% (N%)	Fruity (N%)'s X vector (direction and speed of travel).
MY% (N%)	Fruity (N%)'s Y vector (direction and speed of travel).
NCAR%	Man's new display character.
OCAR%	Man's old display character.
OLDAX% (N%)	Fruity (N%)'s old X position.
OLDAY% (N%)	Fruity (N%)'s old Y position.
MAN%	Number of lives remaining.

YOU score points by trapping the aliens, or "Fruities", in holes and filling them in before they crawl out.

You will meet:

Strawberry	- Red	- 100 Points	- Level 1
Gooseberry	- Green	- 200 Points	- Level 2
Banana	- Yellow	- 300 Points	- Level 3
Bilberry	- Purple	- 400 Points	- Level 4
Mango	- Cyan	- 500 Points	- Level 5

As you clear each sheet more Fruities will appear until you kill three of them, after which you return to one.

This is of a tougher variety. Dropping a Fruity through more levels scores more points.

**Listing starts  
on Page 93**

# If you can buy it cheaper we'll refund the difference.\*

This month's offer is another winner — a consignment of 14" R.G.B. colour monitors manufactured by J.V.C. — at prices never seen before in the U.K. Suitable for use with BBC Micro,

Lynx, Oric, Apple II, Apple III and IBM etc.

It's safe to put a cheque in the post today. Because, if you find someone who's cheaper, we'll refund the difference.

## RGB MEDIUM RES £199.00

Resolution, 370 x 235, Pixels.  
Display, 80 characters x 25 lines. Slot Pitch 63mm.  
Input, Video — RGB Analogue with TTL input.  
SYNC — Separate SYNC on RGB. Features, On/Off switch with pilot light. Brightness control.  
Power 220/240V 50/60HZ.

## RGB HIGH RES £299.00

Resolution, 580 x 235 Pixels.  
Display, 80 characters x 25 lines. Slot pitch 41mm.  
Input, Video — RGB Analogue with TTL input  
SYNC — Separate SYNC ON RGB.  
Features, On/Off switch with pilot light.  
Brightness control. Power, 220/240V 50/60HZ

## IBM COMPATIBLE £349.00

Spec as above with IBM Interface.

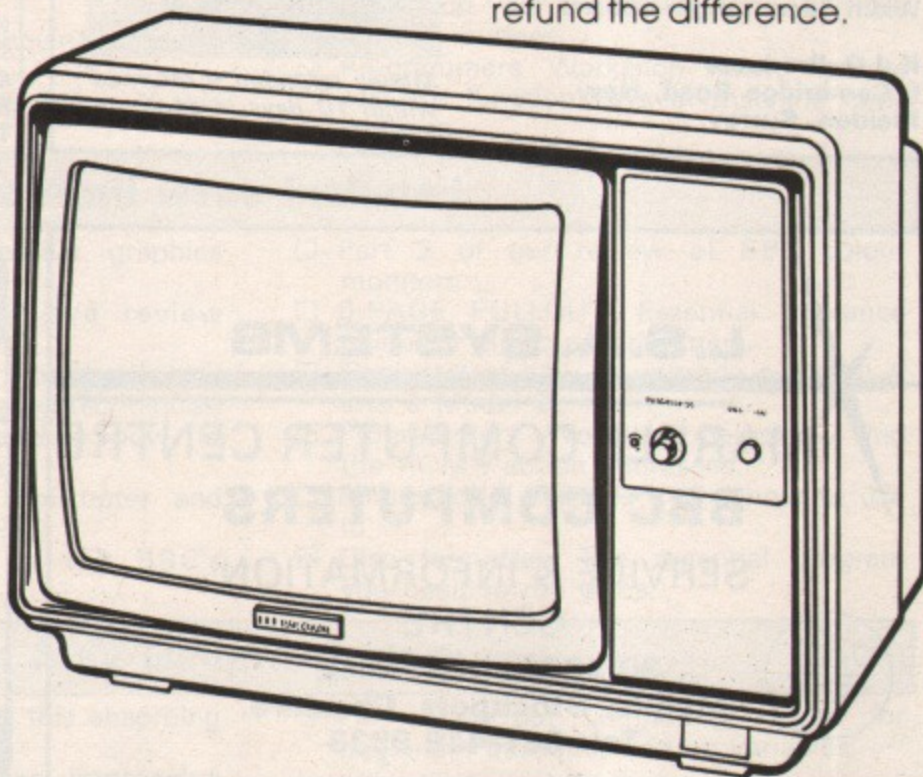

## TEAC DISC DRIVES

TEAC 55F — 5¼" D/S 80 track. Formatted single density 400K Double density 800K. **only £229.00**

Case to hold two drives with power supply and blanking plate. **only £39.95**

Ribbon lead to connect one drive to BBC. **£12.00**

Dual Ribbon lead **£15.00**

Power lead to connect one drive to BBC. **£5.00**

Ideal for use with BBC Micro. Full warranty. Low power consumption. Slimline latest technology. Switchable 40/80 track.

## CANON DISC DRIVES

MDD 6106 5¼" S/S 40 track. Formatted single density 100K. Double density 200K. **£129.95**

Case to hold single drive. **£9.95**

Leads as with TEAC DRIVES

## THE ORGANIZER DESK

At last a desk designed for the personal user. Full size desk. Suitable for all leading micros. On castors. Teak finish. DEALER ENQUIRIES INVITED. **only £49.50**

## DOGFIGHT

If you have a BBC 32K with any O.S. become a flying ace with our wonderful new game Dogfight. An exciting 2 player game with 8 levels of difficulty. **only £8.65**

## 12" GREEN SCREEN MONITOR

One year warranty, ex stock delivery, 18 MHZ, Phono connector. Limited quantity. **only £69.95**

Lead to connect to BBC **£5.95**

## NASHUA FLOPPY DISCS

Minis		8" Discs	
S/S S/D	£16.95 for 10	S/S S/D	£17.95 for 10
S/S D/D	£19.95 for 10	S/S D/D	£23.95 for 10
D/S D/D	£22.95 for 10	D/S D/D	£24.95 for 10
S/S 80 Track	£24.95 for 10		
D/S 80 Track	£26.95 for 10		

With full 5 year warranty. All mini discs have hub rings and a FREE plastic library case.

## 8" DISC DRIVES SHUGART COMPATIBLE

FD514 S/S Dual density. Formatted 600K Byte **only £149.00**

FD650 D/S Dual density. Formatted 1.2M Byte **only £199.50**

Pertec 90 day warranty.

Case to hold 2 drives — complete with power supply and fan. **only £99.95**

## VIEW DATA TERMINALS

Prestel, Built in modem. G.P.O. approved, slimline design. **only £199.00**

\*Our price pledge only applies to the JVC monitor

To order: Add carriage at the following rates: — Discs 85p. Other goods £7.00. Add VAT at 15% to total and send your order to:

## OPUS SUPPLIES

158, Camberwell Road, London SE5 0EE  
Tel: 01-701-8668 (3 lines) 01-703-6155/6/7



Government and educational orders welcome.



## BBC MICROCOMPUTER STATION

### Features:-

Cable Clips, Dais with storage,  
Castors, Cable Tidy, White  
Melamine.

**£49.95**

All inclusive

Teak or Mahogany Veneer  
£10 extra.  
4 Way Mains Socket + Cable  
£12 extra.

Dimensions:  
Width 60cm Length 105cm

**K.J.G. Products**  
6 Cambridge Road, New  
Malden, Surrey.

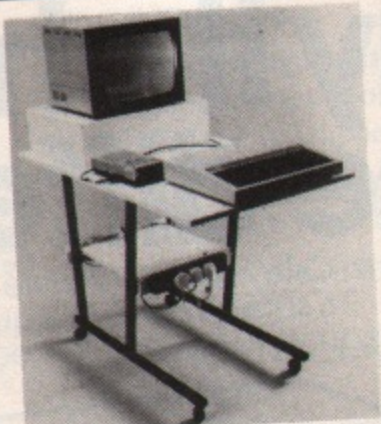

Money refunded if returned  
within 10 days in good  
condition.

ALL IN  
STOCK

## S.P. ELECTRONICS

BBC  
SPECIALISTS

BBC Model B 1.2 O.S .....	£399
Upgrade Kits A to B .....	£60
Disc Operating System .....	£109
Disc Drives .....	from £228
Cassette Recorders .....	£18.90
G3WHO RTTY PROGRAM .....	£7.50
Circuit boards for RTTY decoder (inc. instructions) .....	£6.30
Computer Dust Covers .....	£3.00
CP80 and Star 510 Printers .....	£343.00
Joysticks (pair) .....	£13.00
Printer Cable (Centronics) .....	£12.90
VIEW Word Processor .....	£59.00
WORDWISE Word Processor .....	£39.00

Wide selection of software, books, leads, plugs, etc.

SAE for full list. All available Mail Order

**48 Linby Road, Hucknall,  
Notts. NG15 7TS.  
Tel: 0602 640377**



(all prices include VAT)

All prices apply  
while stocks last.

Carriage  
extra

## L.S.A. SYSTEMS

### MARPLE COMPUTER CENTRE BBC COMPUTERS SERVICE & INFORMATION CENTRE

30/32 Market Street,  
Marple, Stockport, Cheshire.  
Tel: 061-449 9933

Also Apple, Torch, Altos business systems.

## NOTE INVADERS

NEW

Three superb programs for the BBC 'B', Spectrum 48k or VIC 20.  
Never has learning to read music been so much fun and so easy - at  
school or in the home ...

Dereck Riddell - music specialist and BBC expert - has produced three  
programs which are just what music teachers have told us over and  
over again they want.

STAFF1 and STAFF2 teach both bass and treble note-recognition with  
full colour and sound.

INVADERS gives a games format opportunity to increase  
music-reading speed. Name the notes before they destroy your base!

All 3 programs for **£9.25** (all inclusive)

Trade and export enquiries welcome. Orders/enquiries (SAE) to:  
**CHALKSOFT LTD., (BMU8)**  
Lowmoor Cottage, Tonedale, Wellington, Somerset TA21 0AL.

MP

## B.B.C. MICRO SOFTWARE

"FIRIENWOOD"  
£6.50 + VAT

Journey on a quest for the Golden Bird of Paradise  
in this adventure game. Travel through caverns and  
a forest in a land of monsters and magic where  
death waits around every corner.

"SURVIVOR"  
£6.50 + VAT

You are shipwrecked on a tropical island in this  
unusual adventure game. Can you survive and  
escape back to civilisation, or will you end up in  
someones cooking pot. Try it if you dare!!! Written  
in machine code.

"SWAMP  
MONSTERS"  
£6.50 + VAT

A fantastic high speed game in machine code with  
full colour and sound. Can be played with or without  
joysticks. Guide your robot through an alien swamp  
and try to destroy the monsters that inhabit it.  
(Model B or 32K Model A + User Port).

"SPACEGUARD"  
£6.50 + VAT

Your ship is trapped by aliens in this great space  
game. Your only chance is to destroy them whilst  
avoiding the mines they are laying. Can be played  
with or without joysticks. Mode 2 graphics and  
sound. (Model B or 32K Model A + User Port).

"INVADERS"  
£6.50 + VAT

A fast moving space game, compiled in machine  
code. It utilises mode 2 colour graphics and sound.

All programs require 32K and run on all operating systems. Disc  
versions now available, ask for details. Prices include postage within  
U.K. Send S.A.E. for full range of programs and price list or ask your  
local dealer.

Trade enquiries welcome.

ALL PRICES INCLUDE POSTAGE. CHEQUES  
AND POSTAL ORDERS PAYABLE TO: M.P. SOFTWARE.

MP

## SOFTWARE & SERVICES

DEPT. BM, 165 Spital Road,  
Bromborough, Merseyside L62 2AE.  
Telephone: 051-334 3472

## EXTENDED COLOUR-FILL GRAPHICS E.C.F.G. GIVES YOU A CHOICE OF !! 4 BILLION + !! SHADES FOR TRIANGLE FILLING IN BBC MODES 0,1,2,4 & 5

- \* PLOT 81 and 85 commands for triangle-filling  
have been adapted to use the ECFG fill-shade  
currently selected by new ECFG user-friendly  
commands. GCOL is still used for line colour.
- \* Easy choice of 17, 289 & 6561 subset colours  
between those normally available in 2, 4 & 16  
colour MODEs. Further options include colours,  
angles, spacings & widths of cross-hatch etc.
- \* ECFG commands can be used in BASIC, typed  
from the keyboard, accessed in Assembler, or  
in future BBC Micro languages. ECFG is MOS-  
adaptive, and proven with versions 0.1 to 1.2
- \* Bootstrap from cassette rapidly builds an ECFG  
module at a RAM address pre-defined by PAGE,  
which is then automatically increased 512 bytes  
to allow immediate LOADING of programs etc.

Price : £10 inc : Mail Order only

**GAELSETT Software**

44 EXETER CLOSE, STEVENAGE, HERTS. SG1 4PW.  
(Tel. Stevenage 51224)

# Make sure your collection is complete!

## Articles in the March issue included:



- Part 1 of our series on computing for beginners introduces the keyboard.
- How to build your own games paddle.
- Review of the Alphabeta word processor.
- Part 1 of our easy-to-understand guide to text colours and graphics.
- Part 1 of our introduction to the BBC operating system.
- How to avoid those annoying cassette loading problems.
- DEATHWATCH! Complete listing of this arcade game.
- How to upgrade a Model A to B at half the shop price.
- Create your own micro portrait gallery with our "Shapes" program.
- Play Bingo and learn about random numbers.
- Part 1 of our evaluation of colour monitors for the BBC Micro.
- Speed up your processing time with our sorting routines.
- Programmers' Workshop shows how to test for function keys in machine code routines.

## Articles in the April issue included:



- How to produce impressive graphics using Teletext Mode 7.
- Having listing trouble? We review common copying errors.
- Part 2 of computing for beginners discusses simple programming techniques.
- Our graphics course teaches how to draw multi-coloured lines.
- KING KONG! Fly your helicopter and rescue maidens in distress.
- Part 2 of our guide to the BBC's operating system.
- Part 2 of our review of BBC colour monitors.
- 8-PAGE PULLOUT: Essential reference guide for Basic programmers.
- Final part of how to upgrade a Model A into a Model B.
- Programmers' Workshop helps you find the ROM's action addresses.
- Binary code: What is it and how to use it.
- Disc formatter: The essential program you need to run discs.

## Articles in the May issue included:



- Pelmanism: Full listing for this absorbing memory game.
- Mode 7 animation gives impressive graphics with low memory costs.
- Simple techniques to generate vertical or even inverse text.
- Our graphics course continues colourfully with triangles and rectangles.
- Build yourself a joystick: Part 3 of the Beeb Body Building Course.
- Two whole articles devoted to investigating the Osbyte routine.
- Part 3 of our computing course for beginners introduces string variables.
- AIR STRIKE! A fast and furious arcade game.
- Anagrams: A simple word game for the whole family.
- Part 1 of a series exploring structured programming.
- How to make full use of the BBC Micro's editing function.

## Articles in the June issue included:



- Part 2 of our series on editing on the BBC Micro looks at LIST and LISTO.
- We sound out the BBC speechchip.
- Part 2 of our series on structured programming.
- Our beginners' series examines the use of the INPUT statement.
- Cassette Capers - more ideas to solve those perennial cassette problems.
- 8-PAGE PULLOUT: Part 1 of our Guide to Software for the BBC Micro.
- Build yourself a graphic digitiser with the latest Beeb Body Building exercise.
- We uncover the hidden \*FX calls, explain indirection operators and give a single key memory display program.
- Beyond Z - an easy to follow introduction to User Defined Characters.
- SPACE PILOT! Three games in one in this all action galactic blockbuster!
- Graphics: We investigate text and graphic windows.
- Nomsim: an intriguing simulation of life on the African Savannas.
- We present a colourful guide to bringing your User Defined Characters to life.

## Articles in the July issue included:



- TEN PINS! An enthralling simulation of ten pin bowling.
- The PRINT statement revealed - an exposé of its intricacies for beginners.
- Graphics: Stunning sunburst effects with simple graphics techniques.
- Procedures: The latest instalment of our structured programming series.
- Using the User Port to maximum effect: The Beeb Body Building Course explains how.
- SPACE PODS! A compelling space adventure. Can you halt the aliens?
- Wordwise: An in depth review of the word processing chip for the BBC Micro.
- Learning to like loops in the latest article in our beginners' series.
- A review of Epson's latest printer, the FX 80.
- How to turn your BBC Micro into a sophisticated design tool.
- Hexadecimal highlights in the latest instalment of Bits and Bytes.
- Programmers' Workshop: How to edit with impunity and fix that break key.

Back numbers still available at £1.25 **ORDER FORM ON PAGE 73**

*incl. p&p*

# The **BBC** Microcomputer Specialists

GUILDFORD COMPUTER CENTRE offers a complete range of Computers for Home, Business and Educational applications.

Large stock of additional equipment available includes:- Printers, Hard/Floppy Disc drives, Monitors etc., for most makes.

An extensive range of Business software (Accounts, Stock, Payroll, Word Processing etc.).

Drop in for a frank discussion and expert advice on your requirements or arrange a demonstration. We give a full and expert backup to ALL our sales.

Stockists of:- BBC/Acorn, Torch, Oric, Olivetti, Hitachi, TRS-80, Commodore, Dragon, Sharp, Sirius, Osborne, IBM, Newbrain, Epson, Seikosha, Cumana, etc.

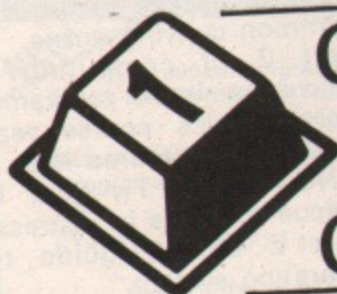

**GUILDFORD  
COMPUTER  
C·E·N·T·R·E**

1 The Quadrant, Bridge Street,  
Guildford, Surrey GU1 4SG  
Telephone (0483) 578848

**commodore**  
**olivetti**



**HITACHI**

**BBC TRS-80®**

# 3D COMPUTERS

THE **ACORN**  
SPECIALISTS



## **BBC** Micros Ex-stock

Appointed Distributor  
for the BBC Buggy

### PERIPHERALS

PRINTER,  
COLOUR MONITOR  
DISC DRIVE  
TORCH Z80 DISC  
CASSETTE RECORDER  
CUMANA DISC DRIVES

### SOFTWARE

ACORNSOFT  
BBC SOFT  
PROGRAM POWER  
BUG-BYTE  
SIMON HESSEL

### ADD-ONS

JOYSTICK  
LIGHT PEN  
GRAPHICS TABLET  
TELETEXT  
Z80 PROCESSOR  
6502 PROCESSOR  
MEMORY UPGRADE  
DISC INTERFACE

### BOOKS

30 HOUR BASIC  
BBC BASIC  
BBC MICRO REVEALED  
LET YOUR BBC TEACH  
LEARNING TO USE BBC  
ASSEMBLY LANGUAGE

**TOLWORTH:**  
230 Tolworth Rise South,  
Tolworth, Surbiton,  
Surrey KT5 9NB  
Tel: 01 337 4317  
**SUTTON:**  
30 Station Road,  
Belmont, Sutton,  
Surrey SM2 6BS.  
Tel: 01 642 2534

**EALING:**  
114 Gunnersbury Avenue,  
Ealing, London W5 4HB  
Tel: 01 992 5855  
**RICKMANSWORTH:**  
Greystone Works,  
The Green, Croxley Green,  
Rickmansworth,  
Herts WD3 3AJ.  
Tel: (0923) 779250

**MILTON KEYNES:**  
Unit 1, Heathfield,  
Stacey Bushes, Milton  
Keynes,  
MK12 6HP  
Tel: (0908) 317832  
**NEWBURY:**  
26 Stanley Road,  
Newbury, Berks RG14 7PB  
Tel: (0635) 30047

Easy parking  
at all our

Closed Mondays.



# GRUNDIG KINGSLEY

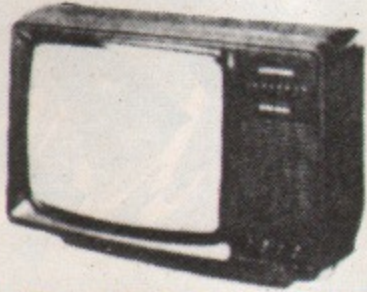

## R.G.B. MONITOR/TV (GRUNDIG APPROVED)

As supplied to Education Authorities Specification

R.G.B. inputs (Analogue and Digital Levels) all models  
1 Volt P.P. composite video (remote model only)  
Teletext decoder available to plug into chassis. (remote  
model only). Remote control of computer via monitor  
(remote model only). Sound input gives access to audio  
amp all models. Instantly switches back to TV.

12" MONOCHROME MONITOR/TV	£95 + VAT
14" COLOUR MONITOR/TV	£227 + VAT
16" COLOUR MONITOR/TV	£255 + VAT
16" COLOUR MONITOR/TV REMOTE	£295 + VAT
20" COLOUR MONITOR/TV REMOTE	£315 + VAT
22" COLOUR MONITOR/TV REMOTE	£340 + VAT
26" COLOUR MONITOR/TV REMOTE	£380 + VAT
PLUG IN TELETXT MODULE	£75 + VAT
CONNECTING LEAD	£5 + VAT
CARRIAGE AND INSURANCE	£9.50
4 YEAR GUARANTEE	£29.60

### KINGSLEY

40-42, Shields Road, Newcastle-upon-Tyne,  
NE6 1DR. Tel: (0632) 650653



## BBC 32K 747 FLIGHT SIMULATOR & BRIEFING

A full blown, pilot written simulation (writer of the famous Atom 747) real time instrument and visual display, 3D runway view (Heathrow or Gatwick), large dials, moving pointers plus digital readout. Demonstration approach and landing. Full, separate briefing program. Area chart, notes and flight plan. Fantastic!



A new concept, a new classic . . .

### Wolfpack III

BBC 32K, all operating systems

Combat briefing and program

"Sometimes your first warning is a lancing disruptor beam striking from beyond—sometimes they materialise close at hand. You are either quick or dead!" "A think, zap and think again game!"

True in-space cumulative motion, amazing full colour Starfield graphics & sound. Multiple ship control, each ship has its own mission and destiny, 4 types of enemy, meteor strikes. Good strategy rewarded by energy & promotion. Poor combat rewarded by death! (but rescue/refuel possible). Rotating base station, intergalactic warp.

KREMLIN multi level maze escape with Gremlins/bomb/3D graphics and sound/map/compass/quiet explore option!

HARMONY: infinite, saveable, 3D patterns of colour and sound, menu driven.

WORD PERFECT friendly and versatile, full facility 40/80 column word processor (add £4 for disc version)

DEALERS ONLY PLEASE PHONE (0903) 206076 ROYALTIES DOC PAYS THE BEST FOR THE BEST

Orders to: Doctor Soft, 258 Coneygree  
Rd., Peterborough PE2 8LR  
NO extras all prices fully inclusive

• Special offer £1 off  
for 2 items, £2 off  
for 3 items, etc

..... copies of	747 @ £7.95	Name.....
..... copies of	Wolfpack £7.95	Address.....
..... copies of	Kremlin £6.95	.....
..... copies of	Harmony £6.95	.....
..... copies of	Word Perfect £9.95	.....
	TOTAL £	.....



## DOCTOR SOFT

ADVANCED SOFTWARE

# BBC SOFTWARE

Quality Software produced by professionals and used in hundreds of schools throughout Great Britain.

**FUN WITH WORDS** B £8.00  
Start your fun with alphabet puzzles in ALPHA. Continue your play as you learn about VOWELS, know the difference between THERE and THEIR and have games with SUFFIXES. After working so hard reward yourself with games of HANGMAN. Learning should be fun. The tape includes ALPHA,VOWELS,THERE?,SUFFIXES and HANGMAN.

**EDUCATIONAL - 1** A or B £8.00  
Hours of fun and learning for children aged 5 to 9 years. Animated graphics will encourage children to enjoy maths, spelling and telling the time. The tape includes MATH1, MATH2, CUBECOUNT, SHAPES, SPELL and CLOCK.

**EDUCATIONAL - 2** A or B £8.00  
Although similar to Educational - 1 this tape is more advanced and aimed at 7 to 12 year olds. The tape includes MATH1, MATH2, AREA, MEMORY (Model B only), CUBECOUNT and SPELL.

**GAMES OF LOGIC & CUNNING** A/B £8.00  
For children and adults alike. The tape includes AUCTION, FLIP, REVERSE, TELEPATHY and HEXA15 (Model B only).

**SUPERLIFE** B £6.90  
Fast (machine code) version of a popular 'Game of Life' in a large universe.

**KATAKOMBS** B £9.20  
Are you cunning enough to discover and seize the treasure in the Katakombs AND return alive? What and where are your enemies? Can you outwit them? Yes? Then your adventure will take you through unending forests, besides tumbling streams, over lonely plains to desolate ruins and finally underground to the tortuous Katakombs. Be prepared for anything!

**UTILITIES** A/B £8.00  
Behind the mundane title lies an assortment of useful procedures and functions which can save you hours/days of programming effort: date conversion, input and validation routines, graphic routines (cube, rectangle, etc), sorts, search and many more.

\*\*\* SPECIAL OFFER \*\*\*\* Any 3 cassettes for £20.00  
Add 50p p/p per order. Please state your model.  
DISCS - TORCH Z80 pack - 800K, second processor with 64K RAM, CP/M\* compatible operating system plus system software £890 incl. of VAT

Delivery free within 30m radius otherwise £10 delivery charge.  
Cheque/P.O. to GOLEM LTD, Dept B 77 Qualitas, Bracknell,  
Berks, RG12 4QG. Telephone: (0344) 50720

## A NEW SERVICE FOR BBC MICRO OWNERS

You can now get printed listings of their programs, without having to buy an expensive printer.

A listing is essential for development and de-bugging of programs and, for would-be contributors, most magazines prefer to receive a listing taken from a working program.

Example Charges:

PROGRAM LISTING	
(Maximum Block Count - &20)	£1.95
Excess charge (over &20 blocks)	20p per 9 blocks
EXTRA PROGRAMS (on same tape)	£1.00
300 baud Tapes	50% extra
HIGH RES. SCREEN DUMP	
(needs line added to program)	50p
• WORDWISE DOCUMENT PRINTING SERVICE	

Details on request

BEEBPRINT will despatch a high quality printed listing, from cassettes only, by return of post. All material will be handled in strict confidence and tapes returned with the listings.

### BEEBPRINT SOFTWARE

GAMES 1: SQUIRM and FLATTEN MANHATTAN - A Snake/Worm type game and a Bomb Run game on one tape £3.50 (32K)  
GAMES 2: CODE-KRACKER and KRACK-WORD - Two "Mastermind" style logic games £3.50 (32K)

All prices include post and packing

An S.A.E. for full details and a sample listing.

## beebprint

SPECIALIST COMPUTER SERVICES

Dept. MU8  
19, Orchard Way, Hurstpierpoint,  
Hassocks, W. Sussex BN6 9UB.

LOGICAL and bitwise operators in BBC Basic, according to the BBC Micro User Guide, are equivalent (Page 205). Unfortunately, therefore, the operators AND, OR and EOR need to be bitwise operators and cannot always be used as logical ones.

Consider the example in Program 1 (the THEN in line 60 may be omitted). If both conditions in line 60 are true, that is if SIZE is 9 and if WEIGHT is 9, then of course, QUIT is printed, and if one or both of them is/are false the QUIT is not printed.

Here, and in the following examples, printing QUIT serves merely as an acknowledgement – the program is not actually exited. The process, bitwise, used by BBC Basic is first to evaluate both conditions to either TRUE or FALSE separately.

Since the only combination of two of the two logical values TRUE and FALSE which when ANDed can be resolved to TRUE is TRUE AND TRUE, "QUIT" will be printed only if both conditions are true (some understanding of Boolean algebra or logic is required here).

The effect of line 70, incidentally, is to cause the REPEAT...UNTIL loop to repeat indefinitely, so the program has to be exited by pressing Escape.

UNTIL 0 (nought) could have been used instead of UNTIL FALSE, since FALSE in BBC Basic has the numerical value 0. (TRUE has the numerical value -1.)

However, if the first condition in line 60 (SIZE=9) were *not* true, then regardless of the result of the second condition (WEIGHT=9), the two conditions together could not give TRUE (because as explained, using AND, only TRUE AND TRUE gives TRUE). This should be clear to anyone able to understand simple logic – bitwise or otherwise.

Yet the second condition is always tested. This can easily be shown by deleting line 50 and running the program again.

Irrespective of whether SIZE is equal to 9, the error message "No such variable at line 60" appears and refers to the variable WEIGHT.

This shows that whatever the result of the first condition, an attempt is made to test the second, which is unnecessary when the result of the first is FALSE (such as when SIZE does not equal 9). Hence the operator AND is not a true logical one.

So what? WEIGHT should be defined anyway, and it doesn't matter whether the second condition is tested. Quite so in this case, but suppose the second condition takes the form of a

```
10 REM *** PROGRAM I ***
20 MODE 7
30 REPEAT
40 INPUT "SIZE ", SIZE
50 INPUT "WEIGHT ", WEIGHT
60 IF SIZE=9 AND WEIGHT=9 THEN PRINT
  "** QUIT **"
70 UNTIL FALSE
```

```
10 REM *** PROGRAM II ***
20 MODE 7
30 REPEAT
40 INPUT "SIZE ", SIZE
60 IF SIZE=9 AND FNYESNO("WANT TO QUIT") THEN PRINT "** QUIT **"
70 UNTIL FALSE
```

```
10 REM *** PROGRAM III ***
20 MODE 7
30 REPEAT
40 INPUT "SIZE ", SIZE
60 IF SIZE=9 THEN IF FNYESNO("WANT TO QUIT") THEN PRINT "** QUIT **"
70 UNTIL FALSE
```

call to a function which GETs a response from the user, as in the program in Program II.

The function definition, which should also be typed in, is given in Program VIII and some explanatory notes follow later. (Note that only lines 10, 60 and 100 to 200 need be typed to

# LOGICAL OPERATORS

## on the BBC Micro

By ALLEN HARDY

amend the existing code.)

Understanding that AND is a logical operator, you may think that the function will be called only when the first condition is true, line 60 being exited when the first condition is found to be false.

Unfortunately, as explained, this is not the case – the function is always called. But unless there is an ELSE clause, replacing AND in line 60 with THEN IF (or just IF since the THEN is optional) will produce the desired effect. See Program III, which differs from Program II in only lines 10 and 60.

This, as you would expect, does cause the remainder of line 60 to be skipped (at least as far as any ELSE clause) if the first condition is false. That is, you are asked "Want to quit?" only when SIZE=9. (An ELSE clause may follow, but due to BBC Basic's IF...THEN...ELSE syntax, it may not be matched with the intended IF.)

This, then, provides us with one solution to unnecessary testing of conditions in an IF statement with any number of conditions and using the operator AND.

Thus, in general,

```
IF (testable condition 1) AND
(testable condition 2) AND ...
(testable condition n) THEN
(action)
```

may be recoded:

```
IF (testable condition 1) THEN IF
```

# “*practically speaking...*”

**Machine:**  
BBC Model B

**Programs:**

**DFM Database**

Fully User-definable  
Up to 15 fields per Record  
Search & Sort on any Field  
Select/View/Print/Calculate  
Report Generator

**DFM Mail Labels**

Reads Database Files  
Resort/Select to User's specification

**DFM Wordflow** (coming soon £19.50)

Word processor to link with Database

**Catalog**

Library Filing System  
36 Element Records  
Cross-referencing  
Search/Sort/View/Print

**Available Soon:**

**Invostat**

Invoice and Statement Generator  
Defineable Formats  
Look-up Tables  
Auto-calculate including VAT  
Sales Analysis and Listings

**Transact**

Process: Sales/Purchases/Bank/Petty Cash  
Full Transactional Analysis  
Automatic Double-Entry Checking at Input  
Auto-Posting of Nominal Accounts  
Trial Balance

**Notes:**

Prices include P&P and VAT  
All programs are disk and tape compatible,  
easy to use and supplied with documentation.  
Software Support & Newsletters direct to  
registered users.

Please write or phone for further information.  
24 hour Access/Visa Barclaycard Hotline

01-289 6904

Please supply for : Disc drive type .....			
: Tape (tick) <input type="checkbox"/>			
Copies	Programs	Price	Value
	<b>DFM Database</b>	<b>£24.00</b>	
	<b>DFM Mail Labels</b>	<b>£10.00</b>	
	<b>Catalog</b>	<b>£19.50</b>	
I enclose a cheque/PO to the value of			£
Name: .....			
Address: .....			
.....			
m/u Please send me details of your programs (tick) <input type="checkbox"/>			

# “*dialog...*”

**Dialog Software**  
19 Short's Gardens, London WC2H 9AT

## From Page 66

(testable condition 2) THEN  
IF... (testable condition n)  
THEN (action)

This causes the line to be exited as soon as one condition is found to be false without testing of subsequent conditions.

Should the operator be OR, a little more complex recoding is required:

IF (testable condition 1) OR (testable condition 2) OR ... (testable condition n) THEN (action)  
may be recoded

IF NOT (testable condition 1) THEN IF NOT (testable condition 2) THEN IF NOT ... (testable condition n) ELSE (action)

This causes the action to take place as soon as one condition is found to be true without testing of subsequent conditions. That is, the line is skipped as far as the ELSE clause.

Try replacing the THEN IF in line 60 of Program III with OR. When SIZE is 9 you will see that again the second condition is tested unnecessarily. But using the new coding suggested above – given in Program IV – no test of the second condition is made when the first is true.

It is essential that SIZE=9 be in brackets, since otherwise the high priority operator NOT operates on just SIZE on account of its having higher priority than "=" (see page 144 of the User Guide).

Note also that just as an ELSE clause is not compulsory, it is not illegal to have no THEN clause. An IF statement with neither clause, however, is pointless.

There is no point in recoding a line using only EOR operators as all conditions must always be tested anyway.

The above arguments may, of course, be extended to IF statements using any combination of the logical operators AND, OR and EOR. It may be necessary, however, to use brackets to override operator precedence.

These methods of preventing unnecessary tests will also reduce execution time, which may be useful in loops.

The problem of preventing un-

```
10 REM *** PROGRAM IV ***
20 MODE 7
30 REPEAT
40 INPUT "SIZE ", SIZE
60 IF NOT (SIZE=9) THEN IF NOT FNYE
SNO("WANT TO QUIT") ELSE PRINT "*** QUI
T ***"
70 UNTIL FALSE
```

```
10 REM *** PROGRAM V ***
20 MODE 7
30 I=0
40 REPEAT
50 I=I+1
60 PRINT"GAME",I
70 UNTIL I=5 OR FNYESNO("WANT TO QU
IT")
80 PRINT "*** QUIT ***"
90 STOP
```

```
10 REM *** PROGRAM VI ***
20 MODE 7
30 I=0
40 REPEAT
50 I=I+1
60 PRINT"GAME",I
70 IF I=5 THEN UNTIL TRUE ELSE UNTI
L FNYESNO("WANT TO QUIT")
80 PRINT "*** QUIT ***"
90 STOP
```

```
10 REM *** PROGRAM VII ***
20 MODE 7
30 I=0
40 REPEAT
50 I=I+1
60 PRINT"GAME",I
70 IF I=5 THEN UNTIL FNYESNO("WANT
TO QUIT") ELSE UNTIL FALSE
80 PRINT "*** QUIT ***"
90 STOP
```

```
100 REM *** PROGRAM VIII ***
110 DEF FNYESNO(Q$)
120 LOCAL A
130 PRINT Q$;" (Y/N) ? ";
140 REPEAT
150 A=GET AND &DF
160 UNTIL A=78 OR A=89
170 PRINT CHR$A;
180 REPEAT UNTIL GET=13
190 PRINT
200 =(A=89)
```

```
100 REM *** PROGRAM IX ***
110 DEF FNYESNO(Q$)
120 PRINT Q$;" (Y/N) ? ";
130 ON INSTR("YyNn",GET$) GOTO 140,1
40,150,150 ELSE 130
140 =TRUE
150 =FALSE
```

necessary testing of conditions in other statements – UNTIL for example – becomes a little more difficult.

Suppose you want a game to repeat until either a counter, I, equals 5 or you answer "yes" to the question "Want to quit?" asked at the end of each game.

The program in Program V will not do because even when I is 5 you will still be asked whether you want to quit. Line 60 represents the game and when the word QUIT is printed the program is actually exited.

The program in Program VI provides one solution via a change to line 70 by simply preventing the function call when I=5.

Line 70 in Program VII causes the game to repeat until I=5, when you are asked if you want to quit. Using AND in place of the OR in line 70 of Program 5 would be acceptable only if AND worked logically by not testing the second condition when the first is false.

### The function FNYESNO(Q\$)

The function in Program VIII may be called from any program whenever a

yes or no response is required. It causes its argument to be printed followed by (Y/N) ?, GETs a keyboard character from the user and returns TRUE for "Y" or "y" and FALSE for "N" or "n" and ignores all other characters.

The AND &DF in line 150 converts all Ascii codes for lower case characters to those for capitals (the Ascii codes for N and Y being 78 and 89 respectively).

(A=89) (line 200) has the logical value TRUE if A=89, that is if CHR\$(A)="Y", and FALSE otherwise.

Line 180 – REPEAT UNTIL GET=13 – causes the function to wait until the Return key is pressed (13 being the Ascii code for Return). If no such pause is required the line may simply be omitted.

Program IX shows an alternative yes/no function, but due to a bug preventing the use of an ELSE clause in ON ... GOTO and ON ... GOSUB in a function or procedure definition, it may not be used in the first version of BBC Basic. (See note on page 309 of the User Guide.)



# Games

## A name to PLAY with



**LANDFALL** (BBC B) AN EXCITING AND REALISTIC SPACE SHIP LANDING SIMULATOR by Gregory Trezise VGA 2002



**SPACE ADVENTURE** (BBC B) A GRAPHIC ADVENTURE SET ON A SEEMINGLY ABANDONED SHIP DRIFTING THROUGH SPACE by R. Thomas & A. Thomas VGA 2003



**BUG BOMB** (BBC B) A SKIN-TINGLING NEW ARCADE GAME GAME by Simon Birrell VGA 2001

### ● VIRGIN GAMES GANG

- With each title you buy before the end of August you get:-
- 1. An offer of One Year's Free Membership of The Virgin Games Gang.
- 2. Free Entry into The Virgin Games Gang draw on September 6th.
- First Prize - £500 of computer hardware or software of your choice
- Second Prize - £100 of computer hardware or software of your choice
- and 150 runner-up prizes of Virgin Games T-shirts or posters.
- 3. A Specially mixed piece of music by Steve Hillage - to play while you play.

- If your local retailer is not yet stocking Virgin Games - tell him he should be - but, however, you can order direct from "I've got no good local retailer" dept, Virgin Games Ltd, 61-63 Portobello Road, London W11. enclose a cheque or postal order for £7.95 for each title you want and don't forget to put your name and address - people do you know!
- Allow up to 28 days for delivery before complaining.
- Don't forget, if you want to make some money to buy some games from us or do whatever else you get up to and you have written an original games program, with good graphics for any of the popular home computers other than the ZX81, send a cassette version to us - it could make you rich.

# £7.95

Computer FUN... available NOW!

# Colourful brighten up

MODE 7 has many applications as it gives the most user memory of any of the modes on the BBC Micro. The unfortunate disadvantage that I find with this mode is that a colour control character is required at the start of each new line, or the display will remain black and white.

Here I illustrate four simple routines to put coloured characters on the screen. They could obviously also be used to give white letters on a coloured background, and with a little adaptation, coloured letters on a coloured background could be achieved.

There are two restrictions to using any of the routines directly:

- There must be no Printing in column 1 of the screen.
- The screen must not have scrolled since the last clear screen.

All the routines work by putting the colour control character in location &0C00 and in further locations in steps of 40.

**Routine 1** is a Basic procedure to illustrate how the method works. The procedure is from lines 1000 to 1050, with lines 10 to 100 calling the procedure to illustrate its use.

The program is self explanatory, with line 1010 adding 128 to X% so that the parameter carried to the procedure is the same number as the function key giving the same colour on the 1.2 OS.

**Routine 2** is in machine code to put colour on a quarter of the screen. In

LOOP, the X register is incremented and every 40 (counted in LOOP1 by the Y register) the control character is put in location &0C00 indexed by X.

To test the routine, type it in and run it. Then clear the screen by CTRL+L and list the program. If you then type CALLS% the top part of the list should change colour. To alter the colour change line 70 of the program and rerun it.

Alternatively the query indirection operator can be used to change the appropriate byte of memory.

**Routine 3** is basically Routine 2 written four times with different starting positions. Test it in the same way as Routine 2, but just list up to line 200 to prevent scrolling.

**Routine 4** is Routine 3 adapted to fit in the interrupt routine. This means that the first column of control characters is constantly refreshed and, subject to the two conditions previously mentioned, the screen will remain coloured.

To implement the routine, run it and check that it has assembled starting at &1080 (if it has not, the following will have to be adjusted accordingly). Then the vector pointing to the start of the interrupt must be changed to point to the start of this routine (the routine ends with a jump to the normal interrupt). To do this type:

```
?&204=&80:?&205=&10
```

After this, clear the screen and all further writing should be in colour. To

change the colour type ?&1088=n, where n is the appropriate colour code. Note that the memory location will be different if the program assembled starting somewhere other than &1080.

This routine can be removed from the interrupt by typing:

```
?&204=&93:?&205=&DC
```

although any colour already on the screen will remain there.

Note that programs will not load or save with this routine in the interrupt, but they will run satisfactorily, although slowed down slightly..

All these routines have been written so that they can be easily understood by inexperienced programmers and may give all programmers some new ideas.

It is hoped that more experienced programmers will use the ideas to write more efficient colour routines of their own.

One easy improvement is to set up a text window to prevent the colour control characters being touched. Try these extra lines in the first routine and test it by typing GOTO140:

```
140CLS  
150PROCCOLOUR(1)  
160VDU28,1,24,39,0  
170END
```

The screen should remain red and the two restrictions previously mentioned are overcome.

It should be noted that while the first three routines will run on any OS, Routine 4 will not run on OS 0.1.

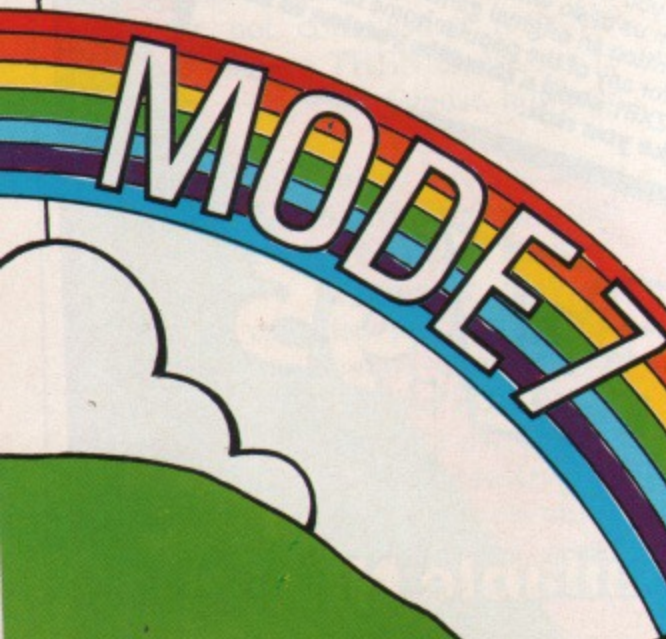

# characters your screen

```
1 REM ROUTINE 1
2 REM
10 CLS:INPUT"what colour required (
1-8)",C%
20 FORI=1TO160:PRINT" TEST*::NEXT
30 PROCCOLOUR(C%)
40 PRINT"PRESS SPACE TO SEE OTHER C
OLOURS"
50 A=GET
60 FORcolour=1TO8
70 PROCCOLOUR(colour)
80 A=INKEY(200)
90 NEXT
100 GOTO60
1000 DEFPROCCOLOUR(X%)
1010 X%=X%+128
1020 FORI%=31744TO32744STEP40
1030 ?I%=X%
1040 NEXT
1050 ENDPROC
```

```
1 REM ROUTINE 2
2 REM
10 DIM GAP% 100
20 FORI=0TO3STEP3
30 P%=GAP%
35 S%=P%
40 [
50 OPTI
60 CLC
70 LDA#130 \ PUT COLOUR CODE HERE
80 LDX#0
90 .LOOP LDY#40
100 STA&7C00,X
110 .LOOP1 INX
120 BEQ FIN
130 DEY
140 BNE LOOP1
150 JMP LOOP
160 .FIN RTS
170 ]
180 NEXT
```

```
1 REM ROUTINE 3
2 REM
10 DIM GAP% 100
20 FORI=1TO3STEP2
30 P%=GAP%
35 S%=P%
40 [
50 OPTI
60 CLC
70 LDA#130 \ PUT COLOUR CODE HERE
80 LDX#0
90 .LOOP LDY#40
100 STA&7C00,X
110 .LOOP1 INX
120 BEQ FIN
130 DEY
140 BNE LOOP1
150 JMP LOOP
160 .FIN LDX#0
170 .LOOPA LDY#40
180 STA&7CFO,X
190 .LOOPA1 INX
200 BEQ FINA
210 DEY
220 BNE LOOPA1
230 JMP LOOPA
240 .FINA LDX#0
250 .LOOPB LDY#40
260 STA&7DE0,X
270 .LOOPB1 INX
280 BEQ FINB
290 DEY
300 BNE LOOPB1
310 JMP LOOPB
320 .FINB LDX#0
330 .LOOPC LDY#40
340 STA&7EDO,X
350 .LOOPC1 INX
360 BEQ FINC
370 DEY
380 BNE LOOPC1
390 JMP LOOPC
400 .FINC RTS
410 ]
420 NEXT
```

```
1 REM ROUTINE 4
2 REM
10 DIM GAP% 100
20 FORI=1TO3STEP2
30 P%=GAP%
35 S%=P%
40 [
50 OPTI
51 SEI
52 PHA
53 TXA:PHA
54 TYA:PHA
60 CLC
70 LDA#130 \ PUT COLOUR CODE HERE
80 LDX#0
90 .LOOP LDY#40
100 STA&7C00,X
110 .LOOP1 INX
120 BEQ FIN
130 DEY
140 BNE LOOP1
150 JMP LOOP
160 .FIN LDX#0
170 .LOOPA LDY#40
180 STA&7CFO,X
190 .LOOPA1 INX
200 BEQ FINA
210 DEY
220 BNE LOOPA1
230 JMP LOOPA
240 .FINA LDX#0
250 .LOOPB LDY#40
260 STA&7DE0,X
270 .LOOPB1 INX
280 BEQ FINB
290 DEY
300 BNE LOOPB1
310 JMP LOOPB
320 .FINB LDX#0
330 .LOOPC LDY#40
340 STA&7EDO,X
350 .LOOPC1 INX
360 BEQ FINC
370 DEY
380 BNE LOOPC1
390 JMP LOOPC
400 .FINC PLA:TAY
401 PLA:TAX
402 PLA
403 JMP &DC93
410 ]
420 NEXT
```

# THE MICRO USER

A subscription will ensure you get your own personal copy **HOT OFF THE PRESSES** month after month for the next year.

# Be one of the first to get each issue!

Every owner of a BBC Micro – and everyone thinking of buying one – needs to get Micro User every month. It's the biggest, brightest, most authoritative yet complete independent guide to a machine that has so much potential you will never tire of reading about its remarkable capabilities.

You can buy Micro User from your local newsagent or station bookstall. Or you can take out a 12 months subscription and have it delivered by post.



Copies of these back issues are still available at £1.25



**Cassette tapes of Micro User programs – £3.75**

Or take out a year's subscription and have your cassette posted to you each month. You can start your subscription from any issue to take advantage of this offer.



# FREE

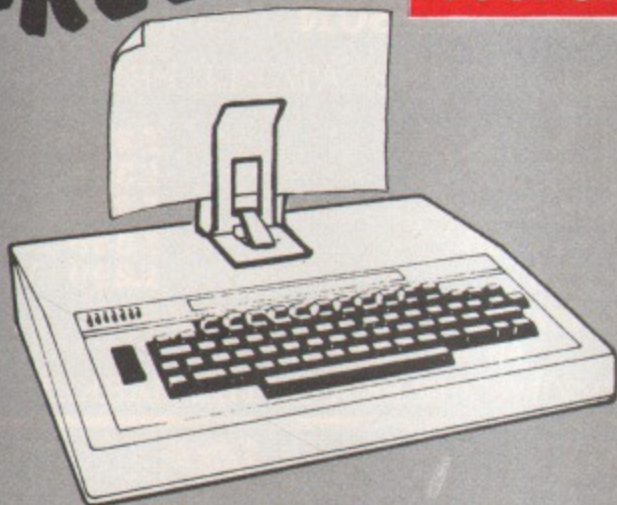

If you take out a subscription to *Micro User* you will receive completely free the sturdy copy-holder illustrated above, together with a large crib card containing essential information and charts that will save you continually referring to the User Guide. This free gift is for a limited period, so subscribe now!

**COMPLETE THIS COUPON TODAY**



**Sweat Shirts**  
**£6.29**

**T Shirts**  
**£3.29**

Blue printing on either light blue or white backgrounds

Keep your collection of *Micro User* complete with these handsome binders

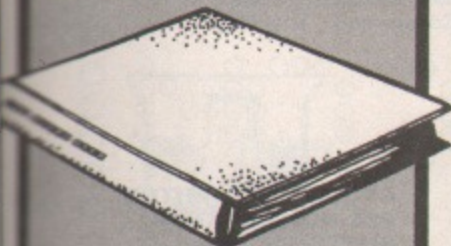

**£3.95**  
(UK)

**Your BBC Micro needs protecting!**



PVC dust covers  
**£3.25** Standard (beige)  
**£3.95** Deluxe (clear)

## ORDER FORM

All prices include postage, packing and VAT, and are valid to 30 August 1983.

Please enter number required in box £ p

### Micro User annual subscription

UK	£12	<input type="checkbox"/>
EIRE	£13	<input type="checkbox"/>
EUROPE	£18	<input type="checkbox"/>
Surface mail - USA	£15	<input type="checkbox"/>
Air mail - USA	£25	<input type="checkbox"/>
Surface mail - Rest of world	£15	<input type="checkbox"/>
Air mail - Rest of world	£30	<input type="checkbox"/>

Commence with ..... issue TOTAL .....

### Micro User back issues

<input type="checkbox"/>	£1.25 UK	March 1983	<input type="checkbox"/>
<input type="checkbox"/>	Rest of world:	April 1983	<input type="checkbox"/>
<input type="checkbox"/>	£1.50 - Surface	May 1983	<input type="checkbox"/>
<input type="checkbox"/>	£2.50 - Air mail	June 1983	<input type="checkbox"/>
		July 1983	<input type="checkbox"/>
		TOTAL	.....

### Cassette tape annual subscription

**£40** (UK & Overseas)   
Commence with ..... tape (state month) TOTAL .....

### Cassette tape single copies

<input type="checkbox"/>	£3.75	Deathwatch	March 1983	<input type="checkbox"/>
<input type="checkbox"/>	(UK & Overseas)	King Kong	April 1983	<input type="checkbox"/>
		Air Strike	May 1983	<input type="checkbox"/>
		Space Pilot	June 1983	<input type="checkbox"/>
		Tenpin	July 1983	<input type="checkbox"/>
		Fruities	Aug 1983	<input type="checkbox"/>
		TOTAL		.....

### Dust Covers

**£3.25** - Standard   
**£3.95** - Deluxe   
(UK & Overseas) TOTAL .....

### Binders

**£3.95** - UK   
**£5.00** - Overseas   
TOTAL .....

**T-Shirts £3.29** (UK & Overseas)

**Sweat Shirts £6.29** (UK & Overseas)

	T-Shirt		Sweat Shirt	
	Blue	White	Blue	White
Age 6-8		28"		
Age 10-12		30"-32"		
Small		34"-36"		
Medium		36"-38"		
Large		38"-40"		
Extra Large		40"-42"		

TOTAL .....

Payment: please indicate method (✓) TOTAL .....

Access/Mastercharge/Eurocard  
 Barclaycard/Visa  
 American Express  
 Card No. \_\_\_\_\_  
 Expiry Date \_\_\_\_\_  
 Cheque/PO made payable to Database Publications Ltd.



Name \_\_\_\_\_  
 Address \_\_\_\_\_  
 \_\_\_\_\_  
 Signed \_\_\_\_\_

Send to: **Micro User, FREEPOST, Europa House, 68 Chester Road, Hazel Grove, Stockport SK7 5NY.**  
(No stamp needed if posted in UK)

Or you can order by phone quoting credit card number and expiry date. **061-456 8383** 9am - 5pm  
**061-456 4157** (subscriptions/back numbers)

# STAR SOFT

## FANTASTIC INTRODUCTORY OFFER! 3 TAPES FOR THE PRICE OF ONE!! (£9.95)

Superb colour graphics and sound. Very user friendly. Launched and acclaimed at the **BBC Micro User Show.**

- PUB GAMES PACK** – Darts, Dominoes and two Card Games.
- PICASSO** – Auto Painting Programs.
- MICRO PAINT BOX** – Painless programming with our picture gallery – lets you frame our pictures and then list and frame your own.

Available early August from:

## STAR SOFT

9, Chatsworth Road, Worsley,  
Manchester M28 4NU.  
Tel: 061-794 8076

# PRINTER BONANZA!

## EPSON

PRINTERS AT UNBEATABLE PRICES



EPSON RX80	£275 + VAT
EPSON FX80	£365 + VAT
STAR 510	£299 + VAT
STAR 515	£389 + VAT
CP80	£299 + VAT

THE NEW 'STAR' AND 'CP' PRINTERS –  
AS GOOD AS EPSON

STAR & EPSON – THE BEST ON THE MARKET.



All printers carry a 1 Year Guarantee and come with paper. Shipment is by TNT Overnight Express to your door – Please add £7 + VAT carriage.

Payment by Cheque, Access, Visa etc.  
All prices apply to 31st August, 1983.

Shipments throughout UK. We can export to most countries in the world.

Please phone for Access or Visa buying details.



**IMMEDIATE DELIVERY.**

## Micro-Spares

We cannot and will not be beaten on Price!

Note our change of address  
104-106 Hanover Street, Edinburgh EH2 1DR  
031-226 3345

## Silicon Centre Edinburgh

	ex VAT	inc. VAT
<b>BBC Model B</b>	£348.26	£399.00
100K TEAC single disc drive	£179.00	£205.85
200K TEAC twin disc drive	£339.00	£389.85
800K twin double sided 80 track drive	£575.00	£661.25
800K PACE dual 40/80 switchable	£610.00	£701.50
400K PACE 40/80 switchable	£345.00	£396.75
<b>TORCH Z80 Disc Pac (800K + Z80 + 64K RAM)</b>	£755.00	£868.25
<b>EASYTABS PROFESSIONAL BUSINESS SOFTWARE FOR BBC/TORCH</b>		
Sales Ledger	£99.00	£113.85
Purchase Ledger	£99.00	£113.85
Cashbook	£99.00	£113.85
Word Processor	£99.00	£113.85
Mail List (Link to Word Processor)	£99.00	£113.85
Sanyo 12" Green Screen Monitor	£79.00	£90.85
Cabel 14" Colour RGB Monitor	£189.00	£217.35
Microvitec 14" Colour RGB Monitor	£239.00	£274.85
Epson RX80 Printer	£269.00	£309.35
Epson FX80 Printer	£359.00	£412.85
Star 510 Printer	£279.00	£320.85
Star 515 Printer	£379.00	£435.85
CP80 Printer	£279.00	£320.85
Juki Daisywheel Printer	£389.00	£447.35
Smith-Corona Daisywheel Printer	£469.00	£539.35
Byte-Writer Printer/Typewriter	£479.00	£550.85

Authorised BBC/Acorn Service Centre for Repairs, Upgrades, Modifications.

7 ANTIGUA STREET, EDINBURGH EH1 3NH.  
TELEPHONE: 031-557 4546

## For a lot of fun on your BBC – join our club

Members program listings, competitions, special offers, jokes and snippets of news and comments.

We have a vast selection of games, utility and business software ...

Over 150 titles currently in stock!

### THE STACOM TOP 10

Killer Gorilla (Prog Power)	Painter (A&F)
Road Runner (Superior Soft)	Castle of Riddles (Acornsoft)
Moon Raider (Prog Power)	Centipede (Superior Software)
Frogger (Various)	Alien Dropout (Superior Software)
Snapper (Acornsoft)	Meteors (Acornsoft)

### NEW TITLES

747, Space Shuttle, Snooker, Starship Commander.

### OTHER FAVOURITES

Wordwise, Logo, EDG Graphics, Jumbo, Chess, Cash Book Accounting, Mail List, Stock Control.

**DISC DRIVES:** From £265 – LVL (Shugart), TEAC & Torch (Z80 pack).

**PRINTERS:** Oki Microlines a speciality, also Seikoshas, Epsoms (the new FX80), the Spark Jet Printer and others.

**MONITORS:** Microvitec's CUB & Portatel's Luxor TV/Monitor 14" to 20".

**ACCESSORIES:** Joy sticks, Cassette players, Cassette boxes, Cables, Digitisers, Dust Covers and "The Plug".

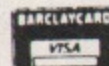

**STACOM LIMITED.**  
234 HIGH STREET,  
SUTTON,  
SURREY,  
SM1 1NX.

Telephone/Mail Orders Welcome : 01-661 2266

CHALLENGE GAMES presents



## MANSION MURDERS

Mansion Murders slowly reveals a web of suspects, weapons and motives, with time and place variations.

You can take risks—though you may get murdered yourself!

Every time you play you get a different situation, with thousands of variations—a strategy game which tests your deduction and logic.

Comes complete with rules and notes on tactics. Uses colour and 28k of program space.

£6.95 (postage etc. included) from

**CHALLENGE GAMES**  
64 Ferndale Road, London E11

## THE TYPING MASTER™ (The typing tutor that puts you in a class of your own)

The Typing Master program exists to teach you to type. The easily-met target is 30 words per minute with 95% accuracy over 30 half-hour sessions. The following facilities help you to accomplish this standard.

'Sight & Type' introduces you to the keyboard with the correct finger for each key and takes you to a speed of around 12 words per minute.

'Touch-Typing' takes you to around 24 words per minute at the same time ensuring you learn the peripheral keys to the same standard as those most commonly used.

'Practice Exercises' gives Non-timed accuracy orientated exercises and Timed speed/accuracy exercises. The results are given in words per minute and percent accuracy. The target standard (and far beyond) is achieved through this module.

'Session Monitor' holds your hand all the way through the course from first use of the program to that final, very useful result. To back up the program you get a 4-page documentation on how to approach the course and a record card to fill-in as you progress through the modules.

The Typing Master is not a toy. It is a professionally written program which has as its sole purpose the teaching of typing/keyboard skills in a way that is friendly and fun. It was written by a typing instructor and it has been marketed world-wide on CP/M, MSDOS, PC DOS and other operating system-based machines over the last two years.

Now it is available for the BBC Micro in two versions: 'Basic Version' (Single-user), or; 'Business/Schools Version' (up to 99 users). The latter adds other facilities including a 'Records File' module for the upkeep of each user's record.

**BBC Micro Basic Version (Model A or B) (cassette) £20.00**

**BBC Micro Business/Schools Version (disc only) £125.00**

Please send payment with order to:

**Anthony Ashpitel  
Software Systems,  
56 London Road, Harleston,  
Norfolk, IP20 9BZ.  
Telephone: (0379) 852807**

# BBC MICRO IN SCOTLAND



**Model B £399 EX-STOCK with Free cassette lead worth £4**

**WITH THE LATEST 1.2 OPERATING SYSTEM**

Disc Interfaces available ex stock £97.00 all inc.

### DISC DRIVES

Teac CS50A Single, 100K .....	£212.75
Teac CD50F Dual, 800K .....	£632.00
Teac CD50A Dual, 200K .....	£360.00
Cable and Format Disc & Manual .....	£11.50
Torch Z80 Disc Pack, 800K .....	£874.00

### PRINTERS

Seikosha GP100A .....	£215.00
Seikosha GP250X .....	£271.50
Epson FX80 III .....	£450.00
Interface Cable for above .....	£15.00

### MONITORS

Microvitec 14" Colour .....	£287.50
Cabel 14" Colour .....	£230.00
Zenith 12" Green Screen.....	£86.25

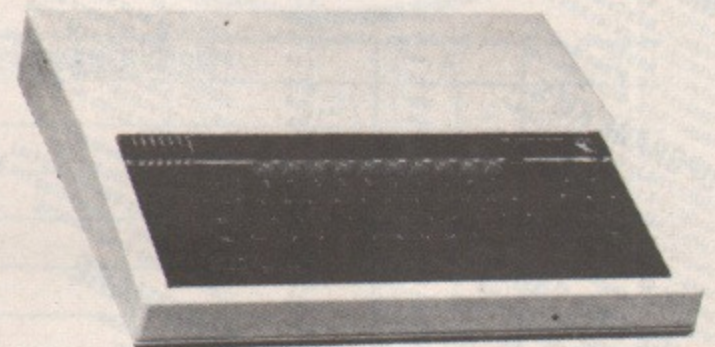

**SOFTWARE:** Full range of ACORNSOFT, IJK, MICRO-POWER, GEMINI, PLEASE CALL OR SAE FOR LIST. (ADD 50p POST PER ORDER.)



**EST. 1824**

## ANDREW WHYTE & SON LTD

(Authorised BBC Dealer and Service Centre)

**LEVEN HOUSE,  
12 LEVEN STREET, EDINBURGH,  
(Nr. Kings Theatre, Tollcross)  
TEL: 031-228 1111 (M-S 9-5.30)**



**EDUCATIONAL & BULK  
DISCOUNTS AVAILABLE**

Carriage £6 per item, all prices include VAT, please check price before ordering.





# AEROSPACE SYSTEMS DEVELOPMENTS LTD

## NEW PRODUCTS FOR THE BBC MICRO

### HARDWARE

1. **Biomedical amplifier** 2 channel instrumentation amplifier, opto-coupled for maximum safety. Measures all usual biomedical functions. Plugs into analog socket.  
..... £20.00
2. **Extender board.** Plugs into vacant ROM socket, allowing either an extra 16k of RAM or up to 64k of EPROM ..... £18.50
3. **Eprom programmer.** Automatic copying and programming of 2k and 4k single rail chips. RS423 1Mcs, or user port operation ..... £60.00
4. **Eprom eraser.** Erases up to 16 chips. Timer version available. Safety switch .... £20.00 With Timer ... £25.00
5. **Alarm Unit.** Protect your valuable equipment with our sonic alarm. 110dB at 3 metres. This is ABSOLUTELY SHATTERING!! Mains and integral NiCad battery operated. False alarms cause operation for one minute only, with auto reset ..... £56.00
6. **Cables.** Cassette leads (state termination required) ..... £2.00  
Printer cables (state printer type) ..... £10.00

### SOFTWARE AND SERVICES

1. **Wordprocessor.** Tape based 4k program, offering fast operation insert and closeup, search and replace, justification, line length up to 240, infinitely variable page length.  
Cassette and manual ..... £5.75
2. **Mailer.** Tape based mailing list program, Auto tape search for named records, which may be of any length up to 240 characters. Sort and merge, save and load all or part of lists. Very fast operation.  
Cassette and manual ..... £5.75
3. **Utilities.** A cassette containing various utility programs such as screen print, screen save, a disassembler, string and integer sort, tape bug fix, bad program fix, graph plotter (up to 5 curves).  
Cassette ..... £5.75
4. **Tape and disc copying, printing.** Fast, professional copying of cassette and disc. Prices on application, but around 40p per single sided cassette for quantities up to 500, this includes labels and plastic box. Post and packing extra. (£2.50 up to 50 off, £1.00 for each extra 75 off).  
Printing service. Confidential service using Epson and letter quality printers. Prices £2.50 per 2,000 words Epson, £3.50 per 2,000 words letter quality. Tapes or disc must be written using our Wordprocessor or "Wordwise" (except for listings).
5. **Good programs required.**  
We pay 40% royalties on good programs, which need not be games. You retain copyright.

Send cheques and postal orders to:

**ASD Ltd., 30 West End, Launton, Bicester, OXON.**

(No cheques cashed until goods are dispatched)

Except where stated, prices include VAT and postage.

## BBC OWNERS

Why not consider the HOBBIT FLOPPY TAPE SYSTEM for your computer?

The HOBBIT gives you all the facilities you would expect from a floppy disc at a fraction of the price.

### Brief Specifications

- ☆ Read/Write speed of 750 BYTES per second
- ☆ Capacity: 101K BYTES per CASSETTE
- ☆ Average access time 22 seconds
- ☆ Up to 138 FILES per CASSETTE
- ☆ Completely automatic – no buttons to press
- ☆ Fully built, boxed and tested. Just plug in and go
- ☆ System can support TWO DRIVES

Available from stock **PRICE £135.00 plus VAT P&P £3.00**

Also available for NASCOM computers **PRICE £120.00 plus VAT**  
Manual only £1.50

Access and Barclaycard accepted

The Hobbit is available from most good computer dealers.

For more details contact:

# Ikon Computer Products

KILN LAKE, LAUGHARNE, CARMARTHEN, DYFED, SA33 4QE. Tel: Laugharne (099 421) 515

# CONTROL THE WORLD...



HAVE you ever seen those science fiction films where the hero is confronted by an all-powerful computer controlling every aspect of the planet's environment and defence? Said hero then has to outwit the computer before the credits roll and you can all go home.

He does this by asking some enigmatic question like "How?" or "Why?" at which the whole machine starts to smoulder and smoke before it bursts into flames, showering sparks all over our retreating hero.

As those of us with computers well know, if we try this sort of thing what actually happens is the computer answers with SYNTAX ERROR or MISTAKE – a little easier on the hardware, if a trifle dull.

This month we shall see how you can control external devices with your computer and, if you are brave enough, really put the wind up the next person perpetrating an error.

The simplest way of getting the BBC Micro to control devices is through the user port. Last month we saw how we could access this easily using the transition board, and this will be needed for this month's exercises as well.

When the user port is used as an

## –or at least eight bits of it!

By MIKE COOK

output it gives a signal of 0 volts or +5 volts. This is sufficient for controlling many devices, but the output cannot be used directly. The reason is that the VIA which constitutes the user port can only supply about 1.5 mA, and so this current has to be amplified before it can accomplish anything useful.

As we are not increasing the voltage available but only the current, this type of amplifier is sometimes called a buffer, which is actually an impedance matching circuit.

As the VIA can only supply a small current, we say it has a high output impedance. Some devices, like relays for example, may require a large current to drive them and so are said to have a low input impedance.

Therefore a buffer is used as it can convert a high impedance signal into a low impedance signal.

The type of buffer required depends on the device you are controlling and its impedance. For the purposes of this article, impedance can be considered to be the same as resistance.

Let's look at a practical example to see what I mean. One of the devices

you might want to control is an indicator light, and a very convenient type is a LED, or Light Emitting Diode (see Figure 1). This has quite a high impedance, but not high enough for us to dispense with a buffer.

Typically, a LED will need 10 mA flowing through it to give adequate

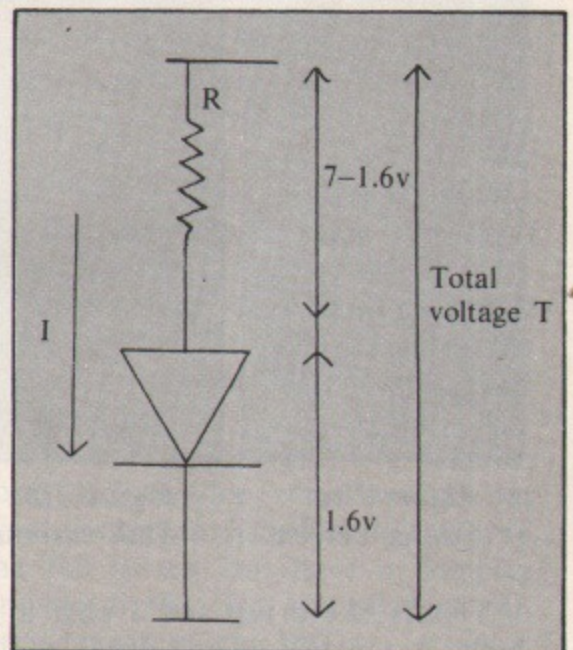

Figure 1: Voltage and currents on an LED

brightness. In addition, when the LED is on it will have about 1.6 volts across it (this is for a red LED – other colours

## THE BEEB BODY BUILDING COURSE

## From Page 79

have 2.7 volts). Therefore to drive this from 5 volts we need a resistor to limit the current.

Ohms law states that  $E=I \cdot R$ , where  $E$ =voltage in volts (using  $V$  would be just too easy),  $I$ =current in amps (see comment on  $E$ ) and  $R$ =resistance in ohms.

With this formula you can work out the value of resistor needed for the LED. The resistor has  $(5-1.6)$  volts across it and 10 mA (0.01 amps) flowing through it, and so we need a resistor of 340 ohms.

After all that calculation we find that they do not make a 340 ohm resistor, and so we have to settle for the nearest standard value of 330 ohms.

This may seem a little strange, but a lot of electronic design is based on careful calculation and then gross approximation. In this case the approximation was made in how much current is needed. The more current the brighter the LED, until finally it burns out. Most LEDs are rated at 20 mA, and so you see the resistor value is not at all critical.

Having arrived at this arrangement how can we control it? There are two basic methods. One is to source the current and the other is to sink it.

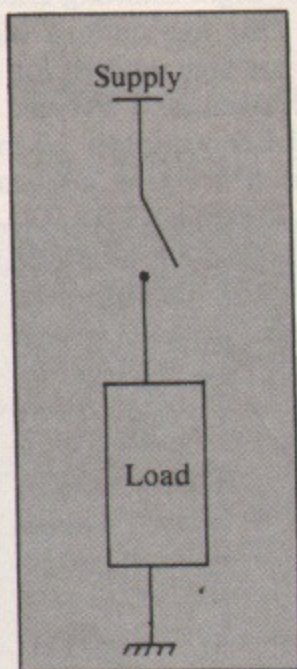

Figure IIa:  
Source current

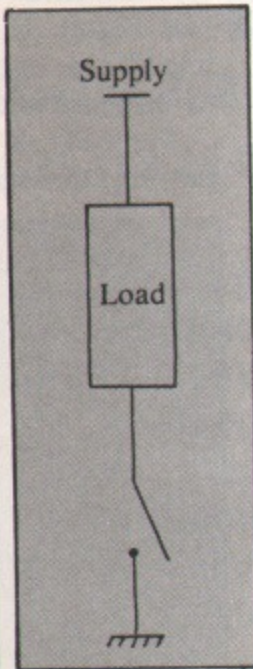

Figure IIb:  
Sink current

This is like a tap and a plug in a bath. A tap will source water and a plug hole will sink water. In both water is flowing.

You can draw a parallel between water and current, for both flow along a circuit. To see how current can be sourced or sunk look at Figures IIa and IIb. In each, the controlling device is

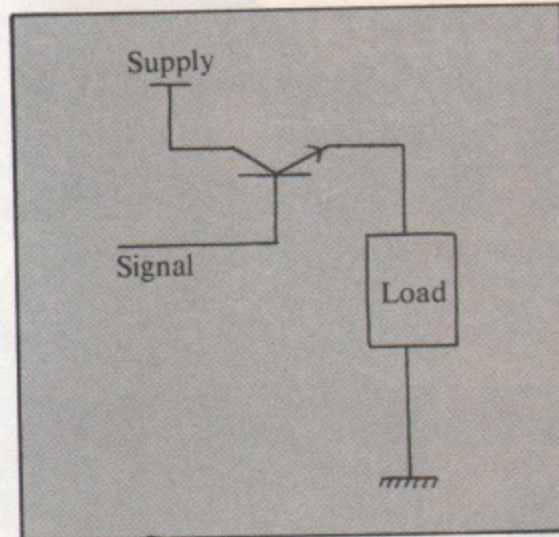

Figure IIIa: Source switch

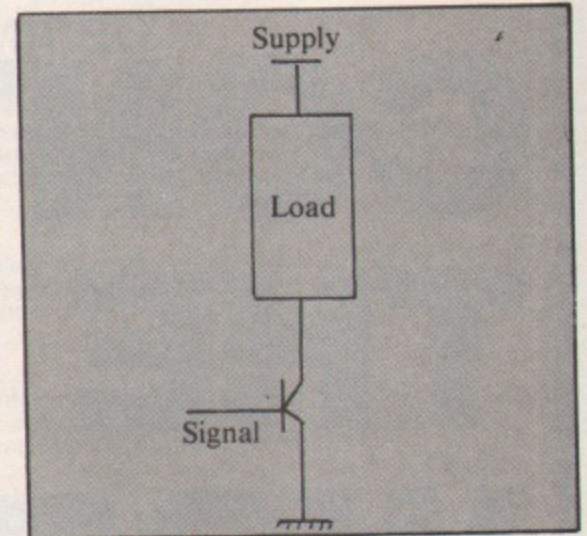

Figure IIIb: Sink switch

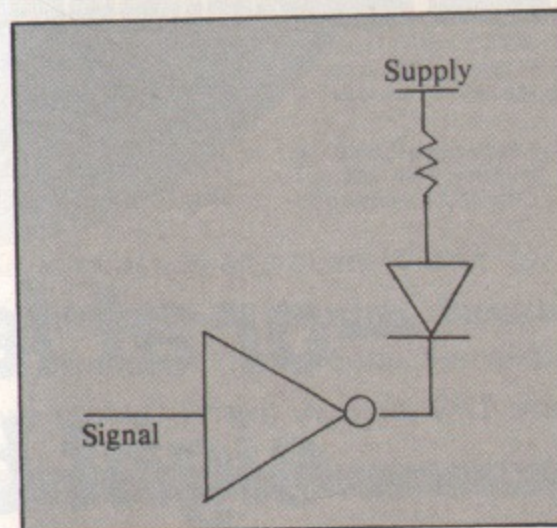

Figure IV: LED driven from buffer

shown as a switch. If it were indeed a switch there would be no difference between the two circuits.

We need a switch we can control, and typically that means a transistor. This produces the two methods of control shown in Figures IIIa and IIIb. The second method is the preferred one. (You might know it would be as it is not the one you would expect!)

The advantages of sinking current over sourcing current is that there is a 0.7 volt drop across the base emitter of a transistor, and so this would limit the

available voltage.

This is important because not all logic devices give 5 volts as a logic one. Some give as low as 3 volts.

Also many TTL devices (Transistor Transistor Logic) have what is known as an open collector output. That is, the collector is the output connection and the emitter is connected to the 0 volt line.

If just a single LED is needed then it is possible to use the circuit in Figure IIIb, but a much more economical approach is to use an open collector TTL buffer.

Figure IV shows the LED being driven from a buffer. The device 74LS05 has six such buffers in it and should cost less than 20p.

Figure V shows the relationship between the buffers and the pins. Note that these are inverting buffers, and so a logic one will turn on the output transistor (closing the switch) and the LED will light, just as we would expect.

Well, that is one piece of extra hardware wired up. Now what is needed in the way of software to control it?

The first thing we need to do is

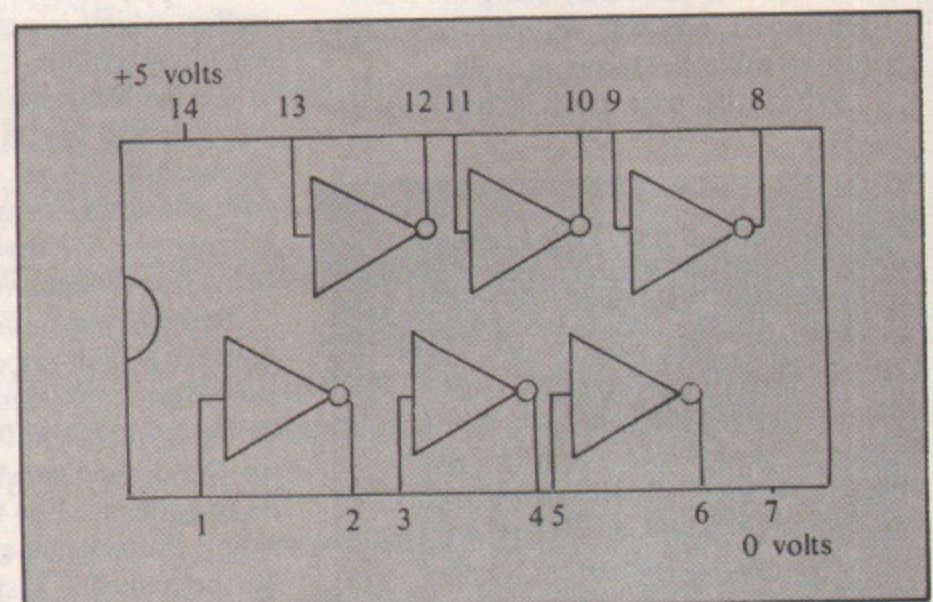

Figure V: Pinout of 74LS05 buffer



# THE BEEB BODY BUILDING COURSE

program the VIA to tell it which bits are going to be used as outputs.

As we saw last month, the register that controls this is called the Data Direction Register, and is located at address &FE62 (remember that "&" indicates a hex value).

For each bit on the user port which we want to use as an output we must store a logic *one* in the corresponding bit in the data direction register.

For example, suppose we want to use bit 4 to control our LED, then we store the bit pattern 00010000 (&10) at address &FE62.

This can easily be done using the indirection operator. Thus the command ?FE62=&10 would set bit 4 as an output and all the rest as inputs. (Note that this does not work over the Tube. See my comments last month on this.)

This setting up or initialisation need only be done once at the start of a program or session. However, whenever the break key is pressed this will initialise the VIA so that all the bits are inputs.

You can reprogram the break key so that the user port is initialised the way you want and so avoid this problem.

When a bit is initialised as an input and you have connected it up as an output you will have the effect of a permanent logic *one* output.

Many external devices are the simple on/off type and so we only need to store a *one* at the appropriate bit for it to turn on. Likewise, to turn it off, we need only store a logic *zero* in the bit.

The problem comes when there is more than one output, because any write to the user port affects all the outputs at once. What we need is a method of altering only the bit we want while leaving the rest of the outputs unchanged.

To do this you first need to read the value currently on the outputs by using the indirection operator on the left hand side of the equals sign.

Next, only the bit you want to change must be altered and that value then written back to the user port.

The instructions you need to change a bit are the logical operators AND, OR and Exclusive OR. Each one changes bits in a different manner.

These can best be understood by looking at a few examples.

We will define the byte (8 bits) we want to change as "the word" and the number we use to change it as "the mask". So in our case the word will be the result given by the instruction

?&FE60, a reading of the user port.

Suppose we want to set bit 4 to a logic *one*. To set bits we must use the OR operation.

The mask now has to be worked out. With an OR operation a *one* in the mask will produce a *one* in the word, a *zero* in the mask will leave the word unchanged.

Note that this operation is carried out on each bit in the byte separately. So our mask for setting bit 4 is 00010000 or in hex &10. Thus the instruction:

?&FE60=?&FE60 OR &10

will turn on the device connected to bit 4. Similarly, to turn off bit 4 we must use a mask, but this time with the AND operator.

The rules for the mask for this logic operator say that a *zero* in the mask gives a *zero* in the word, and a *one* in the mask leaves the word unchanged. This makes the mask a little bit more difficult to work out.

What we want is a *zero* at bit 4 and logic *ones* everywhere else. This gives a

mask of 11101111 (or in hex &EF) to turn off bit 4. Thus the instruction:

?&FE60=?&FE60 AND &FE

will turn off the device connected to bit 4.

Having seen that OR turns a device on and AND can be used to turn it off, then what does Exclusive OR do?

This allows you to reverse the state of a bit, which has the technical name "toggling".

The rules for the mask are that a *one* in the mask inverts the corresponding bit in the word, and a *zero* in the mask leaves the word unchanged. This type of operation is very useful for flashing lights, where all you want to do is to alter their current state.

Having a good grasp of the three logical operators will allow you easily to control any of the bits you want without affecting the others.

This technique can also be used when setting up the data direction register so as to initialise only the bit you want.

Try and work out a few examples yourself. Write the mask down on paper in terms of bits before converting them to a number.

Figure VI shows every different bit combination for word and mask for each logical operator. Remember the number can be a decimal one if you insist, but hex really is easier.

Since we are able to wire up any of our user port data bits to control the LEDs, we can use them in all sorts of applications.

For example, it can be a valuable form of indication when you do not want the screen disturbed. In this way the full screen can have a complex graphic display and user prompts can be indicated on the LEDs.

Instructions can also be embedded in programs when fault finding to indicate the program flow or the state of variables without disturbing the screen format. This is especially useful when

The OR operation				
0	1	1	0	Word
0	0	1	1	Mask
0	1	1	1	Resulting word
The AND operation				
0	1	1	0	Word
0	0	1	1	Mask
0	0	1	0	Resulting word
The Exclusive OR operation				
0	1	1	0	Word
0	0	1	1	Mask
0	1	0	1	Resulting word

Figure VI: The bitwise combinations of logical operators

## From Page 81

working with machine code.

It can also be useful if you want to animate the lights in a model.

There are other techniques for controlling devices that require more current (or "oomph", to use a technical expression). One way is to use a relay to control the larger current.

The only snag is that then you have to control the relay. This can be done with transistors, as it is inside the BBC Micro, but there is a better and more universal way of controlling a medium to high current device. This is by using the little-known VMOS power FET (Field Effect Transistor).

These devices are just the job for connecting to a micro as they need no

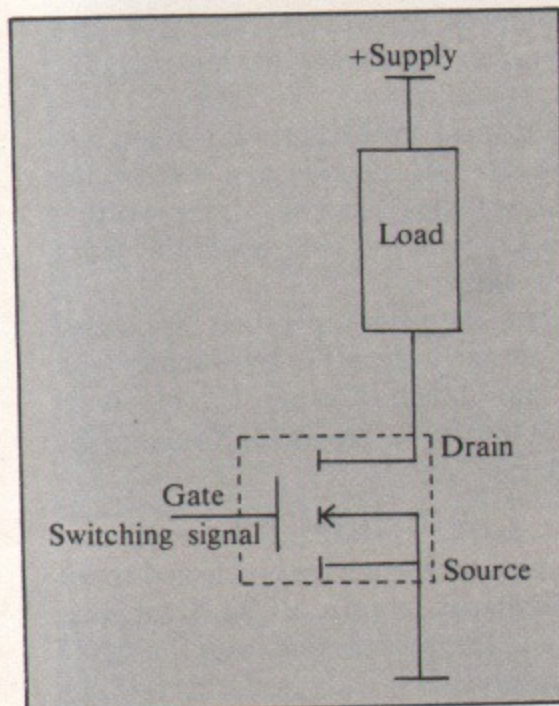

Figure VII: A VMOS FET

extra components. Also they are not worried by back EMF (if you don't know about back EMF there is no need for you to be worried by it either).

This means they are ideal for switching inductive loads and some devices can switch up to 3 amps at 80 volts directly connected to the output of the user port.

There is really nothing to using them, either. Figure VII shows the general arrangement.

The only three connections to it are the gate – the controlling input – the source, which goes to the earth connection, and the drain, which is connected to the load.

The names of source and drain appear to be the wrong way round

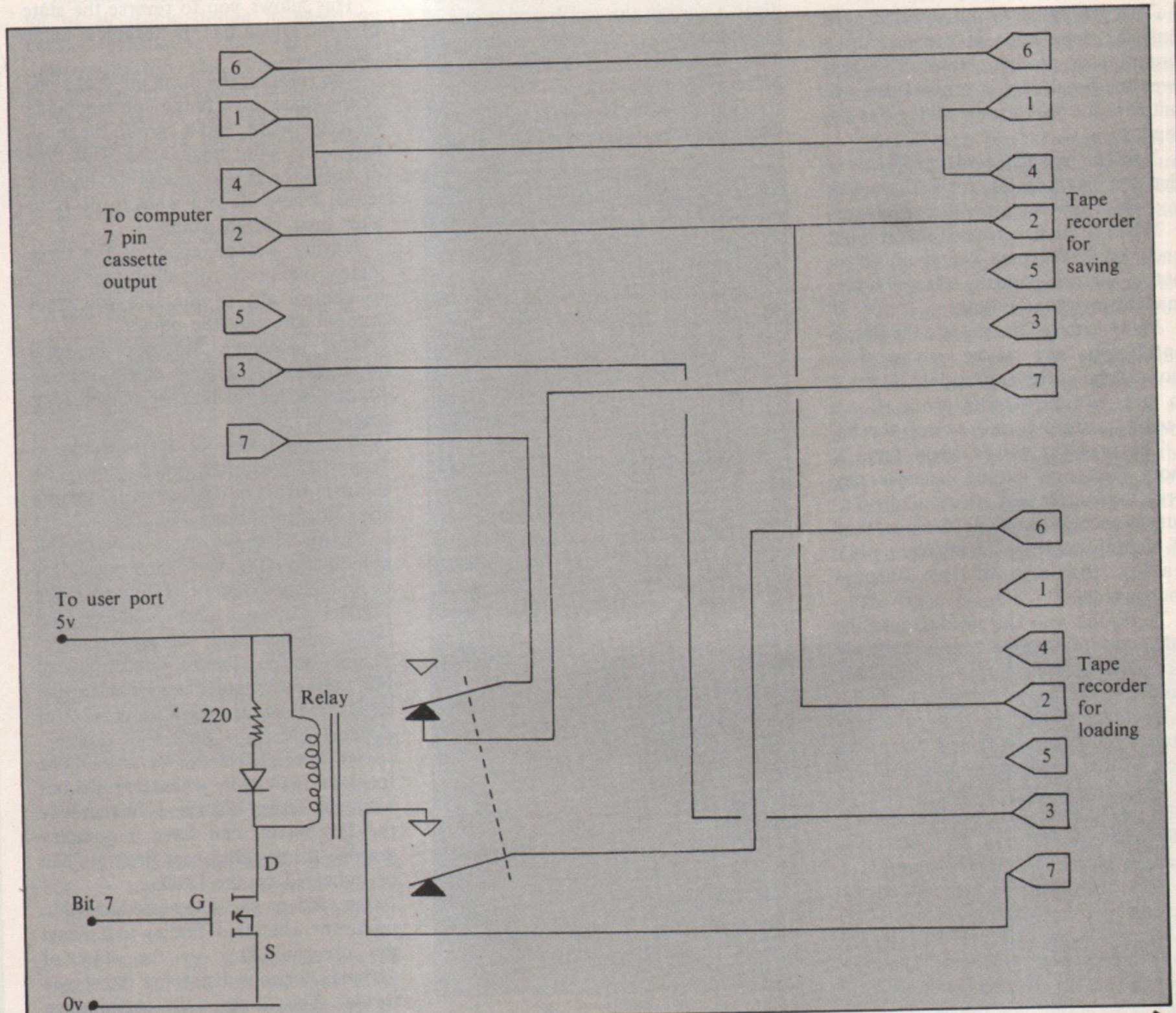
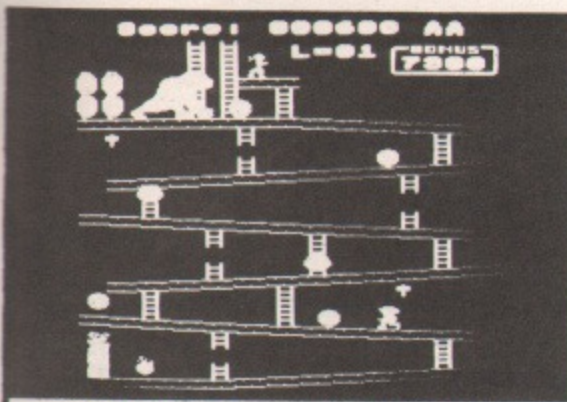

Figure VIII: Dual cassette system



**FRAME 1** - Leap barrels and fire-balls or grab a hammer and smash them while climbing to the top.

You are Morris, a running barrel-jumping man, intent on rescuing the maiden from the clutches of the evil gorilla **KONG** who has her captive. As you climb the ladders and girders towards your goal you must negotiate the many hazards, and if possible try to collect the lady's possessions simultaneously. But each time you reach her **KONG** carries her off to a new location. Your only hope is to hack out the girders supporting **KONG** at the fourth location. Will you make it? Time is your enemy. It will require all your skill. **GOOD LUCK.**

**FRAME 3** - Jump on and off the lifts to cross the screen, passing the bouncing jacks to finish the frame.

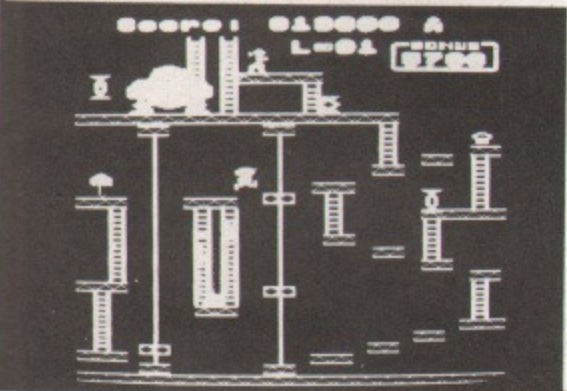

## For the 32K BBC Micro

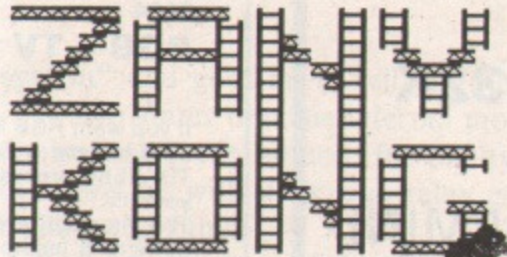

©1983 Christopher Hyde and

**SOLAR SOFT**



- JOYSTICK OR KEYBOARD
- SOUND (ON OR OFF)
- FULL COLOUR GRAPHICS
- 100% MACHINE CODE
- 4 DIFFERENT FRAMES
- TOP 10 HIGH SCORE TABLE
- FOR ALL M.O.S. VERSIONS



**SOLAR SOFT**  
Dept. B,  
5 Westmorland  
Drive,  
Camberley, Surrey  
GU15 1EW.

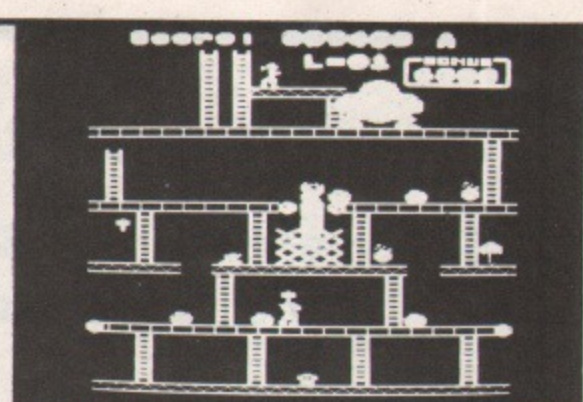

**FRAME 2** - Run along the conveyor belts avoiding the pies and **KONG** himself. Mind the moving ladders.

**£6.50** for tape fully inc.

**£9.00** for disc fully inc.

Immediate despatch on all single orders. Dealer enquiries welcome.

If YOU have written any quality BBC software send us a copy (preferably documented) on a cassette or disc, and if it comes up to our standards we will pay the top royalties for its sale.

**FRAME 4** - Remove the eight bridges by crossing them, and smash the fire-balls, to send **KONG** falling to his death.

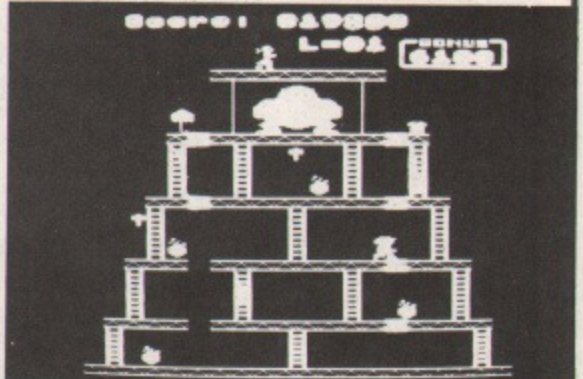

# Bourne Educational Software

## HAPPY NUMBERS

Uses full colour graphics to present attractive images to encourage children to learn their numbers and count. No reading skills required for this very easy to use program.

- Children encouraged through attractive flower collection and happy/sad face responses to their entries.
- Full use of sound reactions, but only with correct answers!
- Incorrect entries show equivalent number, then original entry counts to correct number. Records every entry to identify problem figures.

Suitable for 4-6 year olds and BBC Model B.

## WORLD-WISE

Two programs enabling children to build up fascinating information banks on their favourite geography subjects. Covers both UK and World in a series of 10 categories including, e.g. canals, towns, antiquities, etc. Your atlases and reference books well used as they try to find a river that passes through the Equator, or who built the Parthenon! Features:

- Powerful review/edit facilities to correct entries if required.
- Save and load the data at any time.
- Personalised responses with attractive sound.
- Maintains extensive information on individual childrens' entries.

Suitable for ages 7-15 and BBC Model B.

## WORDHANG

Educational version of 'hangman' word game, with full colour graphics and simple but attractive screen layout. Children no longer find learning to spell a chore as they try to keep him alive! Host of attractive features include:

- Lists totalling 260 words to suit reading age/subject. Facility to create and save own lists - ideal for that weekly spelling list!
- Time limit can be set for each guess.
- Monitors individual childrens' performance - time taken, list used, correct/incorrect attempts, etc.

Suitable for ages 5-13 years and BBC Model B.

## QUALITY EDUCATIONAL PROGRAMS

"... already proving very useful and popular ... envisage being widely used by children." Mr I. Wilson, Headmaster, Weybridge C.E. Middle School.

AVAILABLE FROM GOOD BBC MICRO DEALERS

BES, Dept BU5, Bedfield Lane, Headbourne Worthy,  
Winchester, Hants SO23 7SQ. Tel: (0962) 882474 **BBC**

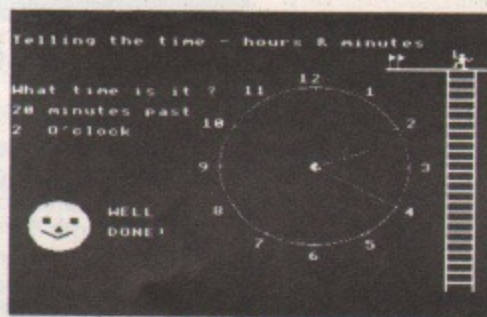

## TIMEMAN ONE

## TIMEMAN ONE

Children will love learning to tell the time and set the clock with **TIMEMAN ONE**. Right/wrong answers shown by happy/sad faces and figure climbing up (or down!) ladder. On completion of each stage the figure dances a jig to a tune and plants a flag.

Choice of any one of progressive stages comprising:

- Telling hours ● Telling minutes ● Telling hours and minutes
- Setting hours ● Setting minutes ● Setting hours and minutes
- Attractive use of sound, but level adjustable. ● Children shown the correct answer after each wrong entry, and the chance to try again. ● Features full **BES MONITOR** - records individual childrens' separate entries. ● Ability and needs easily identified, practice at specific stages can then be chosen.

Ideal for 4-9 year olds and BBC Model B.

## ANIMAL/VEGETABLE/MINERAL

Think of an object and see if the computer can guess it correctly! Children love 'educating' the computer as it fails to get the answer right.

- Stimulates fascinating (and educational!) discussions as to the difference between alligators and crocodiles, and whether oil is vegetable or mineral.
- Encourages use of reference books as children try to find the answers to their own questions.
- Maintains full information on individual childrens' entries.

Suitable for ages 7-13 years and BBC Model A and B.

All programs feature explanatory booklet. Postgage and packing FREE. For 24-hour despatch by first-class post, send cheque to BES now!

Code	Item	Cassette		Disk		Total
		Qty	Price	Qty	Price	
19	Word-Wise	—	£8.97	—	£10.99	£
20	Wordhang	—	£8.97	—	£10.99	£
21	Animal/Vegetable/Mineral	—	£5.69	—	£10.99	£
22	Happy Numbers	—	£8.97	—	£10.99	£
23	Timeman One	—	£8.97	—	£10.99	£

I enclose cheque payable to BES

Total: £

Name .....

Address .....

# Norsoft

## Software for the BBC 32K and Spectrum

I.J.K.

GEMINI

Send S.A.E. for details

91 Roundwood Road, Northenden, Manchester M22 4AD.

## 40% ROYALTIES

Paid to the writers of high quality, original software, including: Games, Educational and Business Programs.  
FOR USE ON THE BEEB.

Don't delay make contact today with

### GLENGARY-SOFT

9 Highfield Crescent, Hornchurch, Essex, RM12 6QB.  
Telephone: Hornchurch (04024) 40864

## BBC Micro-Aid

SOFTWARE - Programs that are guaranteed to run! Save hours of work and worry with these utilities and practical programs on cassette or disc. Orders are posted the same day.

102	CASHBOOK	Double entry 4 columns with accounts & analysis	£ 5.95	B
102d	CASHBOOK	Full disc version. 1100 items on 100k disc	£ 9.95	B
103	LEDGER	Complements CASHBOOK with ageing & analysis	£ 5.95	B
104	MAILING	Holds 218 addresses. Alpha & post code sorts, fast search, any format labels & update	£ 5.95	B
105	PAYROLL	In 2 parts to handle (separately) weekly or monthly PAYE & NI for 100 employees. Fully supported.	£13.90	B
105a	Manual	30 page A4 manual with examples. Extra. No VAT.	£ 2.50	
106	MEMO-CALC	Database/Calcsheet with up to 255 columns, string or numeric data, sorts, searches, calculations, with automatic fully formatted printout facility	£ 9.95	B
106a	Manual	20 page A4 manual with examples. Extra. No VAT	£ 2.00	
201	CARDS	Beat Bruce Forsyth at his own game. State model.	£ 2.95	A/B
202	BATTLE	Fast moving game simulation of a minefield	£ 2.95	B
203	HANGMAN	Word game in English, French, German, Italian, Spanish	£ 7.95	B
301	BANNER	Printout large text and graphics on paper	£ 2.95	A/B
302	DISTANCES	Three graphic maps of U.K., EUROPE & the WORLD. Calculate the distance between any 2 places.	£ 3.95	B
303	FLAGS	98 full colour flags of the world with questions	£ 3.95	B
304	STATPACK	Statistics package giving over 30 results	£ 8.95	B
504	PROCAID	Includes SEARCHBAS to search a BASIC program and alter it. PROCVAR to list variables in a BASIC program & PROCFLUSH to clear resident integers in RAM	£ 3.45	A/B
505	UTILITY-A	Our best selling tape includes PROCAID DEFCHR to design, display & store graphic characters. SORTM/C a very fast machine code numeric sort. SORTBAS The undisputed fastest BASIC sort routine	£ 5.95	A/B
600	FORTH	79 FORTH second language ROM for either OS	£34.74	B
601	LOGO-FORTH	Another language ROM for the BBC Micro	£55.00	B
602	TINY PASCAL	Structured language ROM for the BBC Micro	£34.74	B
605	WORDWISE	Superb fast & easy Wordprocessor in ROM	£34.00	B
606	BEEB-CALC	ROM based spread sheet with floating point maths	£19.00	B
607	DISKDOC	ROM for disk problems in format, search, files etc	£19.00	B
608	PRINTPAK	Toolkit ROM for screen dumps, spooling etc.	£ 6.95	
721	BOOKS	Various titles for the BBC Micro from	£ 4.50	
801	CASSETTES	C12 Computer quality tapes boxed in 10's	£19.95	
810	5.25" DISCS	MEMOREX Soft sectored 40 track S/S	£279.00	
901	EPSON RX-80	Superb printer. 100 cps. 3 fnts. graphics, tractor	£379.00	
902	EPSON FX-80	Magnificent. 160 cps, 6 founts. graphics. F/T Roll		
910	DISC DRIVES	Slimline TEAC or MITSUBISHI with power supply, 100k-800k format disc cable and excellent manual. From	£199.00	
920	VDU STAND	Stainless Steel Support protects your micro	£19.95	

ADD VAT TO ALL PRICES EXCEPT MANUALS AND BOOKS.  
FOR COPIES ON DISCS ADD £1.50 PER DISC. NO PACKING CHARGES.  
MOST PROGRAMS AVAILABLE ON MICRONET 800.

If you want further information before parting with your hard earned cash send for our free brochure to:-

Micro-Aid (MU)  
25 Fore Street, Praze, Camborne, Cornwall, TR14 0JX.  
Tel: 0209-831274

## R. UPFIELD

### RADIO & T.V. SERVICES

4 High Street, Botley, Southampton SO3 2EA. Phone: Botley 5004

RGB + TV for £69. + VAT

If you want RGB Monitor quality with normal T.V. capability and you already have a Ferguson TX9 or TX10 (or any set fitted with the TDA3560 processing IC) we now have an interface that will convert your TV.

The interface gives a picture with good resolution, solid colours and no patterning (comparable to RGB only monitors). Switching between RGB and normal TV is automatic with no switches or lead changing. Other sets may be converted at extra cost.

For further details write to: R. Upfield or phone Neil Smith on Botley 5004.

(Interface as supplied to and approved by the Hampshire Education Authority).

## TEACH YOUR CHILD AND JUSTIFY YOUR MICRO!

O.K. So your wife hasn't said much but I bet she's thinking "What a pointless object that box is." She has probably told her friends as much too - how you sit there in the evening killing monsters! Change all that with:-

● **TABLES (B or 32K A):** Suitable for 5-11 year olds, this single program provides graded questions in basic arithmetic (+, -, x, ÷) from very easy to very hard. No time wasting cassette changing - its all in one program. Corrections are graphically displayed with sound and colour as are speed and scores. Adults love it too! **£5.99** incl. p&p.

● **SPELLINGS (B or 32K A):** Suitable for 5-11 year olds, it can hold hundreds of words chosen by you or the program. Works on the 'flash card' principle as used in most schools. Scores, music, graphics, too. Progress rewarded by HANGMAN. School spelling tests will suddenly be fun. **£5.99** incl. p&p.

So wait till your child comes first in class. Your wife will tell her friends for sure. To justify your micro and reputation send cheque to: E.C.L. Software, 29 Richmond Close, Ware, Herts SG12 0EN.

## SAPPHIRE Software

BBC 32K OS 0.1 1.2

### FROGJUMP

Guide the little frogs to their spawning grounds in the river bank, to get there they must cross a busy main road and ford a fast river. Negotiate four lanes of traffic, three lanes of logs and two lanes of (diving) turtles. Watch out for the snakes, get extra points for catching flies and lady frogs on the way. Superb use of mode two colour graphics and sound, machine code screen updating for extra speed. One of the best versions around for the BBC ..... **£5.95**

### OTHELLO

Excellent use of mode five graphics, two player version or choose from seven levels of play, change level or colour at any time, hint facility if you get stuck. The deluxe version of this challenging game of strategy ..... **£5.95**

### FUN PACK

Three super games on one tape:  
GOMOKU - Play the computer to get five pieces in a line on a 19 by 19 Go board in this traditional game from the east.  
SPACEMAZE - A multi level three dimensional maze with full 3D graphics. Can you find your way out before you run out of air?  
LIFE - The ever popular game of life. Seed a culture with cells watch them growth, breed and die. Mode four graphics for maximum cells and machine code updating for speed.  
Excellent value for money ..... **£5.95**

Prices fully inclusive.

**SAPPHIRE SOFTWARE**  
BOX 67, Wakefield, W. Yorks.

## From Page 82

because the solid state physicists who dream up these devices describe everything in terms of electron flow.

Electrons flow from negative to positive. Mere mortals use the conventional current flow, which is from positive to negative (obvious, but as usual, wrong).

The other end of the load is connected to the supply, and on these devices can be up to 80 volts and still

As the dual cassette system uses some components you might not readily be able to get hold of, we have produced a kit of parts. The kit, known as Body Build Pack 3, consists of:

1 Two-pole change-over 5 volt relay.

1 VN10KM power VMOS FET.

1 Green LED and limiting resistor.

3 PCB-mounting 7-pin DIN sockets.

2 7-pin DIN plugs with 1ft of 6 core cable.

1 Small piece of perforated copper strip board.

● It is available from The Micro User for £9.95, including p&p and VAT. There is an order form on Page 87.

be switched by the 5 volt output of the user port.

The V in VMOS comes from the way they are constructed internally with a V groove forming the channel for the current to flow down each wall.

With one of these devices and a relay we can add a second cassette recorder to the BBC Micro. This allows you to have one recorder for saving and one for loading.

In addition, if you have a program that handles data you will not be restricted to using files that can be wholly contained in the computer at any one time.

As you have two recorders you can load in a portion of your file, modify it (or not) and then write it out to the second recorder before loading the next part in.

This is a technique that you can normally only use with disc files. It means the size of the data base you can handle is only limited by the playing time of the tape (and your patience).

On page 433 of your hymn book (the User Guide) it states that you can "easily implement a dual cassette

system" and goes on to tell you how.

It also states that the internal motor control relay can be used for one type of operation with your own relay controlling the other.

Being a simple and trusting soul I tried the suggested method, only to find that whatever I did the internal relay kept coming on.

A phone call to Acorn assured me that there was no fault with either the operating system or the manual, the implication being that I was doing something wrong.

After much beating my head against the computer and many more phone calls insisting something was wrong I got to speak to someone really technical.

He listened to my problem and said he would ring me back in 20 minutes when he had tried what I suggested.

My call was returned in less than that time and I was greeted by a voice saying "Yes, you are completely right!"

Apparently some problems with the serial ULA had resulted in a patch being put into the operating system (1.2 no less) that turns the cassette relay on and off very rapidly just before a LOAD and SAVE but after the OSBYTE call has been made. This is the electrical equivalent of giving it a thump!

This cured the problem, but left the cassette relay on, exactly as I had found.

In another priceless quote from Acorn I was told that the person who wrote that part of the User Guide "did not fully ascertain what we meant", which neatly avoided admitting to an error.

I was told that I would have to use two relays to implement this as they did when they tested it "in house".

Well if there's a chance to go one better than Acorn I'm not one to pass it up, so I designed a dual cassette system that uses only one relay.

The circuit is shown in Figure VIII. It uses a double-pole change-over relay - that is, two sets of relay contacts that move at the same time.

The internal relay is wired through the normally closed contacts of one of the poles before going to one recorder. This means that the recorder is switched on only if the internal relay is on AND the external relay is off.

The other recorder is wired up conventionally to the normally open contacts. An LED is added to indicate

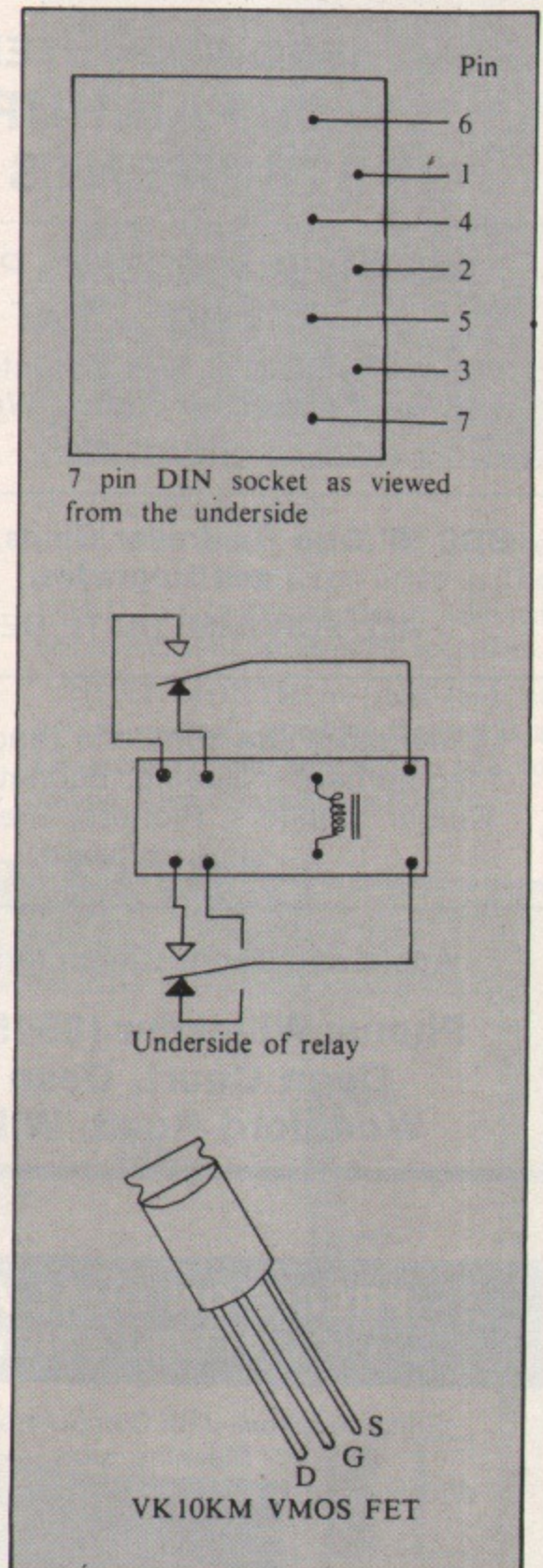

Figure IX: Component pinout

when the external relay is activated.

I do not believe in giving practical circuit layouts. The reason being it introduces too many errors, not only in their production but also by people trying to follow them.

With a theoretical circuit you can follow the flow of the signal or whatever and can wire it up in an orderly fashion.

However, with a practical layout it is very easy to miss something and, as you well know, no amount of looking will make you see it again.

It is really not very hard to acquire the skill of looking at a circuit diagram and connecting the wires up to the right place. Also fault finding is so much easier as you know where every com-

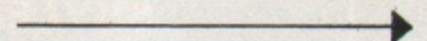

**BBC COMPUTERS  
FROM FAIRHURST  
INSTRUMENTS LTD.**

**WORD PROCESSING PACKAGE  
£999 + VAT**

Includes: BBC 'B' with disc interface, disc drive, daisywheel printer, Wordwise, all cables etc.

**BBC 'B' Disc Controller Chips, Disc Drives  
and Upgrades.**

**ALL FOR IMMEDIATE DELIVERY**

We stock the complete range of BBC equipment including, Econets, Printers, Colour Monitors, Plotters, Graphic Tablets and Software.

Apple and Torch Computers available.

**Phone: Wilmslow (0625) 533741  
Dean Court, Dean Row,  
Woodford Road, Wilmslow.**

**Introducing . .**

**NEW**



- ★ Pupils
- ★ Teachers
- ★ Travellers
- ★ Students
- ★ Graduates
- ★ Linguists
- ★ In fact anyone having an interest in French will benefit from this unique language learning aid

- ★ Ready made lessons provide an enormous vocabulary of words, phrases and verbs arranged in subject groups.
- ★ Lessons can be run in three ways; learning, self-test or speed and accuracy test.
- ★ Clear, large-format displays including all French accents; different colours for masculine and feminine words.
- ★ Full tape editing facilities allow an infinite number of new or updated lessons to be created and stored for later use.
- ★ Runs on all operating systems including systems fitted with disc.

Choice of Level A or B cassettes with totally different vocabularies. **£9.95** each (P&P inc.)  
Both cassettes include extensive word lists; verbs and phrases are introduced in Level B. Available from dealers or mail order.

**COMING SOON!** "The German Master", "The Spanish Tutor"

**Kosmos**

**SOFTWARE**

1 Pilgrims Close, Harlington,  
Beds. LU5 6LX.  
Tel: 05255 3942

**PRECISION DUAL AXIS  
CONTROL STICK**

Suitable for use with Computers, Robotics,  
Machine tools.  
Widely used by Government departments and  
industry.

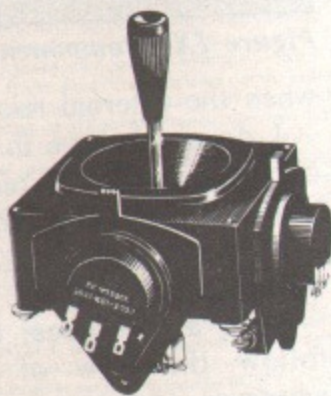

**SUPER SMOOTH PRECISE ACTION, SEPARATE FINE  
TRIM ADJUSTMENT, ACCURATE CENTRING, LONG  
LIFE MOULDED NYLON PARTS**

Available in kit form - easily assembled.

Standard version - Carbon track Pots. 1 off **£8.50**  
P & P 75p

De luxe version - conductive plastic film pots.  
1 off **£12.80** P & P 75p

Send SAE for full details of sticks and servos suitable  
for Robotics.

OEM and Trade Enquiries invited

**SKYLEADER**

Airport House, Purley Way, Croydon,  
Surrey, CR0 0XZ. Tel: 01-686 6688

**MICROMODE COMPUTER  
CORRESPONDENCE COURSES**

**LEARN BBC BASIC the easy way**

In your own home - at your own pace

★ ★ **BASIC 1** ★ ★

**A FIRST COURSE IN TEN lessons only £18\***

*Some of the features covered:*

Jargon explained, variables, editing, repeat until, for next step, procedures, arrays, decision making, string handling, cassette data filing, special BBC features, debugging graphics, hints and tips and much more.

The course is two-way with tutor guidance throughout the ten lessons, marking your assignments and monitoring your progress.

Special Package for Educational Establishments.  
\* Or lessons 1-5 for £10, with an option to take lessons 6-10 for a further £10.

Enrol today: Post the coupon to:

**MICROMODE, 32 West End Avenue, Gatley,  
Cheshire, SK8 4DR. Tel: 061-428 6683.**

NAME .....

ADDRESS .....

I enclose cheque/postal order to the value of  
£ .....

**From Page 85**

ponent is and what it does. All in all it is good for your soul.

The main problem people have when working with perforated copper strip board is when it comes to breaking the tracks. A lot of people simply do not! It is surprising how a fine wafer of copper may be still be connecting the track.

A way to avoid this is to scratch the place where the track is supposed to be broken with a screwdriver.

Also see Figure IX for the relationship between the components' leads and their functions. This is known technically as the "pin out" of a device.

Having produced the hardware, a software patch is needed to intercept the OSBYTE routine and control the extra cassette relay.

The machine code program sits at the bottom of the free space in page &D. This is to allow you to run other programs, such as screen dumps, which always seem to start at &D00.

Also if you have discs (which use this space) you would hardly be wanting a dual cassette system, would you?

It can however be relocated. I have used bit 7 to control the relay but you can change that if you want by changing the masks in lines 50, 60, 210 and 240.

The program initialises the VIA and then loads the patch into memory. Next it moves the OSBYTE vector in &20B and &20B into a space at the end of the program, and then puts a new vector into this location to direct all OSBYTE calls into the patch.

Finally, it reprograms the break key

# THE BEEB BODY BUILDING COURSE

to re-install the patch.

All you need to do is run the program and then forget about it. The LOAD and SAVE commands will then be redirected to use separate recorders.

**NEXT MONTH** we shall look at how to control something that needs a lot more oomph and allows you to extend your controlling influence.

```

10 PRINT "DUAL CASSETTE PATCH"
20 PRINT "BEEB BODY BUILDING COURSE"
30 PRINT "AUGUST 1983"
40 PRINT "BY MIKE COOK"
50 ?&FE62=?&FE62 OR &80
60 ?&FE60=?&FE60 AND &7F
70 FOR A=0 TO 2 STEP 2
80 PZ=&DDA
90 [
100 OPT A
110 .PTCH
120 CMP #137
130 BNE USNO
140 TYA
150 CMP #0
160 BEQ AWRITE
170 TXA
180 CMP #0
190 BEQ DONE2
200 LDA &FE60
210 ORA #&80
220 JMP SKIP
230 .DONE2 LDA &FE60
240 AND #&7F
250 .SKIP STA &FE60
260 RTS
270 .AWRITE LDA#137
280 .USNO JMP (VECT)
290 .VECT NOP:NOP
300 ]
310 NEXT
320 ?VECT=?20A
330 ?(VECT+1)=?&20B
340 ?&20A=PTCH MOD 256
350 ?&20B=PTCH DIV 256
360 PRINT "PATCH NOW INSTALLED"
370 *KEY 10 ?&FE62=&80: ?&FE60=0:
?&20A=&DA: ?&20B=&D :M
    
```

## YOUR ORDER FORM

for the Beeb Body Building packs

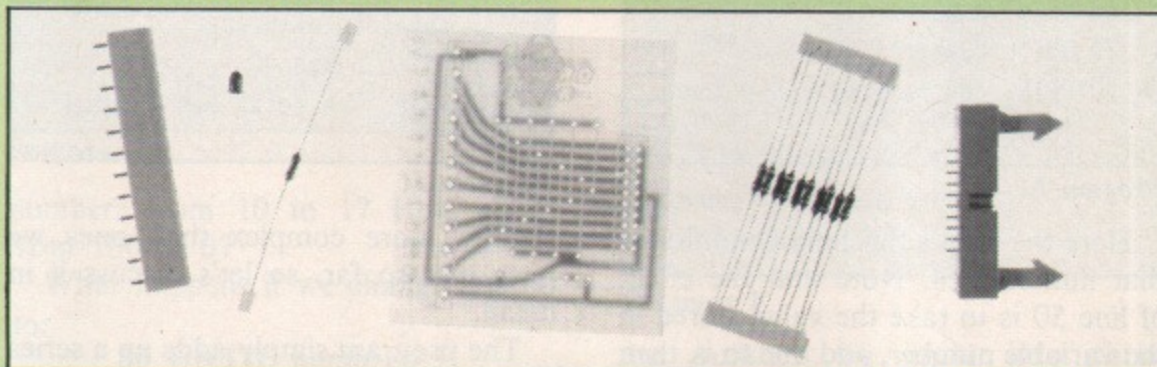

Beeb Body Building Pack 1

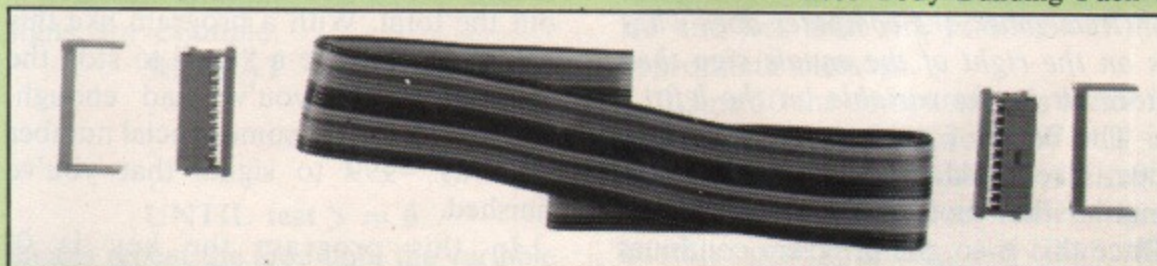

Beeb Body Building Pack 2

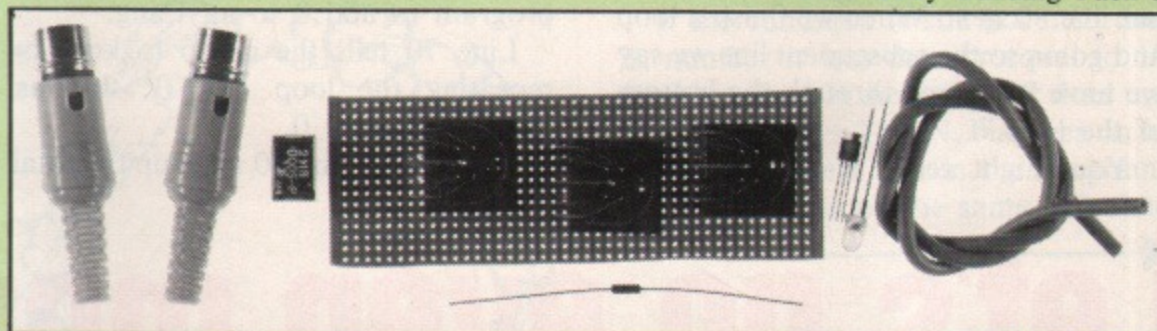

Beeb Body Building Pack 3

Beeb Body Building packs cost £9.95 each, £18.95 for two or £26.50 for all three. The prices include VAT. Packs 1 and 2 were described on Page 83 of the July issue, and Pack 3 on Page 85 of this issue.

Please send me:

- No.
  - Beeb Body Building Pack 1 £.....
  - Beeb Body Building Pack 2 £.....
  - Beeb Body Building Pack 3 £.....
  - Combined Packs 1 and 3 £.....
- Plus post and packing £ 1.00

Name .....

Address .....

Total \_\_\_\_\_

POST TO: BBC Packs, Micro User, Europa House, 68 Chester Road, Hazel Grove, Stockport SK7 5NY.

Please allow 28 days for delivery

# Part six of MIKE BIBBY'S introduction to programming

LAST month we looked at creating a loop using the idea of REPEAT... UNTIL.

REPEAT marks the beginning of the loop, UNTIL marks the end. The lines of code to be repeated, that is, those lines between REPEAT and UNTIL, are termed the body of the loop.

Directly following UNTIL, on the same line, is the loop's condition. This is the test by which the micro decides whether to finish the loop or not.

Program I uses this technique to print out the numbers 1 to 24.

```
10 REM PROGRAM I
20 MODE 6
30 number = 0
40 REPEAT
50 number = number + 1
60 PRINT number
70 UNTIL number = 20
80 PRINT "We have finished the
loop."
```

Program I

Here the loop's finishing condition is that number=24. Note that the effect of line 50 is to take the value stored in the variable number, add one to it, then store it back in the variable number.

*(Remember, the computer does what is on the right of the equals sign then stores it in the variable on the left.)*

The body of the loop, lines 50 and 60, is repeated until the condition is met - that is, UNTIL number=20. Once this is so, the program continues in order of the line numbers, carrying out line 80 next. When we finish a loop and go on to the subsequent line we say we have "dropped through the bottom of the loop."

You might recall from last month

that if we were to make line 70:

```
70 UNTIL FALSE
```

the loop would repeat indefinitely. This is because the program hasn't given the micro anything to be FALSE, so it keeps repeating.

You see, the BBC Micro is very sweet natured - it believes everything is TRUE until it is told otherwise!

Try making line 70:

```
70 UNTIL TRUE
```

and your loop will "disappear". To our ingenuous micro, all is gospel!

Have a look at Program II. This is

```
10 REM PROGRAM II
20 MODE 6
30 total=0
40 REPEAT
50 INPUT "A NUMBER",number
60 total=total+number
70 UNTIL number=0
80 PRINT"The total was ";total
```

Program II

slightly more complex than ones we have met so far, so let's discuss it in detail.

The program simply adds up a series of numbers that you input then prints out the total. With a program like this it's useful to have a "key" to stop the program when you've had enough. That is, you input some special number such as -999 to signal that you've finished.

In this program the key is 0, since you wouldn't want to use the program to add 0 to anything.

Line 70 tells the micro to keep on repeating the loop UNTIL the last number input is 0.

Notice how line 60 adds up the total.

It's a bit like our previous lines such as

```
number=number+1
```

Let's go through it, adding a couple of numbers:

Initially total is zero. Then line 50 inputs a number. Let's say it's 2. Line 60 adds this to the total, which is at this point zero, and stores the result ( $2=2+0$ ) in the variable total. So now the total is 2, which is correct since we have only input one number, 2.

The loop then repeats, since the last number input wasn't zero, and you're prompted for another number. Let's assume we chose 6 this time, so number has the value 6. Line 60 adds this to the previous total (2) then stores the result ( $8=6+2$ ) back in total.

If we then went on to input a 4, line 60 would add this to the current total (8) and store it back in total ( $12=8+4=6+2+4$ ) which now contains the sum of all the inputs.

I think you can now appreciate that, as we continue with this, total would continue to contain the total of the figures since line 60 updates total at each input.

When we wish to put a halt to the proceedings we simply input 0. Although line 60 will add this to the total, adding zero makes no difference to it. However, when we meet line 70 the condition is now met as number = 0 and the loop finishes. We drop out of the bottom of the loop and proceed to line 80, which then prints the total.

To change subject slightly, do you remember from your schooldays the symbols > and <? The first means greater than and the second means less than.

For example,  $6 > 3$  means 6 is greater than 3, which is true.  $5 < 3$

## Let's go even more





means 5 is less than 3, which is a downright lie!

These symbols are known as inequalities.

*(If you're anything like me, you'll get confused between > and <. The trick is to remember that, for both symbols, the largest number goes opposite the bigger end of the symbol, whereas the smaller number goes opposite the sharp, or smaller, end. It may not be the way Einstein remembered it, but it works well enough for me!)*

Look at Program III. This simply

```
10 REM PROGRAM III
20 MODE 6
30 number=0
40 REPEAT
50 PRINT number
60 number=number + 2
70 UNTIL number = 10
```

Program III

prints out numbers in ascending steps of 2 from 0 to 8.

Notice that it never actually prints out 10. To see why, suppose number has reached 8 and that its value has been printed out by line 50. Line 60 then adds 2 to number to make it 10. This "trips" the loop condition of line 70, which means that the loop isn't repeated so that number is not printed out when its value is 10.

Alter line 70 in Program III so that it reads:

**70 UNTIL number > 10**

Now the final condition for the loop is that the value of number must be greater than 10. If you run the altered program you'll find that 10 is printed out this time.

To see why, suppose that number has reached 8 and line 50 has printed it. Line 60 then increases the value of number to 10. Line 70 checks to see if number is greater than 10.

Of course number isn't greater than

ten, it's exactly 10, so the loop is repeated and line 50 prints out 10.

Then, of course, 2 is added to number by line 60 making it 12. This then "fails" the test on line 70 since 12 is greater than 10.

Try changing line 60:

**60 number = number + 0.5**

Before you run it, see if you can predict the final number to be printed!

Program IV demonstrates the use of the less than sign, <. Hopefully, it should be fairly clear. Can you alter the program so that it prints out all the

```
10 REM PROGRAM IV
20 MODE 6
30 number=10
40 REPEAT
50 PRINT number
60 number=number - 1
70 UNTIL number < 5
```

Program IV

numbers from 10 to 1? How about from 100 to 0?

What happens if we change line 80 to:

**80 UNTIL number > 5**

We can combine the <, >, and = signs, for example:

**REPEAT**

.

**UNTIL test > = 6**

means repeat the loop until the variable

test is greater than or equal to 6.

Similarly, =< means less than or equal to.

Less obviously, <> means not equal to.

By now we are used to the idea of testing for conditions at the end of a REPEAT ... UNTIL loop. Let's have a look at another method of testing for conditions - the idea of IF ... THEN.

Here we tell the computer IF such and such is true THEN do something. For example, in Program V we use the IF ... THEN test three times to sort

```
10 REM PROGRAM V
20 MODE 6
30 REPEAT
40 INPUT "A Number",number
50 IF number > 10 THEN PRINT
number " is greater than 10."
60 IF number = 10 THEN PRINT
number " is equal to 10."
70 IF number < 10 THEN PRINT
number " is less than 10."
80 UNTIL FALSE
```

Program V

the number we input into three categories - greater than ten, equal to ten and less than ten, printing out the appropriate message.

In line 50 the computer tests to see if number is greater than 10. IF this is true (that is the condition is met) THEN the computer does something - in this case printing out that the number is greater than 10.

If the condition is still not met, that is, number is less than or equal to 10 (number <= 10) the computer does not do what follows THEN, but goes on to perform the next line in the program.

Line 60 is much the same, this time

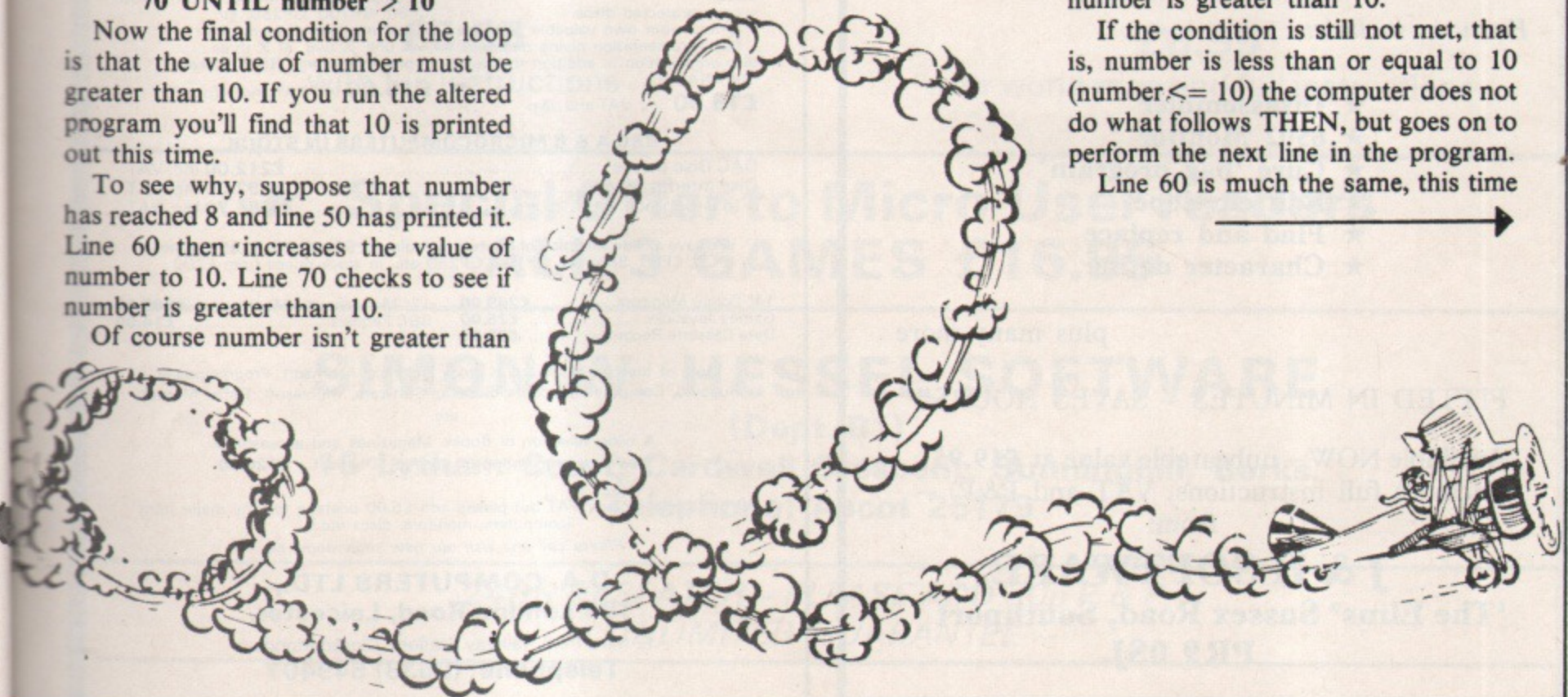
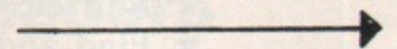

## From Page 89

printing its message only if number is equal to 10.

Line 70 then checks to see if number is less than 10, and prints out the appropriate message.

The whole thing is tied up in a REPEAT ... UNTIL loop so you can keep on testing to make sure that the IF ... THEN statement really does work.

You don't have to follow THEN with a PRINT statement - you can follow it with a GOTO, as Program VI makes clear.

This rather silly program just keeps on prompting for a string. If you input anything other than YES, the program

loops back and prompts for a string again. This is not the best of programs, but it does illustrate two points:

- The use of the symbol <> meaning not equal to. Notice we're using it with a string - it's not limited to numbers.
- Although we've used GOTO to create a loop, unlike our previous loop with GOTO this is a conditional loop. If string\$ isn't YES the micro does what follows THEN: it goes to 30, since the condition after IF is true.

If string\$ is YES, the condition has not been met so the micro does not do what is after THEN. That is, it doesn't go back to 30, but drops through to line 50.

Program VII should be quite easy to understand - it uses a REPEAT ...

UNTIL loop to print out the numbers 1 to 6.

Program VIII performs exactly the same operation using a conditional GOTO, and <=, which means less than or equal to.

Which of the two programs do you think is easier to follow?

I think that most would agree that it's far easier to understand the REPEAT ... UNTIL loop.

The use of GOTO nearly always makes a program harder to read, and for a variety of reasons its use is to be discouraged.

**NEXT MONTH we shall be looking at the FOR ... NEXT loop, and will really start putting our micro to work.**

```
10 REM PROGRAM VI
20 MODE 6
30 INPUT "Do you want to finish",
string$
40 IF string$ <> "YES" THEN GOTO
30
50 PRINT "Alright, we'll stop."
```

Program VI

```
10 REM PROGRAM VII
20 MODE 6
30 number=1
40 REPEAT
50 PRINT number
60 number=number+1
70 UNTIL number>6
```

Program VII

```
10 REM PROGRAM VIII
20 MODE 6
30 number=1
40 PRINT number
50 number=number+1
60 IF number <= 6 THEN GOTO 40
```

Program VIII

## UROM FOR THE BBC MICRO

UROM is a ROM chip containing a number of time-saving utility programs for your BBC Micro. It is an essential tool for the development of both BASIC and machine-code programs.

Features include:

- ★ Disassembler
- ★ 6502 Monitor
- ★ Cure 'bag program'
- ★ Edit envelope
- ★ Find and replace
- ★ Character define

plus many more

**FITTED IN MINUTES - SAVES HOURS!!**

Available NOW - unbeatable value at **£19.95** (includes full instructions, VAT and P&P) - from:

**J & H SOFTWARE,**  
**'The Elms' Sussex Road, Southport**  
**PR9 0SJ.**

## B.B.C. ACORN COMPUTERS IN LEICESTER

Specialists on hardware and software

\* Fully authorised ACORN-BBC Dealer \*

\*\* Complete after sales service - repairs and maintenance contracts\*\*

- |   |  |
|---|--|
| ★ <b>ANALYSE DISC</b> ★   | ★ <b>SCREEN DUMP ROM</b> ★                                   |
| - recover information from damaged discs.   | - copy any screen in any mode.                               |
| - copy protected discs.   | - compatible with MX80, FX80, RX80, CP80, GP100, GP250, etc. |
| - protect your own valuable software.   | - fast machine code dumps.                                   |
| - full documentation giving details of disc organisation in addition to how to use ANALYSE. | - X one, X two, or X three.                                  |
| <b>£15.00</b> inc. VAT and p&p  | - plugs into page ROM socket.                                |
|   | <b>£15.00</b> inc. VAT and p&p                               |

### BBC A & B MICROCOMPUTERS IN STOCK

DAC Disc Drives .....	<b>£212.00</b> inc. VAT
Disc Interface Kits .....	<b>£92.00</b> inc. VAT
A to B Upgrade Kits .....	<b>£66.70</b> inc. VAT

We have a wide selection of Printers including EPSON FX80, RX80, Shinwa CTI CP80, Seikosha GP100, GP250 etc. in stock prices from £200.

14" Colour Monitors .....	<b>£269.00</b>	12" Monochrome Monitor .....	<b>£100.00</b>
Games Joysticks .....	<b>£25.00</b>	BBC Paddles .....	<b>£14.00</b>
Data Cassette Recorders .....	<b>£39.00</b>		

Most of the best software in stock including Acornsoft, Programpower, Bugbyte, Computer Concepts, Superior Software, Nibblesoft, Fisher-Marriott etc.

A wide selection of Books, Magazines and accessories.  
See a demonstration of the PLS Digitiser - **£120.00**

All our prices include VAT but please add £5.00 postage for any major item (computers, monitors, discs etc.)

Please call and visit our new showrooms at:-

**D.A. COMPUTERS LTD.,**  
**104 London Road, Leicester.**  
(2 mins from Railway Station). Closed Mondays  
**Telephone: (0533) 549407**

# FINANCIAL GAMES

## GREAT BRITAIN LTD.

AS SEEN ON  
SWEDISH TV

**Ever thought you could run the country better?**

*Here is your chance.*

As Prime Minister (of the party of your choice), you have to guide the country through its social and economic ills for five years, then put yourself up for re-election.

*"Great Britain Ltd is easily as exciting, and certainly more satisfying, than any game of space invaders"*

*Micro User, June '83*

*"A must for all budding politicians"*

*Computer Answers, June '83*

*"Thoroughly enjoyable and worthwhile decision-making activity and, as such, it can be thoroughly recommended"*

*Educational Computing, June '83*

**£5.95** with full instructions

### INHERITANCE

Have you ever wondered what you'd do if you came into some money? Would you be able to invest it and watch it grow, or maybe start a small business and become a millionaire. With Inheritance you have the chance to find out.

*"A great game, really two games for the price of one"*

*Micro User, June '83*

**£5.95**

with full instructions

### WORLD TRAVEL GAME

A game for 1 or 2 players. Rush around the world collecting souvenirs. Keep your head and try to avoid the dangers inherent in such a journey.

*"Exciting, competitive and even educational – not to be missed"*

**£6.95**

with world map and full instructions

★ **Special Offer to Micro User readers**  
**ALL 3 GAMES £16.95**

**SIMON W. HESSEL SOFTWARE**

(Dept. B1)

15 Lytham Court, Cardwell Crescent, Sunninghill, Berks.

Telephone: Ascot 25179

24HR DESPATCH – PLEASE ADD 30p P & P  
– UNLIMITED GUARANTEE –

# Simonsoft

Specialists in High Quality Software for  
the BBC Microcomputer

**DISASSEMBLER (A/B)** – a 'smart' disassembler that will generate fully labelled assembly listings of any machine code program – data is automatically differentiated from code and displayed together with its ASCII equivalent – the assembly listing can be saved in \*EXEC format and subsequently incorporated into user programs – supplied with full instructions.  
Without doubt the most powerful and flexible disassembler available  
Disassembler ..... £7.95

**EMULATOR (B)** – a new concept in machine code programming tools! Emulator is a machine code INTERPRETER which allows you to write and debug machine code as easily as BASIC – fully compatible with disassembler so that disassembled programs can be altered and 'emulated' – features single step, breakpoints register display, edit modes, data display mode etc etc – since the machine code is interpreted there is full protection from errors.  
Probably the most useful machine code programming tool.  
Emulator ..... £8.45

**BASIC GOODIES (A/B)** – a set of useful BASIC debugging routines saved in \*EXEC format and fully documented – includes PROC/FN LISTER which lists the lines where procedures and functions are defined together with name, parameters etc – VARIABLE LISTER displays the current values of all or selected variables; very useful for debugging and demonstrations – SUPER REPORT intercepts BASIC errors and returns the message in a string variable so that error messages can be more flexibly reported – and more besides.  
Basic Goodies ..... £5.95

Prices are fully inclusive (for disc version add £3.00 and state single or double density)

All programs are fully guaranteed and OS 0.1 to 1.2 compatible.  
DEALER ENQUIRIES WELCOME

# Simonsoft

Front Street, Topcliffe, North Yorkshire, YO7 3RJ.

NEW

NEW

BBC  
32K



## EDUCATIONAL SOFTWARE

LINDEN LEA, ROCK PARK,  
BARNSTAPLE, DEVON. EX32 9AQ.  
TEL: (0271) 45566

### AT LAST! GOOD EDUCATIONAL SOFTWARE

We think we've got it right. No doubt you'll tell us  
if we haven't.

**SPACEX**  
£10

An adventure/simulation project designed to engage a whole class in strategic planning, discussion, map work, role play and plenty of creative activity for weeks. As scientists stranded on the planet Persephone your children must work together if they are ever to leave. Manual of ideas and suggestions ensures the project will be an educational experience.  
Ages 10+

**WORLD  
Geography**  
£10

An extremely flexible package to promote atlas skills. Features a high-res. world map on which locations must be identified. Package includes 6 sample data files – Mountains, Oceans, Continents, Cities, Countries and Islands – BUT an easy-to-use filing program allows teachers (and children) to create new, or adapt existing, files.

**LINES  
and  
ANGLES**  
£5

A set of 2 programs designed for the younger child (but enjoyed by the older ones). LINES – teaches and tests the concepts of 'horizontal' and 'vertical'. ANGLES – teaches what is and isn't a right angle. Both use sound and graphic effects which your children will love. (Definitely not boring!) The long term effectiveness of these programs has been proved in the classroom. Ages 6+

All  
4 MAT  
programs

1. are classroom tested
2. use sound and graphics
3. are ideal for home use

P&P included  
for disc  
add £2

## INCREASE YOUR FIRE POWER !!!!

There you are, ZAPPING away with your laser, happily defending your planet when; suddenly – you're surrounded. Your one chance? a SMART BOMB. You reach for the keyboard – your spaceship nose dives and CRASH!!! – Wiped out. Later, on your cloud, playing your digital harp, you think "If only the SMART BOMB button had been next to the laser on the handset? I'd be alive today.", "If only the joystick had sprung back to centre at least I'd be still up there fighting."  
NOW!! TO SAVE THE WORLD. THE NEW DELTA 14 RANGE OF HANDSETS FROM VOLTMACE.



Used for years by DATABASE video game owners these handsets have sprung return, nylon coated steel joysticks with graphite wiper potentiometers for longer life and SM00-00-00-THER control, plus 12 pushbuttons with two extra fire buttons to share the wear.  
The DELTA 14 comes in two parts. One handset will plug into the 15 way "D" plug to give analogue joystick plus three button functions. The second part is the DELTA 14B/1 adapter box which plugs onto the 15 way "D" and connects to the user port. This gives use of all 12 buttons on the user port using a 3 x 4 strobed matrix. The eighth line is used to select a second joystick which can be plugged into the adapter box. Suggested software routines included with each handset.

DELTA 14 B JOYSTICK HANDSET FOR BBC £10.00  
DELTA 14 B/1 ADAPTER BOX & CABLE £13.00  
Including VAT P&P 95p



Cheques or postal orders to:

VOLTMACE LTD., Park Drive, Baldock, Herts (0462 894410)  
Callers welcome Monday to Friday. Trade quantity discounts.

"Maybe I could have a gatlin gun, firestreak missiles, photon torpedoes, warp drive, Hyperspace drive . . ."

## BBC Spectrum nascom

### GIANT ADVENTURE GAMES

- 1) **COLOSSAL ADVENTURE:** The classic mainframe game "Adventure" with all the original treasures & creatures + 70 extra rooms.
- 2) **ADVENTURE QUEST:** Through forest, desert, mountains, caves, water, fire, moorland and swamp on an epic quest vs Tyranny.
- 3) **DUNGEON ADVENTURE:** The vast dungeons of the Demon Lord have survived His fall. Can you get to their treasures first?

Every Level 9 adventure has over 200 individually described locations and is packed with puzzles – a game can easily take months to complete. Only sophisticated compression techniques can squeeze so much in! Each game needs 32K and costs £9.90

### BBC FORTH, FORTH TOOLKIT

"r q FORTH" runs on 16K or 32K BBC micros and costs £15. It:

- ★ follows the FORTH-79 STANDARD and has fig-FORTH facilities;
- ★ provides 260 FORTH words;
- ★ is infinitely extensible;
- ★ has a full-screen editor;
- ★ allows full use of the M.O.S;
- ★ permits use of all graphic modes, even 0-2 (just!);
- ★ provides recursion easily;
- ★ runs faster than BBC BASIC;
- ★ needs no added hardware;
- ★ includes a 70 page technical manual and a summary card;
- ★ has hundreds of users.

Level 9 Computing are pleased to announce a new toolkit for "r q FORTH" on 32K BBC micros. It costs only £10 and adds the following facilities to FORTH:

- ★ a 6502 assembler, providing machine-code within FORTH;
- ★ turtle graphics, giving you easy-to-use colour graphics;
- ★ decompiler routines, allowing the versatile examination of your compiled FORTH Programs;
- ★ the full double-number set;
- ★ an example FORTH program; and demonstrations of graphics;
- ★ other useful routines.

### nascom

**Extension Basic** ..... £15/£30 ROM  
Adds 30 new keywords to BASIC  
**Compression Assembler 2** ..... £12  
Small Source + high speed

**Asteroids** ..... m/c,g £7.90  
**Galaxy Invaders** ..... m/c,g £5.90  
**Missile Defence** ..... m/c,g £7.90  
**Super Gulp** ..... eb,g £4.90  
**5-games cassette** ..... misc £5.90  
(FULL RANGE IN CATALOGUE)

ALL PRICES INCLUDE P & P AND VAT. All programs are in stock and will be sent within 2 days of receipt. Please send order or SAE for catalogue, describing your micro, to:

### LEVEL 9 COMPUTING

Dept U, 229 Hughenden Road, High Wycombe, Bucks. HP13 5PG

# Fruities listing

From Page 60

```

10 PROCinit
20 ONERRORPROCerror
30 REPEAT
40 *FX12,0
50 *FX15,1
60 *FX4,1
70 REPEAT:MODE7:PROChEader:PROctitl
es
80 TIME=0:AZ=0:REPEATZ=INKEY(1):UN
TILAZ=89DRAZ=78ORTIME>3000
90 IFAZ=89PROCinstruct:ELSEIFTIME>3
000:MODE2:PROCscores
100 UNTILAZ=78
110 MODE2:VDU23;8202;0;0;0;19,4,1;0;
120 PROCscreen:PROCmove(0)
130 *FX11,1
140 *FX12,1
150 REPEAT
160 PROCmanmove
170 IFPOINT(XZ+32,YZ-24)=SZPROCdead
180 *FX15,1
190 PROCaliens(YZ)
200 IFPOINT(XZ+32,YZ-24)=SZPROCdead
210 IFNOZ=OPROCSheet
220 PROCoxygen
230 UNTILMANZ<=0
240 UNTIL FALSE
250 END
270 DEFPROCmanmove
280 KZ=INKEY(0):IFKZ=-1ENDPROC
290 IFKZ=32PROCdig:ENDPROC
300 IFKZ=47XZ=XZ+64:NCARZ=7
310 IFKZ=46XZ=XZ-64:NCARZ=8
320 IFXZ>1216XZ=1216ELSEIFXZ<0THENXZ
=0
330 KZ=KZAND&DF
340 IFKZ=65ANDPOINT(XZ+32,YZ+6)=RZY
=YZ+32:NCARZ=12:PROCmove(1):ENDPROC:EL
SEIFKZ=65ENDPROC
350 IFKZ=90ANDPOINT(XZ+32,YZ-42)=RZY
Z=YZ-32:NCARZ=12:PROCmove(1):ENDPROC:EL
SEIFKZ=90ENDPROC
360 PROCmove(1):IFPOINT(XZ+36,YZ-58)
=SZYZ=YZ-32:PROCmove(0):PROCdead:ENDPR
OC
370 IFPOINT(XZ+36,YZ-58)=OPROCFall
380 ENDPROC
400 DEFPROCmove(LX):VDU5:6COL3,3:MOV
EOLDXZ,OLDYZ:VDU227+OCARZ:MOVEXZ,YZ:VD
U227+NCARZ:SOUND&10,-10,6,LX:OLDXZ=XZ:
OLDYZ=YZ:OCARZ=NCARZ:VDU4:ENDPROC
410
420 DEFPROCdig:IFNCARZ=7PROCdig_righ
t:ELSEIFNCARZ=8PROCdig_left
430 ENDPROC
440
450 DEFPROCdig_right:IFPOINT(XZ+65,Y
Z-12)=RZORPOINT(XZ,YZ-40)=10ORPOINT(XZ

```

```

+160,YZ-36)=0ORPOINT(XZ+96,YZ-60)=0ORP
OINT(XZ+96,YZ)=-1ENDPROC
460 AZ=POINT(XZ+92,YZ-38):BZ=POINT(X
Z+92,YZ-56):NCARZ=9:PROCmove(0):SOUND&
10,-15,4,1:6COL0,8:VDU5;10;9;127
470 IFBZ=SZPROCKill_right
480 IFAZ=0ANDBZ=0VDU238:SOUND0,15,6,
1
490 IFAZ=0ANDBZ=8VDU231
500 IFAZ=8ANDBZ=8VDU230
510 NCARZ=7:PROCmove(0):ENDPROC
520
530 DEFPROCdig_left:IFPOINT(XZ-1,YZ-
12)=RZORPOINT(XZ,YZ-40)=10ORPOINT(XZ-9
6,YZ-36)=0ORPOINT(XZ-32,YZ-60)=0ORPOIN
T(XZ-10,YZ)=-1ENDPROC
540 AZ=POINT(XZ-48,YZ-38):BZ=POINT(X
Z-36,YZ-56):NCARZ=10:PROCmove(0):SOUND
&0010,-15,4,1:6COL0,8:VDU5;10;8;127
550 IFBZ=SZPROCKill_left
560 IFAZ=0ANDBZ=0VDU238:SOUND0,-15,6
,1
570 IFAZ=0ANDBZ=8VDU231
580 IFAZ=8ANDBZ=8VDU230
590 NCARZ=8:PROCmove(0):ENDPROC
600
610 DEFPROCFall:NCARZ=12:SOUND&12,3,
230,1:REPEAT:YZ=YZ-16:PROCmove(0):UNTI
LPOINT(XZ+30,YZ-58)=8ORPOINT(XZ+30,YZ-
33)=10ORPOINT(XZ+32,YZ-42)=RZORPOINT(X
Z+36,YZ-58)=SZ
620 IFPOINT(XZ+36,YZ-58)=SZSOUND&001
3,0,0,1:YZ=YZ-32:PROCmove(0):PROCdead:
ENDPROC
630 SOUND&12,0,0,1:SOUND0,-15,4,1:NC
ARZ=13:PROCmove(0):ENDPROC
640 DEFPROCoxygen:OZ=OZ-2:PRINTTAB(7
,31);OZ;" ";IFOZ<=0PROCdead
650 ENDPROC
660
670 DEFPROCdead:NCARZ=12:SOUND&12,2,
170,60:FORN=1TO20:YZ=YZ+32:PROCmove(0)
:YZ=YZ-32:PROCmove(0):SOUND&11,4,N=12,
60:SOUND&10,2,7,60:NEXT:VDU5;127;232;4
:FORN=1TO3000:NEXT:MANZ=MANZ-1:IFMANZ<
=0PROCend:ENDPROC:ELSEQZ=QZ-1:PROCShee
t
680 ENDPROC
690
700 DEFPROCend:VDU4:COLOUR128:COLOUR
6:PRINTTAB(7,14);"THE END";FORN=1TO6
0:VDU19,8,RND(7);0;FORN=1TO70:NEXT:SO
UND&11,4,RND(N),60:NEXT:VDU19,8,2;0;P
RINTTAB(7,14);FORN=1TO7:COLOURN:VDU22
7:SOUND&10,2,6,60:FORT=1TO599:NEXT:NEX
T:TIME=0
710 REPEATUNTILTIME>100:IFHI<SCZTHE
NHIZ=SCZ
720 ENDPROC
730

```

```

740 DEFPROCaliens(ZZ):LOCALXZ,YZ:NZ=
NZ+1:IFNZ>QZNZ=1
750 IFSZ(NZ)=0ENDPROC
760 XZ=AXZ(NZ):YZ=AYZ(NZ):VZ=MXZ(NZ)
:WZ=MYZ(NZ):AZ=POINT(XZ+2,YZ+6):BZ=POI
NT(XZ+2,YZ-42):CZ=POINT(XZ+30,YZ-48):D
Z=POINT(XZ+36,YZ-58)
770 IFWZ>0ANDAZ=RZYZ=YZ+WZ
780 IFWZ<0ANDBZ=RZYZ=YZ+WZ
790 IFCZ=0ANDDZ=8PROCfill:ENDPROC
800 IFCZ=0ANDDZ=0PROCdrop:ENDPROC
810 IFYZ=92ORYZ=252ORYZ=412ORYZ=5720
RYZ=732ORYZ=892PROClevel
820 AXZ(NZ)=XZ:AYZ(NZ)=YZ:MXZ(NZ)=VZ
:MYZ(NZ)=WZ:PROCmove:ENDPROC
830
840 DEFPROClevel:XZ=XZ+VZ:IFXZ<0VZ=6
4:XZ=64ELSEIFXZ>1216VZ=-64:XZ=1216
850 IFZ<YMWZ=-32
860 IFZ>YMWZ=32
870 IFYZ=ZMWZ=(2-RND(3))*32
880 ENDPROC
890
900 DEFPROCfill:AYZ(NZ)=AYZ(NZ)-16:P
ROCmove:SOUND0,-15,2,3:AYZ(NZ)=AYZ(NZ
)+16:PROCmove:6COL0,8:VDU5;8;10;228;4
:ENDPROC
910
920 DEFPROCdrop:AYZ(NZ)=AYZ(NZ)+16:P
ROCmove:AYZ(NZ)=AYZ(NZ)-16:PROCmove:
SOUND&13,4,50,60:LX(NZ)=LX(NZ)+1:IFLZ(
NZ)=20THENIFPOINT(XZ-2,YZ-6)=8ORPOINT(
XZ+74,YZ-6)=8PROCcrawl_out:ENDPROC
930 IFPOINT(XZ-2,YZ-6)=8ORPOINT(XZ+7
4,YZ-6)=8ENDPROC
940 SOUND&11,0,130,1:SOUND&10,-15,7,
6:AYZ(NZ)=AYZ(NZ)-32:PROCmove:ENDPROC
950
960 DEFPROCcrawl_out:AYZ(NZ)=AYZ(NZ)
+32:PROCmove:FORN=100TO250STEP10:SOU
ND&11,0,UZ,1:SOUND&10,-15,7,1:NEXT:6CO
L0,8:VDU5;8;10;228;4:LX(NZ)=0:ENDPROC
970 DEFPROCKill_right:LOCALNZ:FORN=
1TO3:IFXZ+64=AXZ(NZ)ANDYZ-32=AYZ(NZ)PR
OCafall
980 NEXT:ENDPROC
990
1000 DEFPROCKill_left:LOCALNZ:FORN=1
TO3:IFXZ-64=AXZ(NZ)ANDYZ-32=AYZ(NZ)PR
OCafall
1010 NEXT:ENDPROC
1030 DEFPROCmove:VDU5:6COL3,SZ:MOVEO
LDAXZ(NZ),OLDAYZ(NZ):VDU227:MOVEAXZ(NZ)
,AYZ(NZ):VDU227;4:OLDAXZ(NZ)=AXZ(NZ):
OLDAYZ(NZ)=AYZ(NZ):ENDPROC
1050 DEFPROCFall:LOCALXZ,YZ:VDU5;9;1
27;228:IX=100:6COL3,SZ:VDU8;227:SOUND&
11,3,255,60:SOUND&10,-15,7,60

```

## B.B.C. DESKTOP CONSOLE



TIDY UP YOUR B.B.C. COMPUTER.  
TELEVISION - CASSETTE RECORDER - SINGLE OR DOUBLE DISC DRIVE

ALL ACCOMMODATED ON A PROFESSIONAL CONSOLE. THIS ROBUST GLASS FIBRE CONSOLE ALSO HAS PROVISION FOR 10 CASSETTES AND A FOOLSCAP NOTEPAD.  
IDEAL FOR USE IN SCHOOLS AND COLLEGES  
SIZE: 27½" (700mm) x 31½" (800mm)

A WORTHWHILE INVESTMENT AT  
£39.95 INCLUSIVE OF P & P

Cheque or P.O. to:-  
LAMPLAS (DURHAM) LTD,  
7/9 RAMSAY STREET,  
HIGH SPEN,  
ROWLANDS GILL,  
TYNE & WEAR.

DEALER ENQUIRIES INVITED.

ORIC CONSOLES AVAILABLE NOW - £36.95

## FOR THE BBC MICROCOMPUTER

### TINY PASCAL

PASCAL-T is a 16K Eprom program capable of compiling source PASCAL into a compact very fast threaded-interpreters-code. Full editor and disc support are included and the program is supplied with comprehensive documentation.

Price £59.00 + VAT

### X CAL

An expert computer-aided learning package in 16K Eprom and support disc. No programming skill required to construct learning sessions as the program is screen driven. Facilities include text pages, graphics and histograms.

Price £65.00 + VAT

### FORTH

FIG-FORTH in 8K Eprom together with manual.

Price £34.72 + VAT

### LOGO-FORTH

A 16K Eprom program introducing this very powerful but extremely friendly Turtle-graphics language. Users also have full access to the FIG-FORTH support nucleus. Full documentation is included.

Price £59.00 + VAT

Retail/Mail Order/Dealer Enquiries to:-

### H.C.C.S. Associates

533 Durham Road, Low Fell, Gateshead,  
Tyne & Wear NE9 5EY. Tel: (0632) 821924

Retail sales also at:-

H.C.C.S. Microcomputers  
122 Darwen Street, Blackburn, Lancs.  
Tel: (0254) 672214

## EDUCATIONAL SOFTWARE

For children ages 4-11

# EDUCARE'S 50

Fifty high-quality programs for primary education  
Strongly recommended by educational authorities

on the

# ZX81

with

# SPECTRUM SUPPLEMENT

£5.95 Paperback  
122 pages

(All programs suit 1K ZX81)

on the

# BBC

## MICRO

(Model A and Model B)

WITH COLOUR, SOUND AND  
OTHER ENHANCEMENTS

PROGRAMS WRITTEN IN  
STRUCTURED FORM

£7.95 Paperback  
110 pages

**NEW**

These programs cover a wealth of basic concepts every child will meet in primary education. They are produced by professional educators and have been thoroughly tested in a primary school. Designed to go beyond drill & practice they promote learning through interaction and discovery. Programs range from counting and simple arithmetic to ones dealing with volume, balance and direction, mostly in form of games. Each program is short but powerful and comes with full documentation.

To: EDUCARE  
139a Sloane St.  
London  
SW1X 9AY

Please send... copies Educare's 50 on ZX81/Spectrum.  
... copies Educare's 50 on BBC Micro.

I enclose cheque/postal order for £.....  
Name.....  
Address.....

Let your child benefit early - Send now

BBC

## BBC Micro Utilities from Qualitysoft

00. INSTRUCTOR ... Text in BASIC PRINT statements containing full instructions, with examples, on how to use the following programs.
01. VARLISTER ... Lists all variables currently held in memory along with their values, with arrays only the variable name is displayed.
02. FINDER ... Search for a specific string of text in a BASIC program and display the whole line containing every occurrence.
03. REPLACER ... Search for a specific string of text in a BASIC program and replace every occurrence with another.
04. DESPACER ... Carefully removes unnecessary spaces within a BASIC program except text in REMs, quotes, assembler comments and some special cases.
05. DECOM ... Removes all REMs and assembler comments in a BASIC program including trailing colons and spaces.
06. STRINGSORT ... An extremely fast string array sort. Sorts arrays of any dimension typically taking 1.75 secs for 1000 strings in reverse order.
07. INTEGRSORT ... Some as above but with integers and taking 1.25 secs for 1000 items in reverse.
08. RELOCATOR ... A relocatable machine code relocater that allows machine code to run in another area of memory.
09. NEATLISTER ... Lists entire BASIC programs neatly. Formats for REPEAT, ELSE, colons; and particular assembly language.
10. MOVEMEMORY ... Moves any area of memory to anywhere else in memory even if it overlaps itself.
11. ROTATOR ... Performs rotation formula on specific BASIC variables for a specific angle for use in drawing shapes.
12. POLYGON ... Draws or fills a whole or part of a regular polygon any height or width with up to 255 sides at any angle anywhere on the screen.

Programs 01 to 11 are all less than 256 bytes long.

Programs 02, 03, 09, 11, 12 are written specifically for the 1981 version of BASIC. Otherwise all programs are guaranteed to run on any model.

All 12 excellent quality, efficient, easy to use machine code programs on cassette, amazing value at only £4.00 inc.

Immediate despatch!

Available from:

Qualitysoft, 4 James Close, Bridgend,  
Glamorgan CF32 9SJ.

# BBC

Your Official Thames Valley Dealer

Contact us for all your BBC  
Microcomputer requirements.

We supply:

**Service, Support, Demonstrations,  
Advice, Sales.**

Full range of Hardware and Software  
available from:

## P.J. MICROSYSTEMS

14 Wood End Crowthorne, Berks.  
RG11 6DQ.  
Telephone: (0344) 772351

## TOP QUALITY PRINTERS! ROCK BOTTOM PRICES!

EPSON RX80 £258 + VAT SHINWA CP80 £258 + VAT  
EPSON FX80 £358 + VAT STAR 510 £258 + VAT  
EPSON MX100 £419 + VAT STAR 515 £368 + VAT

We also have large stocks of sundries including  
ribbons, fanfold and roll paper, continuous labels, dust  
covers, etc.

For **FREE BROCHURE** and **DISCOUNT ORDER  
FORM** write now to:

**Datatech Ltd (TMU)**  
3 Bramhall Close, Timperley, Altrincham,  
Cheshire WA15 7EB.

## CONTEX

Adult Educational Software for the BBC Computer

**TYPING TUTOR** 32K  
Specifically designed for the BBC micro the 90 smoothly graded lessons and the  
free form option teach and encourage fast touch typing. Intelligently checks for  
errors, monitors progress, times and makes recommendations. Audio key feedback,  
metronomic pacing, many user configurable options, full instruction booklet  
included. £9.99 inc.

**SPREADSHEET** 32K  
A complete and versatile 'calc' program and tutorial. Models containing over 1000  
elements can be built using up to 26 columns and 99 rows. Equations, constants or  
text in any element. Emphasis on ease of use includes copy, row/col insert,  
delete, totals, headers, variables, functions, row colours, save and restore.  
Tutorial, application examples and documentation of all the Basic program for  
those who wish also to explore the design. £7.99 inc.

Cassette based, professional software. Fast delivery. Deduct £1.50 if both  
programs ordered together.

Cheques/P.O. payable to

**"Contex Computing" (B8)**  
15 Woodlands Close, Cople, Bedford  
MK44 3UE.

## Give your BBC Micro a REAL voice.

With the Voxbox voice digitiser.

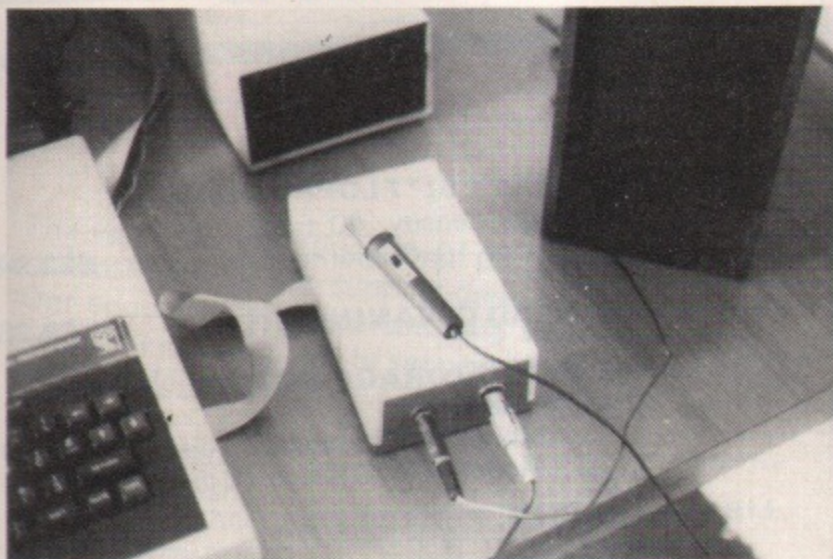

Normal human voice can now be stored on disc and  
accessed from your own programs. Store words or  
phrases in English or any other language.  
The Voxbox comes complete with a speaker, microphone  
and full operating software to enable you to build your  
own voice files. Just plug into the User Port.

It speaks for itself.

**Multiplex Computer Services**  
250, Eastern Road, Brighton BN2 5TA.  
Tel: (0273) 606860

## PROGRAM TO SELL?

Maybe it's an idea you've not had  
before. It could be financially well worth  
your while finding out.

Send us your program for professional  
evaluation. If it stands up then it's good  
- very good. And it's our job to see it  
reaches the biggest potential market -  
bringing YOU continuing royalty  
payments.

We're specially interested in:

- EDUCATIONAL
- BUSINESS
- EXCEPTIONAL GAMES

for the B.B.C. Micro.

Please send demonstration tape + brief  
documentation + RAM size and  
peripherals required + SAE for reply, to:

'Bitabyte'  
(Dept SEB),  
5 Seabridge Road,  
Newcastle, Staffs. Tel: (0782) 614888

# Wilmslow Micro

## THE BBC MICRO COMPUTER SYSTEM



AVAILABLE FOR IMMEDIATE DELIVERY

- BBC Model B (latest specification) OS 1.2 **£399\***
- BBC Model B with Pace Disc Interface **£509\***  
*(fitted free in our own workshops)*
- Pace Disc Interface Kit **£110**  
*(with full instructions)*

Fitting service available. Please phone for details.

\* Carriage £8

## For all your BBC Micro needs

### TURN YOUR BBC 'B' INTO A HIGH QUALITY WORD PROCESSOR

SPECIAL PACKAGE DEAL  
**£688.14**  
SAVE  
**£104.25**

All you need is:

- Wordwise word processor chip **£44.85**
  - Kaga green screen monitor **£130.64**
  - Silver Reed electronic typewriter with interface **£566.95**
  - Data cassette recorder (guaranteed to work with BBC) **£49.95**
- TOTAL £792.39**

All items available separately.  
Carriage: Monitor £8. Typewriter £8.  
Cassette Recorder £2. Chip 50p.

## AT LAST!

A data cassette recorder that works with the BBC Micro



Supplied complete with BBC Lead, Mains Adaptor and Instructions.

**£49.95**  
inc. P & P

## ★ SPECIAL OFFER ★

### CUMANA DISC DRIVES

- Single (100K) **£205**
- Dual (total 200K) **£402**

Both offers complete with BBC lead, power supply, formatting disc and manual.

- **FREE** – 2 Datalife discs with each order ●

## ACCESSORIES

### VERBATIM VEREX 5¼" FLOPPY DISCS.

Single sided, single density, 40 track (MD200-01) Box of 10. Guaranteed for 1 year. **£22.94**

VERBATIM HEAD CLEANING KIT **£9.33**

### LOCKABLE DISC STORAGE BOXES

Strong, attractive, secure.

Model ACP 35 (holds 35 discs) **£20.00**

Model ACP 70 (holds 70 discs) **£26.00**

LIBRARY BOXES. Holds 10 discs.

Great value at **£1.96**

### C12 COMPUTER GRADE BLANK CASSETTES.

Special offer: 11 for **£5.00**

DUST COVERS. Smart durable, fits BBC and Epson FX80 Printer **£3.25**

JOYSTICKS Fully proportional, compact, handy size. **Per Pair £16.50**

BB KEY Simple, effective way of labelling your function keys. **£1.50**

## UNBEATABLE PRINTER OFFER!

CENTRONICS 737-2 Parallel Printer

- Dot Matrix Printer
- 100cps at 10 cpi monospaced (non-graphics)
- Friction or 9½" fixed tractor paper feed complete with BBC lead.

**£250**

While stocks last (Carriage £8)





# Fruities listing

From Page 93

```

1060 REPEAT:AYZ(NZ)=AYZ(NZ)-32:YZ=AXZ
(NZ):YZ=AYZ(NZ):IFPOINT(XZ-2,YZ)=BORPO
INT(XZ+74,YZ)=86COLO,8:VDU5;8;10;228:I
Z=IZ+100
1070 PROCmove:UNTILPOINT(XZ+30,YZ-58
)=BORPOINT(XZ+30,YZ-33)=100RPOINT(XZ+3
2,YZ-42)=RZ:IFPOINT(XZ+32,YZ-42)=RZAYZ
(NZ)=AYZ(NZ)-32:AXZ(NZ)=AXZ(NZ)+64:PRO
Cmove
1080 FORN=1TO5:SOUND&11,0,0,1:NEXT:IF
IZ>FZPROCsplat:ELSE SOUND&11,1,100,200
:SOUND&10,2,7,200
1090 VDU4:ENDPROC
1110 DEFPROCsplat:SZ(NZ)=0:SOUND&11,1
,200,90:SOUND&10,2,7,60:VDU5;127;:6COL
3,SZ:PRINT;IZ;:FORT=1TO500:NEXT:VDU8;8
;8;:PRINT;IZ;:VDU4:SCZ=SCZ+IZ:PRINTTAB
(5,1)"SCORE:";SCZ;:IZ=0:LZ(NZ)=0:NOZ=N
OZ-1:ENDPROC
1130 DEFPROCinit:DIMSET(6),MXZ(3),MYZ
(3),LVZ(3),AXZ(3),AYZ(3),OLDAXZ(3),OLD
AYZ(3),LZ(3),RZ(3),SZ(3):HIZ=1000
1140 ENVELOPE1,1,1,-3,1,20,20,20,0,0,
0,0,0,0:ENVELOPE2,130,0,0,0,0,0,127,
-1,0,0,126,0:ENVELOPE3,128,-1,0,0,200,
0,0,127,0,0,0,126,0:ENVELOPE4,1,3,-2,3
,10,10,10,127,-1,0,0,126,0
1150 VDU23,227,66,36,36,126,219,255,2
55,126
1160 VDU23,228,123,123,123,0,222,222,
222,222
1170 VDU23,229,129,129,129,255,129,12
9,129,255
1180 VDU23,230,0,1,67,0,206,222,222,2
22
1190 VDU23,231,0,0,0,0,128,194,198,22
2
1200 VDU23,232,16,16,124,16,16,56,126
,255
1210 VDU23,234,96,108,72,120,64,64,64
,96
1220 VDU23,235,6,54,18,30,2,2,2,6
1230 VDU23,236,96,96,64,96,80,76,66,9
6
1240 VDU23,237,6,6,2,6,10,50,34,6
1250 VDU23,238,0,0,0,0,0,0,0,0
1260 VDU23,239,66,90,74,126,24,60,36,
36
1270 VDU23,240,66,90,74,126,24,60,36,
36
1280 ENDPROC
1300 DEFPROCscreen:COLOUR138:VDU19,5,
0;0;28,0,2,19,1:CLS:VDU28,0,31,19,30:C
LS:MANZ=3:RZ=5:VDU26:SCZ=0:PRINTTAB(5,
1);"SCORE:";QZ=0:FZ=100:SZ=4:NOZ=0:HZ
=0:VDU19,8,2;0;19,9,3;0;19,10,6;0;:PRO
Csheet:ENDPROC
1320 DEFPROCsheet:PRINTTAB(0,1);STRIN

```

```

G$(MANZ,CHR$(234));" ";QZ=QZ+1:IFQZ>
3THENQZ=1:FZ=FZ+100:IFFZ>500FZ=500
1330 HZ=FZDIV100:IFHZ=4HZ=5ELSEIFHZ=>
5HZ=6
1340 RZ=HZEOR4:VDU19,SZ,HZ;0;:NOZ=QZ:
FORN=1TOQZ:SZ(N)=1:NEXT
1350 VDU19,RZ,0;0;:COLOUR128:COLOUR8:
VDU24,0;64;1279;895;:CL6:VDU26:PROCbri
cks:VDU19,RZ,5;0;:COLOUR138:COLOUR0:OZ
=2000:PRINTTAB(0,31);"OXYGEN ";OZ;:PRO
Cadders
1360 XZ=256:YZ=252:OLDXZ=XZ:OLDYZ=YZ:
NCARZ=7:OCARZ=11:OZX=2000:PROCmove(0):
PROCpositions:COLOUR138:COLOUR7:ENDPRO
C
1380 DEFPROCpositions:AXZ(1)=256:AXZ(
2)=320:AXZ(3)=64:FORN=1TO3:AYZ(N)=732:
OLDAXZ(N)=0:OLDAYZ(N)=0:LVZ(N)=1:NEXT:
MXZ(1)=64:MXZ(2)=-64:MXZ(3)=-64:MYZ(1)
=32:MYZ(2)=-32:MYZ(3)=32:NZ=0:ENDPROC
1400 DEFPROCbricks:BR$=STRING$(20,CHR
$(228)):FORN=5TO25STEP5:PRINTTAB(0,N)B
R$:NEXT:ENDPROC
1420 DEFPROCadders:VDU19,RZ,0;0;:COL
OURRZ:COLOUR128:FORLV=4TO24STEP5:REPEA
T:SET(0)=0:FORN=1TO5:SET(N)=RND(TIME)A
ND1:SET(0)=SET(0)+SET(N):NEXT:IFLV<>24
THENNo=3ELSENo=2
1430 UNTILSET(0)=No:Z=0:FORPUS=2TO18S
TEP4:Z=Z+1:IFPUS=18PUS=17
1440 IFSET(Z)=1PROCadder
1450 NEXTPUS,LV:VDU19,RZ,5;0;:ENDPROC
1460
1470 DEFPROCadder:LD=0:PRINTTAB(PUS,LV
)"":REPEAT:VDU229;10;8:LD=LD+1:UNTILL
D=6:ENDPROC
1490 DEFPROCinstruct:PROCheader
1500 PRINT""Once upon a time there w
as a garden..."And in this garden gr
ew a patch of wild and mysterious frui
t..."So strange was this fruit that ma
ny""craved for a taste.However when a
nyone came near to it, it would get u
p and"
1510 PRINT"devour them!"Are you a
brave enough soul to travel into the
";CHR$(130);"BBC FRUITY-PATCH ??"If
so then follow me"
1520 PRINT""PRESS SPACE TO CONTINUE"
1530 REPEATUNTILINKEY(1)=32
1540 PROCheader
1550 PRINT""Using your skill and cun
ning you must outrun the little begg
ars.""You start each sheet with a new
network of";CHR$(133);"ladders";CHR$(
135);"and";CHR$(130);"paths";CHR$(135)
;,"and as your skill"
1560 PRINT"increases you will eventua
lly meet the"
1570 PRINT'CHR$(129);CHR$(136);"

```

```

ULTIMATE little horror"
1580 PRINT"that can only be killed by
being droppedthrough";CHR$(131);"FIVE
WHOLE LEVELS"
1590 PRINT""PRESS SPACE TO CONTINUE"
1600 REPEATUNTILINKEY(1)=32
1610 PROCheader
1620 PRINT""Just before I go, here ar
e a few clues.":PRINTCHR$(129);"BEWARE
";CHR$(135);"DON'T STAY in the same pl
ace""too long.""Dig holes fast and d
eep and hit the""beasts before they g
et time to crawl""out."
1630 PRINT"Oh and by the way watch yo
ur";CHR$(134);CHR$(136);"OXYGEN";CHR$(
135);CHR$(137);"ifit runs out you lose
a life."
1640 PRINT'CHR$(136);CHR$(130);"
GOOD LUCK""PRESS SPACE TO CON
TINUE"
1650 REPEATUNTILINKEY(1)=32
1660 PROCheader:PROCTitles
1670 ENDPROC
1690 DEFPROCheader
1700 CLS:VDU23;8202;0;0;0;
1710 PRINTTAB(0,4);:VDU141;132;157;13
0:PRINTTAB(12,4)"WILD ";:VDU136:PRINT
"FRUITIES"
1720 PRINTTAB(0,5);:VDU141;130;157;13
1:PRINTTAB(12,5)"WILD ";:VDU136:PRINT
"FRUITIES"
1730 PRINTTAB(12,8);CHR$(141);"HI:";C
HR$(136);HIZ;:PRINTTAB(12,9);CHR$(141)
;"HI:";CHR$(136);HIZ;
1740 ENDPROC
1760 DEFPROCTitles
1770 PRINTTAB(11,6);:VDU128+RND(8):PR
INT"By Mark Smiddy"
1780 PRINTTAB(12,11)"A = UP";TAB(
12,13)"Z = DOWN";TAB(12,15)"> =
LEFT";TAB(12,17)"? = RIGHT";TAB(
11,19)"SPC = ";CHR$(136);CHR$(130);"D
IG"
1790 PRINTTAB(5,22)"NEED INSTRUCTIONS
(Y/N);CHR$(137)
1800 ENDPROC
1820 DEFPROCscores:VDU23;8202;0;0;0;:
PROCscreen:LOCALNZ,N:COLOUR128
1830 FORNZ=5TO25STEP5:N=N+1:IFN=4N=5
1840 SZ(1)=1:*FX15,1
1850 COLOURN:PRINTTAB(3,NZ-1);CHR$(22
7);TAB(7,NZ-1);NZDIV5*100;:NEXT:TIME=0
:QZ=1:REPEATPROCaliens(RND(64)*25):UNT
ILTIME>30000RINKEY$(0)<>":VDU4:ENDPRO
C
1870 DEFPROCerror:IFERR=17ENDPROC
1880 *FX12,0
1890 *FX4,0
1900 MODE6:PRINT'':REPORT:PRINT" In
Line "ERL

```

# BBC MICRO IN MANCHESTER

All prices include VAT unless otherwise stated

BBC Model B Computer .....	£399
BBC Model B with Disc Interface .....	£469
BBC Model B with Disc Interface and VIEW .....	£528.90
BBC Model A Computer .....	£299
A to B Upgrade (including fitting) .....	£69
Disc Upgrade (including fitting) .....	£114
VIEW Word Processor .....	£59.90

**BBC  
COMPUTER  
HARDWARE**  
always in stock

## TEAC SLIMLINE DISC DRIVES

Including Cables, Formatting Disc, Disc Manual and 12 months guarantee. We have provided over 100 of this type of drive to personal users, educational establishments and companies, and there are probably around 1,000 BBC users of this extremely reliable disc drive.

It can also be twinned at a later date to give 200K.

100K – **£205** inc. VAT 400K – **£345** inc. VAT

Twin 100K's to give 200K **£389** inc. VAT

**BBC  
COMPUTER  
DISC  
DRIVES**  
always in stock

## ★ ★ MASSIVE RANGE OF GAMES ALWAYS IN STOCK ★ ★

### JUKI DAISYWHEEL

- Centronics interface
- Multi spacing
- Outstanding value
- True Daisywheel quality

**£458.85** inc. VAT

### AP100A Acorn Printer

- Centronics interface
- Several character sets
- Screen Dumps (free screen dump prog.)
- Double size
- Our best-selling printer

**£219** inc. VAT

### STAR DP510

- Centronics interface
- Top quality Dot Matrix
- Many character sets
- Screen Dumps
- Italics/Double Size
- Form and tractor feed
- True descenders

## WORD PROCESSING PACKAGE

100K Teac Drive .....	£205
VIEW Word Processor .....	£59.90
JUKI Daisywheel Printer .....	£458.85

~~£723.75~~

**OUR PRICE £699** inc. VAT

If you also require a BBC Micro please add  
£469 – includes DFS.

## DISC UPGRADE

100K Teac Drive .....	£205
Disc Interface .....	£114
	<u>£319</u>

**OUR PRICE £299** inc. VAT

## PROFESSIONAL SYSTEM

100K Teac Drive .....	£205
Acorn AP100A .....	£219

~~£424~~

**OUR PRICE £419** inc. VAT

**C ★ TECH** COMPUTERS

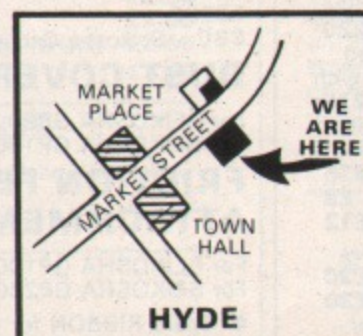

**184 Market Street,  
Hyde,  
Cheshire SK14 1EX.  
Tel: 061-366 8223**



EDUCATIONAL & BULK  
DISCOUNTS AVAILABLE

# WATFORD ELECTRONICS

CARDIFF ROAD, WATFORD, Herts, England

Tel: Watford (0923) 40588. Telex: 8956095 WAELEC

## BBC MICROCOMPUTER

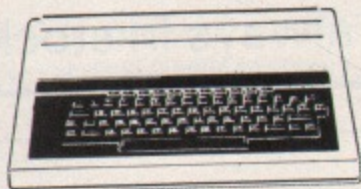

**BBC Model A – £260**  
**BBC Model B – £346**

**BBC Micro Model A to Model B**  
**UPGRADE Kits:**

Upgrade your Model A with our Upgrade Kits and save yourself £ s s s (Installation instructions supplied with every kit)

- BBC1 16K Memory (8 x 4816AP-3 100nS) **£16.00**
- BBC2 Printer User I/O Port **£6.98**
- BBC3 Disc Interface Kit **£85.00**
- BBC4 Analogue I/O Kit **£6.40**
- BBC5 Serial I/O Kit **£6.70**
- BBC6 Expansion Bus Kit **£6.10**
- Complete Upgrade Kit Mod. A to Mod. B **£43.00**

## Dust Cover for BBC Micro

(Protects your expensive Micro from foreign bodies)

## DISC DRIVES

### BBC COMPATIBLE

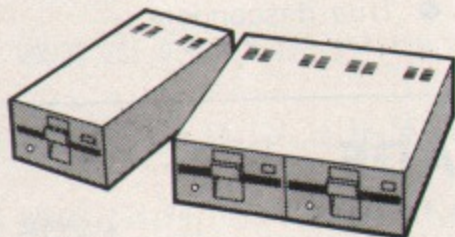

- **CS50A – TEAC** Cased with own Power Supply, S/S 40 track, 5 1/4", 100K **£175**
  - **CD50A – TEAC** Twin Cased with own PSU, S/S, 40 track, 5 1/4", 200K **£350**
  - **CS50E – TEAC** Single Cased with own PSU, S/S, 80 track, 5 1/4", 200K **£250**
  - **CD50E – TEAC** Twin Cased with own PSU, D/S, 80 track, 5 1/4", 400K **£475**
  - **CS50F – TEAC** Single Cased with own PSU, D/S, 80 track, 5 1/4", 400K **£299**
  - **CD50F – TEAC** Twin Cased with own PSU, D/S, 80 track, 5 1/4", 800K **£550**
  - **MITSUBISHI Slimline** – Uncased, double density. Double track, 5 1/4", 1 Megabyte, track density 96TPI, track to track access time 3mSec. Plugs directly to BBC Micro. **ONLY £220**
  - **SINGLE MITSUBISHI Slimline** – Cased with own PSU, DS/DD, 1 Megabyte. (400k with BBC) **£275**
  - **TWIN MITSUBISHI Slimline** Cased with own PSU, DS/DD, 2 Megabyte. (800K with BBC) **£535**
  - Single Drive Cable for BBC Micro **£8**
  - Twin Drive Cable for BBC Micro **£12**
- (5 year warranty on VERBATIM Diskettes)
- 10 Verbatim Diskettes, 5 1/4", S/S **£20**
  - 10 Verbatim Diskettes, 5 1/4", D/S **£30**
- (2 year warranty on WABASH Diskettes)
- 10 WABASH Diskettes, 5 1/4", S/S **£15**
  - 10 WABASH Diskettes, 5 1/4", D/S **£25**

## DISKETTE STORAGE

Attractive Continental designed, LOCKABLE Diskette Boxes. Strong plastic construction with lockable lid. Smoked acrylic top and cream base fitted with dividers and adhesive title strips for ease of filing.

- M-35 Holds up to 35 mini discs **£18** (carr. £1.50)
- M-85 Holds up to 85 mini discs **£24** (carr. £2)

## PLASTIC LIBRARY CASES

### for Disc Storage

- 5 1/4" (holds 10) **£2**
- 8" (holds 10) **£2.90**

## FLOPPY HEAD CLEANERS

Unless your office/home is dust free, you should clean heads at least once a week to avoid the risk of cross contamination. Simply apply the cleaner to one of the specially formulated cleaning discs, insert into the drive and initialise. If your system has no initialisation program then insert the disc and open and close the door 5 times.

**£22.50**

## BBC PRINTER

## GP100A



10" Tractor Feed, 80 columns, 30CPS Normal & Double width Char, Dot res graphics. Parallel Interface standard. **ONLY £175 (£7 carr.)**

## SEIKOSHA GP250X:

10" Tractor Feed, 80 columns, 60 CPS, normal and double – width/height characters, 128 characters with true descenders in ROM, 64 user definable characters in RAM (384 bytes) Programmed printing (80 bytes of memory) for storing your own print sequences, dot addressable graphics with repetitive graphics data printing, RS232 and Centronics parallel interfaces standard, paper empty function and buzzer, self test routine. All this for

**ONLY £235 (£7 carr.)**

## INTERFACES

- IEEE **£54.95**
- PET **£69.95**
- APPLE II **£69.95**
- RS232 **£69.95**
- BBC – Seikosha Cable **£11.00**

## DUST COVERS

- For SEIKOSHA GP80 **£3.75**
- For SEIKOSHA GP100/250 **£3.95**

## FRICION FEED ATTACHMENT

- For SEIKOSHA GP100 **£22**
- For SEIKOSHA GP250 **£22**
- Spare RIBBON for GP80 **£4.50**
- Spare RIBBON for GP100 **£4.95**
- Spare RIBBON for GP250 **£5.95**

## STAK-PAK

The unique computer program filing and storage system. Made of tough black plastic these compact drawer sections hold two cassettes each and lock together vertically to form miniature cabinets of any height. Each drawer section has two Agfa C12 Cassettes with labels plus external index card. Five twin Paks (10 Cassettes) **£6.00** (Postage £1.00)

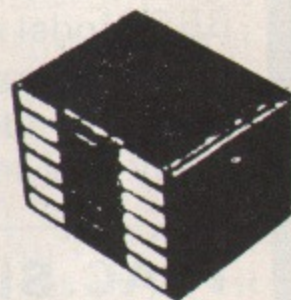

## NEC PC8023BE-C:



100 CPS, Bi-directional, logic seeking, 80 columns, 7x9 Dot Matrix head, true descenders on lower case, Superscript, subscript and underlining. Single sheet Friction or Tractor feed. Hi-resolution block graphics. All this for only **£320 (£7 carr.)**

## INTERFACES

- APPLE II **£64.95**
- BBC – NEC Interface Cable **£11.00**
- RIBBON **£6.90**

DUST COVER **P.A.O.**

## EPSON PRINTERS

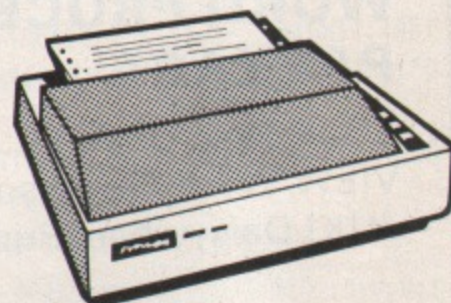

### Epson RX80

100 CPS, 9 x 9 matrix, dot addressable graphics, condensed and double width printing. Normal, Italic and Elite Characters. Tractor feed, 10" max width, bi-directional, logic seeking. Centronics Interface standard.

**ONLY £285 (£7 carr.)**

### Epson FX80

160 CPS, 11 x 9 matrix, proportional spacing, superscripts, subscripts, dot addressable graphics. Normal, Italic and Elite characters. Up to 256 user definable characters. Down loadable character set. Condensed and double width printing. Full proportional spacing. Four user defined margin positions. Tractor and Friction feed. 10" maximum width Bi-directional, logic seeking Centronics interface standard.

**ONLY £388 (£7 carr.)**

## Epson MX100

136 columns, 15" carriage, Tractor and Friction feed, 9 x 9 matrix. Speed 100 CPS, Bi-directional logic seeking. Normal, Condensed and Enlarged Characters. Also Emphasised, Double and Underlining modes. Hi-res bit image graphics. Superscript and subscript. Centronics interface standard.

**ONLY £425 (£7 carr.)**

## INTERFACES RX & FX PRINTERS

RS232	<b>£38.00</b>
RS232 plus 2K Buffer	<b>£75.00</b>
IEEE 488	<b>£70.00</b>
Parallel 2K	<b>£62.00</b>

## MX100 PRINTER

RS232	<b>£40.00</b>
RS232 plus 2K Buffer	<b>£60.00</b>
IEEE 488 (Interface Board)	<b>£43.00</b>
PET Cable	<b>£20.00</b>
BBC - Epson Interface Cable	<b>£11.00</b>

## RIBBONS

MX80 FT	<b>£4.75</b>
MX100	<b>£10.00</b>
FX80	<b>£4.75</b>
RX80	<b>£4.75</b>

## DUST COVERS

MX80 FT	<b>£4.50</b>
MX100	<b>£5.25</b>
FX80	<b>£4.95</b>
RX80	<b>£4.50</b>

## PAPER ROLL HOLDER **£12.50**

## LISTING PAPER

8½" x 9½" Fanfold paper plain or ruled (1000 sheets) **£7 (£1.50p carr.)**

15" Fanfold paper (1000 sheets) **£9 (£1.50p carr.)**

Teleprinter Roll (econo paper) **£4 (£1.50p carr.)**

## CASSETTE RECORDER & ACCESSORIES

Top quality Slimline, portable Cassette Recorder for Computer use. Mains/Battery, operated with counter.

**£24.00**  
(Carr. £1.50)

## CASSETTE LEAD

For our Cassette Recorder to BBC Micro **£2.00**

C12 Computer Grade **CASSETTES** in library cases. **40p**

## BEEBPEN

(BBC Wordprocessor in 4K ROM)

BeebPen has been written completely in machine code for the BBC Micro to facilitate maximum speed and number of functions. It is without doubt one of the best things to happen to BBC Micro since its launch. BeebPen has been designed to be as simple to use as possible while still retaining the maximum power and versatility. Numerous functions include right justification, block operations, text compression, full cursor control with on screen editing, a full set of printer options and editing in 80 column mode. BeebPen ROM plugs into one of the ROM sockets, no track cutting required.

**Special Introductory Offer: £32.00**

## MONITORS

### MICROVITEC 1431

14" Colour Monitor, RGB input. (as used in BBC programmes) FREE Interface Lead. **£249** (carr. £7)

Interface Lead for Sanyo **£8.**

**ZENITH 12" Green Monitor.**

Hi-resolution **£75 (£7 carr.)**



## MISCELLANEOUS CONNECTORS

	Plugs	Sockets
RGB (6 pin DIN)	<b>30p</b>	<b>45p</b>
RS423 (5 pin Domino)	<b>30p</b>	<b>40p</b>
Cassette (7 pin DIN)	<b>25p</b>	<b>65p</b>
ECONET (5 pin DIN)	<b>15p</b>	<b>25p</b>
Paddles (15 pin 'D')	<b>£1.10</b>	<b>£2.15</b>
Disc to BBC Power Plug 6pin	<b>70p</b>	
Disc Drive Power Plug 4pin	<b>60p</b>	

## BEEB PLOTTER

Watford Electronics' BEEB PLOTTER will work with 32K BBC Micro. Connects to Analogue port. The unique design makes it accurate and simple to use. The comprehensive booklet supplied, describes its use in details and shows some of the possible applications.

The special features include:-

- \* Works in all graphics mode and any colour selectable.
- \* Commands printed on Tablet and On-screen instructions.
- \* Special routines enable pictures to be quickly loaded from tape.
- \* Works with all operating systems and ECONET. Tape and Disc versions available.
- \* Large drawing area (32cms x 23cms).
- \* Maps, Pictures and Diagrams produced quickly and easily.
- \* Transparent tablet enables maps and diagrams to be copied directly from books.
- \* Commands include line, circles and rectangle drawings, infilling, full editing and an easy to use copy and move feature.
- \* Screen dump routines included for Seikosha and EPSON printers.
- \* Routines are included to allow user to incorporate pictures in their own programs.
- \* Designed by a professional teacher with educational uses in mind.

**ONLY £59 (£3 carr.)**

## EPROM PROGRAMMER for BBC MICRO

At last! - the EPROM Programmer for BBC Micro Computer from WATFORD ELECTRONICS that will suit both your pocket and all your requirements. Programs all popular types of EPROMS from 2K bytes up to 16K bytes - **2764 - 2516 - 2532 - 2564 - 2764 - 27128.**

This extremely powerful system is designed for your needs of TODAY & TOMORROW! - BBC Basic programs can be copied into EPROM and subsequently re-loaded faster than from a disc! Suitable for both hobbyist and professional users!

Just look at these features:

- **COMPLETELY SELF CONTAINED** - Housed in its own sturdy case - Uses its own Power Supply - Connects directly to the 1MHz Bus - Simple and Safe!
- **FULL SOFTWARE SUPPORT** - Comes complete with simple to use ROM based software - Facilities include Verification, Reading, Virgin Testing, Writing, Editing, Saving, Loading and more! NOTE!! - This software does NOT simply comprise hastily prepared routines to get you going, but is a professional, purpose designed applications package.
- **ACORN BUS COMPATIBLE** - Use of the 1MHz connection complies with all Acorn addressing recommendations - That means you can still add-on such things as the TELETEXT, IEEE 488 and PRESTEL Adaptors without having to disconnect everything.

You don't need just any Eprom Programmer - you need **WATFORD ELECTRONICS EPROM PROGRAMMER** System.

★ **Introductory Offer ★**

**ONLY £65 (£2 carr.)**

Price includes software in ROM and Manual)

## READY-MADE LEADS for BBC

CASSETTE LEADS 7 pin DIN Plug to 5 pin DIN Plug + 1 Jack Plug	<b>£2.00</b>
to 3 pin DIN Plug + 1 Jack Plug	<b>£2.00</b>
to 7 pin DIN Plug	<b>£2.50</b>
to 3 Jack Plugs	<b>£2.00</b>
<b>6pin DIN to 6 pin DIN Plug (RGB)</b>	<b>£2.50</b>
Monitor Lead, BNC to PHONO	<b>£3.00</b>

## BBC LIGHT PEN KIT

All parts available as per Acorn User's 'SHINE A LIGHT' Light Pen article.

Kit Price: **£9.95**

## BBC JOYSTICKS

Two versions available:

SINGLE: Player type	<b>£7.00</b> each
TWO Players type	<b>£11.50</b> per pair

## PRINTER LEAD 36"

Ready made printer lead to interface BBC Micro to EPSON, SEIKOSHA, NEC, etc., Printers.

**ONLY £11**

## 13 ROM SOCKET BOARD

Are you wondering where to fit new ROM based software inside your computer in addition to the BASIC, WORDPROCESSOR, DFS, and FORTH ROMS? Then our add-on 13 ROM Socket Board is the answer. Simply plugs into one of the four ROM sockets currently available in BBC Micro. There are only 4 solder connections to be made. Full instructions are supplied. Our 13 ROM SOCKETS BOARD enables the User to increase the Sideways ROM capacity from the basic four sockets on the main board up to the full SIXTEEN capable of being supported by current operating systems. In addition the board is designed with the facility to hold up to 16K RAM, which when switched into operation is automatically selected by any WRITE signal to the Sideways ROM area. This gives the User the ability to write a utility or language and upon pressing break have the utility or language up and running (new ROM software can be developed and tested in situ.)

The Board gives the User plenty of freedom to explore the possibilities of the new paged ROMs due in the coming months and offers them the chance to develop their own.

All essential lines are buffered and the Board meets or exceeds all timings for operation in the BBC Microcomputer.

Supplied ready-built and tested

**ONLY £35 (carr. £1)**

**NEW - NEW - NEW**

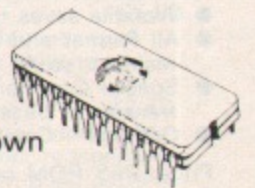

Watford Electronics' own

## BEEBMON

A ROM based machine code Monitor for the BBC Micro. It enables machine code programs to be debugged and altered easily and quickly. Being a ROM, its Commands are always readily available and occupy no USER memory.

The special features includes facilities like: TABULATE, MODIFY, FILL, COPY, COMPARE, SEARCH (Hex & ASCII), CHEKSUM, DISASSEMBLE, RE-LOCATE, SINGLE STOP, SET BREAK POINTS, SCREEN DUMP ROUTINE, DUMB TERMINAL and many more facilities.

**Introductory Offer: £18**

## TEX EPROM ERASERS

EPROMs need careful treatment to survive their expected lifetime. Rushing it could burn their brains out. So cop-out of this helter-skelter world; take it easy the TEX way and give your chips a well earned break. Cool, gentle and affordable. EPROMPT does it properly.

Two versions available:

● **EPROMPT EB** - The standard version. Erases up to 16 chips. **£32.00**

● **EPROMPT GT** - Erases up to 32 chips. Has an incorporated safety switch which automatically switches off the UV lamp when the Eraser is opened. **£37.00**

## TEXTIME

(SOLID STATE ELECTRONIC TIMER)

EPROM Erasers need just half an hour to finish their job. It is the proper erase time for all EPROMs. While the Eraser is busy you may take a break but not for too long without our TIMER on the job. Over erasing can shorten data storage time. TEXTIMER will remember to switch off the lamp and your chips will forget nothing new. TEXTIMER will pay for itself in no time.

**ONLY £15.00**

**For more Software & Hardware turn to next page.**

## EPROMS for BBC MICRO

	1+	25+
2764-250nS	£3.95	£3.50
27128-250nS	£23.00	£19.95

## EPROM PROGRAMMING SERVICE

We now offer a 'while u wait' EPROM copying service (24 hours on Mail Order). Just bring along the EPROM to be copied (we can supply any type of EPROMs at unbeatable prices) and while you wait, we shall copy, test and verify the copied EPROMS.

Copying Charge **£2.00** per chip  
(Quantity discount available)

## BBC MICRO DFS by Watford Electronics

This new DFS is fully compatible with ACORN DFS and has many more features..

The extra features include:

- Optional Double Directory (gives 62 Files per side)
- 40 Track disc can be read on 80 track drives (software switchable)
- Workfile saves typing of Filenames.
- All Format and Verify commands ROM resident, so no costly utility disc needed.
- Special Commands are included to ease transfer of Cassette programs to disc.
- Optional - Copy command available.

Price: DFS ROM only **£42**  
Complete DFS Kit **£85**

(P.S. We shall exchange your existing Acorn DFS ROM for this highly superior Watford's BeebRom for **£35**).

BBC DFS Manual - **£7.50**

## BBC GAMES SOFTWARE (BUG-BYTE)

SPACE PIRATES	£6.95
SPACE WARP	£7.80
GOLF	£4.75
DRAGON QUEST	£10.00
FRUIT MACHINE	£4.75
CITY DEFENCE	£6.75
MULTI-FILE	£8.75
BACKGAMON	£6.95

## (COMPUTER CONCEPT)

ASTEROID BELT	£7.80
CHARACTERS	£5.80
HITCH-HIKER	£5.95
SNAKE	£7.80
SPACE HAWKS	£7.80

## (MICRO POWER)

ADVENTURE	£6.95
ALIEN DESTROYER	£6.95
ASTRO NAVIGATOR	£4.95
CHESS	£6.95
COWBOY SHOOTOUT	£5.95
CAT & MOUSE	£4.95
CROACKER	£6.95
ELDORADO GOLD	£5.95
FOOTER	£5.95
GOMOKU	£4.95
GALACTIC INTRUDER	£6.95
LASER COMMAND	£6.95
MARTIANS	£5.95
MAZE INVADERS	£4.95
MUNCHYMAN	£5.95
MASTERMIND	£4.95
MOONRAIDER	£6.95
REVERSI	£4.95
STARTREK	£4.95
SWOOP	£6.95
SEEK	£5.95
TIMETREK	£6.95
ZOMBIES	£4.95
GALACTIC COMMANDER	£6.95
MICRO BUDGET	£7.95
ROULETTE	£6.95
SPACE MAZE	£6.95
KILLER GORILLA	£6.95

## Wordwise

£34

Without doubt the most sophisticated piece of software yet written for the BBC Micro. Wordwise contains all the usual word processing features enabling characters, words, sentences or any defined section of the text to be deleted, moved or copied from one part to any other part of the document. The more complex facilities such as search and replace or file handling commands are menu driven so that even a beginner can understand how to operate them. Wordwise will work with whatever filing system is currently implemented. Supplied with full fitting instructions and a spiral bound manual. We believe this word processor compares favourably with those costing many times as much.

## LOGO II £9.95

This language is very popular in American schools as it is an ideal educational program. It can graphically demonstrate the ideas of defined procedures, sub-routines, loops and even recursive programming. Gives excellent introduction to LOGO language for young and old alike.

## FORTH ROM for BBC

This superb compiling language now available in ROM. Simply plugs into one of the ROM Sockets. **£35.00**

Full FORTH Manual **£6.75**

## LOGO in ROM

This popular language now available in ROM. Manual included with the ROM.

PRICE: **£36.00**

## APPLICATION SOFTWARE

### CONSTELLATION (32K) £6.50

The great Bear! The Southern Cross! The Horned Goat! See the night sky gloriously depicted in hi-res graphics. Constellation has been adapted and enhanced from our successful ATOM program.

### DISASSEMBLER (16/32K)

The most powerful, flexible and easy to use Disassembler currently available for the BBC Micro. Has 5 modes of operation from memory dump to full automatic disassembly - ability to identify any location in memory with a label - operating system entry points and indirection vectors are already labelled when the Disassembler is loaded - ability to define a 'map' of up to 72 separate areas of machine code - output may be directed to the screen or a printer - areas of code can be disassembled and output saved on tape or disc in BASIC EXEC format for later incorporation into user programs - Machine-code programs may be loaded and disassembled regardless of their actual run-time location - the current set of labels, map and associated data may be saved at any time on tape or disc. This data can be reloaded at a later date and disassembly continued - full error checking and reporting is carried out at each step - disassembler operated by typed commands or the user definable user keys - full instructions are supplied in the form of a 'HELP' program - available on Cassette or Disc.

Cassette **£6.90**

Disc S/D **£9.90**

Disc D/D **£9.95**

### EMULATOR £7.95

An extremely powerful and flexible Cassette based machine code interpreter from Simonsoft. Treats machine as a 'high level' language and is in many ways analogue to BBC's built in BASIC Interpreter. It can therefore be used as a Monitor, Disassembler, Assembler and 'Peeko' Computer.

### Filer £8.95

A powerful file handling program for BBC FILER allows the user to build up, manipulate, store and retrieve data on the BBC. A very powerful package indeed.

## Computer Concept's Firmware

### BEEB-CALC £34.00

A ROM based spreadsheet program, like wordwise this firmware is fast and simple to use - yet is a powerful spreadsheet analysis program, considerably better than the original 'calc' program - full floating point maths. Works in 40 or 80 column screen modes - variable column widths. Works with either cassette or disc. This ROM coupled with Wordwise can turn your micro into an ideal small business machine.

### DEBUGGING PROGRAM £19.00

A machine code program. Essential for the machine code programmer. An ideal complement for the assembler built into the BBC machine. Contains a full machine code monitor allowing examination and alteration of memory, registers, setting of break points and even single stepping through machine code programs.

### DISC DOCTOR £19.00

This ROM contains useful disc utility programs. Enables recovery of any data off the disc including deleted files etc. The full disc editor allows the alteration of any bytes directly on the disc (or in memory), or the loading and saving of any track or sector on the disc. Automatic transfer of programs from tape to disc and vice versa. Also includes a whole host of other useful utilities - string search, function key editing, the ability to format 35, 40 & 80 track discs.

### PRINTER TOOL-KIT £19.00

This ROM includes routines for high resolution screen dumps for both the EPSON and NEC printers. Will work in any graphics mode with automatic grey shading of all screen colours. The most useful feature of this program is its 'spooling' capability. This enables data such as a program listing of high res screen dumps to be automatically spooled from your disc to the printer while using your BBC machine for running other programs.

### ★ SPECIAL DISCOUNT OFFER ★

We allow a special 10% discount on all the above four Firmware when purchased with our '13 ROM Socket Board'.

## BOOKS

(No VAT on Books)

30 Programs - BBC Micro	£4.95
30 Hour BASIC (BBC Micro)	£6.00
6502 Application Book	£10.25
6502 Assembly Lang. Programming	£12.50
6502 Assembly Lang. Subroutines	£11.80
6502 Software Design	£10.50
ACORN ATOM Magic Book	£5.50
Advanced 6502 Interfacing	£10.95
Assembly Lang. Programming for BBC	£8.95
BASIC Programming for BBC Micro	£5.95
BBC Micro DFS Manual	£7.50
BBC Micro Revealed	£7.95
BBC Micro Instant Machine Code including Software Cassette	£34.00
Creative Graphics on BBC Micro	£7.50
Discover FORTH - Osborne	£11.25
Easy Prog. for BBC Micro	£6.50
Further Prog. for BBC Micro	£6.90
FORTH Programming (Sams)	£12.50
Getting Acquainted/Acorn ATOM	£7.95
Graphs & Charts on BBC Micro	£7.50
Intro to Micro Beginners Book (3 Ed.)	£9.90
Let your BBC teach you to program	£6.75
Micros in the Classroom	£4.90
Practical Prog. for BBC & ATOM	£5.95
Programming the 6502	£10.75
Mastering VISICALC (Sybex)	£11.95
Structured Prog. with BBC BASIC	£9.50
The BBC Micro An Expert Guide	£7.90

## Level 9 Software

3 New Adventure games. May be the best yet written. We strongly recommend them. All have over 200 individual locations and packed with puzzles. A game can take easily months to finish. Only sophisticated compression techniques can squeeze so much in.

ADVENTURE QUEST (32K)	£8.60
COLOSSAL ADVENTURE (32K)	£8.60
DUNGEON ADVENTURE (32K)	£8.60

ONLY THE BEST AT  
WATFORD

# BBC SOFTWARE

## GEMINI'S BUSINESS SOFTWARE

Written by professional Chartered Accountants and coded by competent programmers. Ideal for small and medium sized companies. Now available from stock.

## CASHBOOK ACCOUNTS £52

One of the most innovative programs on the market. Replaces a manual cashbook system, e.g. Simplex and ALL-in One. The program is simple to use and will replace manual Cash & Bank records. Gives you access to vital management information as and when you want. It enables you to keep more positive financial control of your business.

The software is extremely well and lucidly documented. Gemini provide a full technical back-up and product up-date policy. The features include:

Summary of VAT information for VAT returns - Cumulative receipts and payments report analysed over the standard profit and loss and balance sheet headings - Options for departmental analysis of sales and purchases - Audit trail printout of all transactions - Journal routine for entering transfers between accounts and year end adjustment for debtors, creditors, etc. - Trial balance at any interval - Interfaces to Final Accounts program to produce balance sheet and trading and profit/loss account, etc.

## FINAL ACCOUNTS PROGRAM £52

Requires Cash Book module. This program will take your cash book data to the logical conclusion of balance sheet, trading and profit/loss account and notes to the accounts i.e. Fixed Assets, land and buildings and capital accounts. Final accounts links to 'Beebplot' for graphic data presentation.

## INVOICES & STATEMENTS £17.25

A complete suite of programs together with generated customer file for producing crisp and efficient business Invoices and monthly statements on your line printer. All calculations include VAT automatically and the programs allow your own messages on the forms produced. This program gives you superb presentation and saves time on one of the most tedious tasks in the office.

## COMMERCIAL ACCOUNTS £17.25

A gem of a program. Daily Journal, Credit Sales, Cash Book, Credit Purchases, Other Purchases, Sales ledger, Purchase ledger, Bank accounts, Year to date summary. A fully interactive program suitable for all businesses. Files can be saved and loaded and totals from one file carried forward to another on cassette. Particularly useful from a cash flow point of view and immediate accessibility to totals for debtors and creditors. Bank totally supported with entries for cheque numbers, credits and running balance.

## MAILING LIST £17.25

A superb dedicated database to allow for manipulation of names, addresses and other data. The unique 'Searchkey' system gives you a further ten 'user defined parameters' to make your own selections. Feature includes the facility to find a name or detail when only part of the detail is known. It will print labels in a variety of user specified formats.

## DATABASE £17.25

The program that everyone needs. The most valuable and versatile in your collection. Facilities include sort search, list print if required. Can be used in place of any card index application. Once purchased you can write your own dedicated database to suit your particular needs with a limitless number of entries on separate cassettes.

## STOCK CONTROL £17.25

Dedicated software with all that is necessary to keep control of stock. This program will take the tedium out of stock control and save time and money. Routines include stock set up, user reference number, minimum stock level, financial summary, line print records, quick stock summary, add stock, delete/change record and more.

## HOME ACCOUNTS £17.25

Runs a complete home finance package for you with every facility necessary for keeping a track of regular and other expenses, bank account,

mortgage, H.P., etc. This program also allows you to plot graphically by Histograms your monthly outgoings.

## BEEBCALC SPREADSHEET ANALYSIS £17.25

Spreadsheet processors have proved to be important tools for using micros in business, scientific and domestic financial applications. Without any programming knowledge at all, you may:-

- Set up a computerised spreadsheet, with chosen row and column names.
- Specify formulae relating any row or column to any other.
- Enter your source data and have the results calculated.
- Save the results on tape (or disc) for later reloading and manipulation.
- Print the tabulated results in an elegant report format.
- Access saved files and write own reporting or graphics presentation programs for the results.
- Ideal for anything that involves repeated re-calculation of results presented in tabular or spreadsheet format.

## BEEB PLOT £17.25

Presents numeric and string data together in easily understood pie chart, histogram or graph format. Beebplot has a built-in interface to Beebcalc and the final Accounts program of Cashbook. The facility for mathematical function plotting and screen dumps for Epson or CP-80 printers is also provided. Gives superb results either from direct input of data from the keyboard or via simple access to other software data files. A must for business and education.

N.B. All the above prices are for CASSETTE based Software. For DISC based Software please add £3.00 per Software. When ordering please specify the type of diskette required (40 track or 80 track).

### ★ SPECIAL OFFER ★

During the months of June and July 1983 we are offering the following special discounts:

**3 for the price of 2**

**5 for the price of 3**

**7 for the price of 4**

(above discount does not include Cashbook and Final accounts)

**Buy Cash Book & Final Accounts together and pay ONLY £82.75**

### Access Orders

Just phone your order through and we do the rest. Tel: (0903) 50234/40588.

### PLINTH FOR BBC MICRO

Protect your micro from the weight of the heavy TV/Monitor. This sturdy plinth is attractively finished in BBC colour. It can be used to support a monitor or a printer. The micro slides underneath comfortably. A must for every BBC Micro owner, specially for those who have to move/open their computer frequently.  
**Price: £11.95 (carr. £1.50)**

### BBC DFS MANUAL

A fully comprehensive disc manual for BBC Micros. All extra commands are included. A bargain at **£7.50 (no VAT)**.

**WATFORD ELECTRONICS  
CARDIFF ROAD, WATFORD.  
Tel: (0923) 40588. Telex: 8956095**

MAIL ORDER AND RETAIL SHOP. TRADE AND EXPORT INQUIRIES WELCOME. GOVERNMENT AND EDUCATIONAL ESTABLISHMENTS OFFICIAL ORDERS ACCEPTED. CARRIAGE: Unless stated otherwise, please add 60p to all cash orders. VAT: UK customers please add 15% VAT to the total cost incl. Car. SHOP HOURS: 9.00am to 6.00pm. Monday to Saturday. ACCESS ORDERS: Simply phone: Watford (0923) 50234.

## EDUCATION Software

**JUNIOR MATHS PACK (32K) £6.95**  
Makes learning fun for 5-11 year olds. This package consists of 3 programs (menu driven) that increase in difficulty as your child becomes competent. A very good supplement to standard educational methods.

**WHERE? £6.95**  
Do you know WHERE? you are? This well written program, using high resolution graphics offers timed tests on the geography of Great Britain.

**WORLD GEOGRAPHY (32K) £7.00**  
Beautifully drawn Hi-Res colour map of the world illustrates and aids this graded series of tests on capital cities and populations of the world.

**WORDHANG £7.80**  
(Age 7-13). A word guessing program based on the well known Hangman game. Uses full colour graphics. Complete with 260 words and the facility save your own list of words.  
**WORLDWIDE £7.80**

(Age 7-15. Two constructive geography programs allowing children to build detailed data bases covering both the UK and the world. Encourages children to refer to atlas and reference books. Save the database anytime.

**ANIMAL/VEGETABLE/MINERAL £4.95**  
(Age 7-13). Provides an opportunity for children to teach the computer to differentiate between objects. The program tries to guess the object the child has thought of, using personalised responses like Mmm... I am thinking.

**BRITISH GEOGRAPHY £6.95**  
Teaches a child the locations of Cities and Ports using directional keys.

**CAROUSEL £5.50**  
Aimed at junior school age. Sequences of colours and sounds teaches a child to concentrate.

**HAPPY NUMBERS £7.80**  
(Age 4-6). No reading skills are required to use this colour graphics number recognition and counting program. Children build patterns of flowers corresponding to figures, quickly learning their significance.

**INTRO TO ARITHMETIC £10.45**  
4 programs - Additions, subtractions, multiplications and divisions. Help stage, moving graphics and colours. Worksheet produced at the end of program. (5-7 years old).

**WRITING £5.50**  
Full screen demonstration of correct formation of lower case alphabetic characters. Several choice of sequence (5-7 years).

## BEEB SPEECH SYNTHESISER

### VERSATILE SPEECH SYNTHESISER UNIT FOR THE BBC MICROCOMPUTER

Watford Electronic's very own Speech System. Specially designed so that even a novice can make his BBC talk:-

**SIMPLY the best!** - An unlimited speech synthesis system. Complete with easy-to-follow manual. Controlling software is in ROM so no Cassette Loading problems!

**PHONEMES** for word synthesis - That means unlimited vocabulary! No extra speech dictionary chips to buy!

**ENGLISH accent** - Utilises inflexion techniques to produce highly comprehensible speech.

**EASY to use system** - Just plug the software ROM into a socket, the Speech unit into the User Port, and away you go! No specialised 'dealer upgrade' required!

**COMPACT unit** - The whole system is built into a small case - easily tucked behind the computer.

**HOURS of fun!** - Suitable for any application - Games, Educational Programs, Specialised Packages.

We know this all seems too good to be true but **DON'T BE LEFT SPEECHLESS!** Order your Versatile Speech Unit now!

**DRAGON/32 BBC MODEL/B TRS 80 C/C 32K**  
**747 FLIGHT SIMULATOR**

Superbly realistic instrumentation and pilot's view in lifelike simulation which includes emergencies such as engine fires and systems failures. This program uses high resolution graphics to the full to produce the most realistic flight-deck display yet seen on a home computer. There are 21 real dials and 25 other indicators (see diagram). Your controls operate throttle, ailerons, elevators, flaps, slats, spoilers, landing gear, reverse thrust, brakes, etc. You see the runway in true perspective. Uses joysticks and includes options to start with take-off or random landing approach. "A real simulation, not just another game." (Your Computer Apr. 83).

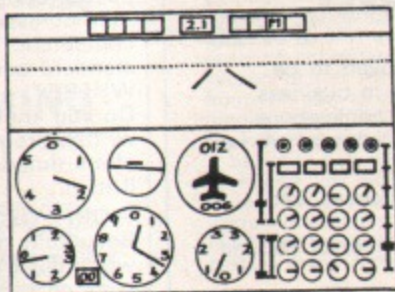

CASSETTE £9.95 (pp and VAT included)

**NEW · NEW · NEW · NEW**  
**BBC MODEL/B ARCADE ACTION GAMES**

**D.A.C.C. proudly announce the following all-new fast-action arcade style games:-**

**THE GUNS OF NAVARONE**

This one is truly addictive. Defending your cliff-top stronghold from attack by helicopters and enemy naval shellfire is no pushover. There are three starting levels and the game also responds to your skills with increasing ferocity of attack. Use your rapid-fire anti-aircraft gun to bring down the choppers, at the same time, set your shell strength and trajectory to blast the advancing destroyer. If a ship gets through your defences to detonate your arsenal of ammunition then you and your guns will suffer devastating explosions. Great colour, animation and sound make this one a real winner.

CASSETTE £7.95 (pp and VAT included)

**MERCY MISSION TO MARS**

A space battle with a difference. Stretch your firing skills to the limit defending your ship from fast moving "plasmoid" destroyers. If you survive you then have to land your descent module on the Martian surface and pick up personnel pods, take-off again, dodging marauding asteroids and locate the "transporter beam" to ensure safe return of your charges. Ten skill levels in this fever-pitch all action game.

CASSETTE £5.95 (pp and VAT included).

Despatch within 48 hours.

**D.A.C.C. LTD., Dept BMU,**  
**23 Waverley Road, Hindley, Gtr. Manchester WN2 3BN.**  
 (15 years professional computer experience)

**ON SATURDAY**  
**1.00 pm - 5.00 pm**

**SPECIAL DEMONSTRATION OF BBC MICRO**

See for yourself the latest business programmes and a wide selection of games

**plus**  
**Micronet**

For up to the minute information from Prestel via your BBC micro.

At  
**CCE Europe Ltd**  
**Creswicke House,**  
**11 Small St,**  
**Bristol.**  
**Telephone 215226**

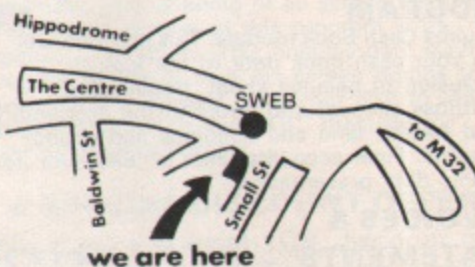

we are here

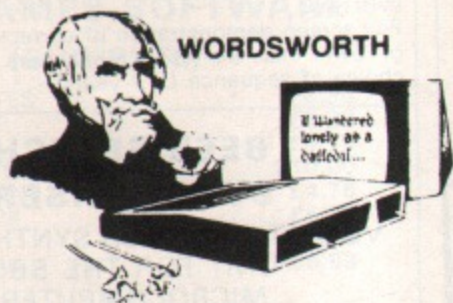

**WORDSWORTH**

BEFORE YOU BUY

**A BBC WORD-PROCESSOR**

ASK YOUR DEALER THESE QUESTIONS:

- \* Will it print a 100K document at one command?
- \* Will it personalise a standard letter to 999 club members at one command?
- \* While it is doing that, can I type up the minutes of the last meeting and save them on tape?
- \* Can I see all the time how my print-out will look, using an ordinary television set?
- \* Can it use the upside-down italics feature of my Obscuro Printer (without my having to buy an extra tape for £10)?
- \* Can I embed printer codes at any position within a text line?
- \* Will it align my 8-decimal-place figures, and add them up automatically for me?
- \* Can I lock the keyboard in case the cat goes to sleep on it?
- \* Can I search and replace, centralise text, count words, etc?
- \* Does it work with all BBC operating systems, using cassettes?

IF ALL THE ANSWERS ARE YES,  
 AND IT COSTS LESS THAN £20,  
 BUY IT.

**IT MUST BE WORDSWORTH!**

ALSO AVAILABLE DIRECT, PRICE £17.25, FROM

**IAN COPESTAKE (W3)**

23 Connaught Crescent, Brookwood, WOKING, Surrey, GU24 0AN  
 Telephone 048 67 Brookwood 4755

Printing service available. Disc versions supplied to special order.

**MICROWAVE**

**Educational Utility Software for the BBC Microcomputer**

**■ GRAPHICS AID PACK**

Two menu driven programs, an A4 reusable draughting grid, booklet and pens.

Program 1 - **TELETEXT PLANNER**: Makes full use of Mode 7 text and graphics. Draw, save or load a screen, view a test screen. Text and graphics are entered directly from the keyboard and all control codes are via the function keys. Screens can be preplanned using the wipe-clean draughting board.

Program 2 - **CHARACTER GENERATOR**: Design and save your own characters. Observe, invert and reverse ASCII code patterns. Greek and Russian character sets are supplied in \*EXEC format.

Graphics Aid Pack ..... £8.95

**■ INDEX**

A fully documented, menu driven program for authors (and readers of unindexed books!). This utility allows the creation of an index with automatic alphabetic sorting. Options include; creating a new index, reading and amending the index file, printing and saving the final index. Data is protected from loss, e.g., pressing the break or escape keys. (Printer interface required for 32K Model A)

Index ..... £6.95

**■ DYNAMIC NUCLEAR MAGNETIC RESONANCE SPECTROSCOPY**

This useful program plots a high resolution (Mode 0) nmr line shape for a two site exchange with and without coupling. It gives a superb demonstration of the effect of the coupling constant on an AB spectrum. Hard copy of the spectrum onto EPSON printers is available as an option within the program. A 40 page manual is supplied, "Introduction to DNMR spectroscopy". (Manual available separately (£3.95).

DNMR ..... £8.95

**■ LISTING SERVICE**

Want a listing of your valuable program? We offer a very competitive service, e.g., for an &10 block from £0.95p.

40 track disc versions available - Add £3.00 to above price. Send SAE for descriptive leaflets on any program above.  
 All programs for Model B or 32K Model A, OS 0.1, 1.0 and 1.2

DEALER ENQUIRIES WELCOME

24 Belford Road, Stretford, Manchester M32 0DL.



THE last meaningful relationship I had with a computer was many years ago via rooms full of equipment like sorters, punch-cards etc. You can imagine my surprise at Christmas when a friend brought his Apple to stay for a few days.

I got hooked, read everything I could find on micros, and picked everybody's brains. At first I was going to get a ZX81, but of course I actually bought a BBC Model B last February.

I find however that as a complete novice, I am getting bogged down with bugs and printing errors.

The BBC manual is not exactly instructional in basic Basic. Your beginners articles on programming are good but I am getting impatient. I cannot wait four weeks between each bit. Can you therefore recommend a good book? There are so many which look okay, it's hard to choose.

Considering how logical and accurate micros are, I am very surprised at the state of the printing in a lot of the books containing program listings. This apart from the printing errors, silly games (like draughts where the computer doesn't "take") and lack of instructions on how to actually play the games.

I was therefore very pleased to get your Deathwatch to work (am I supposed to have debris from blasted tanks littering my hillside?) and King Kong is nearly there.

Trouble is I keep getting "no room" when the scoreboard comes up. Any suggestions?

I have just started on Air-strike. What a shame you didn't print the table of variables and program structure this month, it was very helpful for de-bugging.

Thank you for being "reader friendly". — Carol Lambert, Stapleford Abbots, Essex.

● Recommending a good book on the BBC Micro is rather like going out with a friend's sister — fraught with all sorts of complications! Having said that, we've always been

## Getting down to basic Basic instruction

adventurous in that respect (recommending books, that is) so here goes: "Easy Programming for the BBC Micro" by Eric Deeson is the one you want.

The thing with programs like Kong and Airstrike is that they take up a fiendish amount of room. Anything extra you add, perhaps inadvertently when using COPY, can cause problems. Our rather brutal recommendation is to leave out the instructions from the title page. This should give you plenty of room.

Yes, you are supposed to have debris, author Brian Clark swears...

### Moving over to disc

EARLY this year I bought a model B BBC Micro and just recently I have invested in a single disc drive.

I now find that one of the jobs I intended to do is not as straightforward as I had hoped, namely transferring cassette-based programs which I had purchased on to a disc!

I have been a user of Commodore equipment for many years and when I progressed with this system to disc drives the transfer was easy, as no memory shift took place. I now find with the Beeb that cassettes locate at &E00 but discs at &1900.

I have a number of games programs and some I have managed to transfer (Chess, Swoop; Arcadians) but games from Acornsoft, for example Snapper and Monsters, have completely eluded me. I would have thought that the Acorn

people who produce the computer would have allowed for compatability.

I am writing to you as I find your magazine for the BBC very helpful and interesting and as you specialise in the BBC machine I thought that you would be able to offer some help.

If you could assist in any way I (and my children who are used to the fast Pet disc facilities) would be very grateful. — D.J. Fudge, Leicester.

● Copying cassettes onto discs has caused our readers quite a few problems. I'm glad to say that we have got an article by Peter Walker on this subject in this issue. See Page 30.

If Peter's methods seem like too much hard work, Clares, who advertise in this issue, have a very clever program called Replica that does the job for you. I suggest you get in touch with them.

### Plea for the robots

I THINK your magazine is the best on the market. I especially like the Beeb Body Building Course.

I undertook the BBC upgrade immediately and now have a fully operational model B. (I couldn't have done it without you!)

I am particularly interested in robotics, and when I heard about the BBC Buggy I was over the moon, though the price brought me down to earth.

I wonder if you would publish any articles about robots and interfacing things to the BBC? I have just mastered the user port

and am now advancing towards the 1MHz bus.

I have one more question. Where can I get a pair of powerful (robot-style) stepper motors? I've tried everywhere. — R. Champney, London.

● It is good to know we have been of some help. We hope to cover a little of robotics later on in the magazine, but if you want to jump the gun you can get stepping motors from Chiltmeade. A stamped addressed envelope will bring you their list.

### More on \*LINE

HERE are some more details of the OS commands \*LINE and \*CODE. They can be described as follows:

\*CODE x,y (x and y are decimal integers in the range 0 to 255).

The specified values x and y are loaded into the X and Y registers respectively, and the accumulator is loaded with zero.

An indirect jump is then performed to the address specified by USERV (located at &200) — the users routine should be located at this address, for example \*CODE 23,250.

\*LINE s (s is a string of characters). The X and Y registers are loaded with the lo and hi bytes respectively of the address of the first character of s, and the accumulator is loaded with '1'.

Note that leading spaces are stripped off, for example \*LINE

# MICROMAIL

## From Page 105

Hook Line Sinker – NO quotation marks.

To summarise, \*LINE and \*CODE call a user supplied routine whose address has previously been deposited in USERV.

\*CODE allows the user to specify the contents of the X and Y registers on entry. \*LINE allows the routine to access a string of data.

When a reset occurs USERV is set to point at &E310 which is the location of the "Bad Command" message, which is why the commands invoke this error until USERV is set up.

The fact that \*CODE and \*LINE load the accumulator with 0 and 1 respectively is very important. It means that the user can write a routine to deal with both commands simply by testing the contents of the accumulator. If it contains zero then branch to the \*CODE handling routine, otherwise continue with the \*LINE handling routine. – Colin Browell, Sunderland.

## Advanced 3D games

I SAW a Saturday morning BBC TV programme which demonstrated the latest generation of TV games and their very advanced 3-D graphical representation of arcade games.

I would be interested to know what special hardware features these products have which permit them to do this.

Is it more memory, faster processors or the use of special languages? Will it be possible for future add-ons to the BBC Micro to allow similar 3-D games to be written? – R.S. Tunbridge, Sittingbourne, Kent.

● This system allowed a computer to access various tracks on a video disc, which could then show several sequences depending upon the user's input.

It is unlikely that this form of add-on would be available for the BBC Micro as a lot of work goes into creating the images on the video disc. It involves normal cartoon artists drawing

the artwork in a similar way as the Walt Disney cartoons were drawn in the early '30s. This is a very labour intensive process and is a sort of step backwards in computer art.

The images are not actually created by the computer, the computer just controls the order in which you see the images.

In the foreseeable future that isn't really on in a home machine, but who knows what the next 10 years will bring?

## No IC explosion

WITH reference to the Beeb Body Building Course in the May Micro User, no doubt I am the "Nth" person who has written to you on a rather destructive error in Figure 1 on page 38.

The analogue IC will not accept any greater voltage than 1.8v (IC73). The joystick circuit shows the "hot" end of the potentiometer taken to pin 1 (+5v), and should the slider

travel anywhere near to this voltage either during adjustment or use the IC will surely blow.

I am sure that this is a type-setter's error and that I do not need to go to great lengths on the subject, but I note your Mr Cook takes the "fire button" to analogue earth. This was not the way Acorn had in mind – it can lead to intermittent operation due to hum loops in the earth return path.

The "fire" buttons should only be across pins 6 and 13 (CH0) or 3 and 10 (CH1). – Peter Clappison, Hull.

● I think you have misunderstood what was meant in my article, writes Mike Cook. There is in fact no typographical error in the diagram and the "hot" end of the potentiometer should go to +5v.

In my article I explained the reason for this is to increase the range over which the potentiometer will work. This is because in the joystick arrangement the mechanical movement is somewhat restricted and this arrangement affords a little amplification, albeit mechanical.

As to your concern about blowing the IC, do not be worried in the slightest. True that the IC will not accept any greater voltage than 1.8 but that is only for conversion, and any voltage greater than this will just show as the maximum possible value.

In fact according to the specification sheet for this device, which is a PD72002C, the input may be taken to a voltage 0.3 of a volt greater than the supply voltage on the chip without suffering any damage.

As the supply voltage on this chip is 5v, you can see there is no danger in taking this voltage up to 5v. In actual fact, the entire chip may be operated up to 7v without suffering any permanent damage.

As to the second part, it is true that the fire button is taken to the analogue earth but there is no difference between the analogue earth and the supply earth.

I think Acorn had it in mind when they designed the board

## Interpreting the disassembler

AS I wished to learn something about assembler language, I bought your April Micro User tape. The only item on it that interested me was the Disassembler.

As Jim Notman gave the program for this, I thought it would help me to see how things worked if I instructed the computer to interpret the beginning of the Disassembler's own program.

The result made it fairly obvious that the interpretation was not correct.

As Mr Notman indicates in his article, the entries from E06 on are spelling out the name "Jim Notman", so in E06,4A is the Ascii number for J. However the tape interprets this as LSR A, which surely it has nothing to do with.

In line E0C the tape can make nothing of &74, which I take to be the "t" in Notman. Further down, E19 to E1D seem to be spelling out the date 1982 (not 1983 as in the

magazine article), and again I imagine this has nothing to do with jumping to a subroutine, as the line with E19 suggests.

Your magazine claims to deal with the beginning of topics. It would be very helpful if an article such as Jim Notman's contained some sort of running commentary on the language used.

For instance, I notice &DOA, and later &D014,&D01E, with &A, &14,&1E meaning the decimal 10,20,30. Are these labels for the line numbers? If so, how do they tie in with instructions to OR the accumulator?

I would welcome some reassurance as to the validity of Disassembler in regard to the later parts of its own program, as I find a good way to learn a language (computer or otherwise) is to see how it deals with a known passage. – W.W. Sawyer, Cambridge.

● Jim Notman's very useful program contained both a dis-

assembler and a hexadecimal dump, and you appear to have confused the two functions.

Both are to allow the user to look at RAM. The disassembler is to allow the user to investigate RAM that contains machine code routines. The hex dump is for decoding chunks of memory other than machine code, especially Ascii encoded bytes, such as the basic keyword tables and parts of programs.

Such memory is not meant to be interpreted as machine code, and to use the disassembler on them will, as you point out, produce garbage.

I think you'll find that our magazine does not claim to deal solely with the beginning of topics. There are a great number of capable programmers who have realised the excellence of the BBC Micro, and it is our policy to cater for them also.

Disassemblers and the like are not for beginners.

that the A to D converter was much more sensitive than it actually is, and no extra hum will be introduced by doing this that is discernible by the A to D converter, if in fact there is any extra hum at all.

This will not lead to intermittent operation – I have tried this over many months myself and have had no difficulties at all.

## Getting into LDA

*I'VE just read your March and April issues and was very impressed. Your magazine seems ideal for people like me who know nothing. The only comment I would make is that in your April issue Part Two of "How it works" you assume a vague knowledge of what LDA, STA, JSR etc. means. I don't know!*

*I can convert quite happily from denary to binary-hex, surely it would not have increased the length of the article too much? – David W. Sills, Tabuk, Saudi Arabia.*

● I take your point, Mr Sills, but I'm afraid in this case it would have taken far more than just a few words to explain even vaguely what terms such as LDA, STA mean. Fear not though, we shall soon be starting our definitive series on machine code for the beginner.

## Finding the function

*A TIP – if you have programmed the function keys, and forgotten exactly what you put in them, type a line number higher than the highest line of your program, and press the function key – this will then appear on the screen, but not be actioned.*

*If the key definition contains more than one //M, instead of just the line number, type AUTO (line number) before pressing the function key. – A.E. Wilmshurst, Crowborough, East Sussex.*

## Spreading the light pen

*TWO cheers for the Micro User! (Well, say 2½.) Most of the contents are well worth reading. I find that you tend to assume that most of the BBC owners are new to computers.*

*Is this borne out by the facts? Surely most people who spend £300-£400 on a computer have some previous knowledge?*

*How about a light pen article in the Body Building Course?*

*Please do NOT list programs in Jim Notman's format. Is this just a way of filling more pages? – I.R.L. Morom, Redditch.*

● The people who've bought BBC Micros seem to fall into two camps – those who know very little about computers and bought a BBC Micro because they were shrewd enough to spot a bargain when they saw it, or just took the magic letters "BBC" as a seal of approval.

And those who know an awful lot about computers and who know an excellent bargain when they see one. We have to cater for both! Spending £300-£400 is not immediate proof of computer knowledge.

The light pen article is

coming up, though we cannot say when. Every time we see Mike Cook he's produced some new piece of electronic wizardry. At the moment he's working on a device to enable him to avoid editors...

As for Jim Notman's way of listing, it's a desperate attempt to try to staunch the number of calls for help that flood in from people who find listings very hard to type in.

We hope the new format will make things clearer for them. It's definitely not a ploy for filling more pages.



## Missing PROCSTAR

*I TYPED in the Space Pilot program in the June Micro User. I found it addictive and I was able to achieve high scores.*

*But after reaching around 10,000 and receiving PROC-NEWS I discovered that a procedure was missing :PROCSTAR. It says this in line 340, but has nowhere to go. I got an error message and lost my score.*

*Where is PROCSTAR? – Kevin Robertson, Luton.*

● True, there isn't a PROCSTAR. What happened was that we asked the programmer to take it out of the program for various reasons. He got rid of all the references bar one, which you found. As you point out, it doesn't appear until you get a rather high score, and none of us here are that good.

All you have to do is to omit :PROCSTAR from line 340 and all will be well.

## Colour clue

*CAN you please help me? I have a BBC B Micro and I wish to have colour on the composite video output.*

*I have heard that the conversion is not difficult. The reason I need this is to put titles on video. I enclose a stamped addressed envelope for your reply, but perhaps the rest of your readers would also be interested in this upgrade. – C.B. Geiser, Goodmayes, Essex.*

● You will have noticed that plugging the video output into a colour monitor does not result in a colour picture. This is because the colour burst signal has been omitted from this output. Goodness knows why, because it is quite simple to put back.

All you need to do is to connect a 56 picofarad capacitor between R123 and Q9. You should carefully solder one end of the capacitor to the resistor and put a piece of insulation sleeving over the other and take it to the emitter of the transistor. This will then put the appropriate burst signal into the video.

The video output will then be a fully composite PAL encoded output and it will then be possible to connect it to a colour monitor. However we

hear that Acorn do not authorise this, so if you are in any doubt at all, please take it to your dealer who might be kind enough to do this modification for you – at a price.

## Unsnipped links 1

*I HAVE a model A machine which I have upgraded to B specification following your Body Building Course. I have inserted chip 74LS163 (IC76) but have not as yet snipped links S12 and S13 as your article in the March edition implied that this was not necessary until further ROM expansion was required.*

*I was somewhat disturbed when a colleague, who has done a similar expansion, pointed out that in a similar article in another magazine, it stated that these links must be cut before the machine is used again.*

*Is this correct? If so, what damage am I likely to have done to my machine? So far (one month later) no detrimental effects have shown themselves.*

*May I add my name to the growing list of those singing the*

# MICROMAIL

## From Page 106

praises of your magazine. I like your style - keep it up. - D. Simpson, Sherburn-in-Elmet, Yorks.

● Do not worry about not having snipped links S12 and S13 as this will not damage the machine.

Contrary to what has been said in other magazines, the only thing that could possibly go wrong is that IC76, that is the 74LS163, could possibly have been damaged.

However, this is very unlikely as these devices are made to withstand a permanent short circuit to earth on their outputs so that there is little danger of them becoming damaged.

Some people are a little paranoid about shorting outputs.

## Unsnipped links 2

I HAVE bought the Wordwise chip and 1.2 ROM supplied by Computer Concepts. My computer is the BBC Model B.

The 1.2 chip has been inserted correctly and responds to the \*FX0 command with the screen message OS 1.20.

When the Basic ROM is transferred to one of the sockets C, D or E it does not work. The screen display when switched on is "Language?". Return the Basic ROM to socket B and the computer works again.

Inserting Wordwise in socket B operates Wordwise but does not transfer to the Basic ROM when requested. Wordwise does not operate in sockets C, D or E.

IC76 was supplied with the machine. Links S18 and S33 are correct and have been checked several times. My dealer is unable to solve the problem. - ??, Thurso, Caithness.

● Thank you for your letter. Unfortunately I am unable to translate your signature so for the moment you remain an anonymous Micro User!

We think your problem is that links S12 and S13 have not

been cut. These are by the plug that connects the keyboard to the main computer board.

Just snip them open with a pair of tin snips and this will enable the sideways ROM sockets to work. You can then have Wordwise or any other language in the machine.

## Hong Kong phooey

ISSUE Number 4 of *The Micro User* implied that all BBC Micros are manufactured in Hong Kong.

In fact, all machines sold in the UK have been manufactured in the UK and machines manufactured in Hong Kong will NOT be sold in the UK.

Would you please be kind enough to correct any misunderstanding which could well have occurred, at the earliest opportunity.

At the same time, you may care to correct the misprint on Page 4 since it was the hundred thousandth machine which was presented to Charing Cross Hospital. - Colin Malone, BBC Enterprises.

● We have never stated that all BBC Micros are made in Hong Kong. The first issue of *Micro User* very clearly pointed out that machines sold in the UK and the rest of Europe were built in Britain, and that the Hong Kong production line was primarily to supply BBC Micros to Far Eastern and Australasian markets.

## Services rendered

THANK you for a smashing publication. Thank you for those value-for-money tapes. Thank you for your good service. (I ought to set this to music!)

I relax, after spending hours typing in a program and then find a comma, bracket, a space where there should or should not be one, etc . . . even find a B when it should have been 8.

I then run one of your tape

games in and amuse myself.

So satisfied am I with your tapes, I have joined your 12 month tape offer. Keep up the good work.

By the way, I wonder if you could put a cracker under the tail of Acornsoft, who would do very well to take an example of service from you.

They do not seem to have much interest in the small customer except to get hold of our money.

I placed an order for three tapes mid February, I received two in fair time, but had to return one faulty, still waiting for a replacement, and for one of the original order.

It would not be so bad, but you can see the same or similar for sale elsewhere. BBC Micro User has no difficulty in delivering new programs each month.

Acornsoft, who have been spending a fortune on advertising their tapes for months, months and months cannot deliver in a reasonable time, and with the facilities available to them. They should wake up or let someone else take over. - J. Porter, Denaby Main, Doncaster.

## Still going wrong

AFTER all the problems of delivery of the BBC Micro, and the cassette bugs (which Acorn refused to take proper responsibility for) and the chaos regarding price/availability of new ROMs, things are still going wrong.

Acorn have been extremely difficult to get hold of on the phone, and they don't seem to reply to letters.

And now we have new versions of chips, which may not run your old programs.

Of course clearing up bugs can bring improvements, but not if they introduce others in their place, as has happened in relation to VDU1, so that the Acorn

technical person I spoke to said it was probably not possible to write a common print-on-printer-only routine to work on 0.1, 1.0 and 1.2 OSs.

The Basic II chip is not upward compatible from the old Basic. (@%=10:PRINT STR\$(67.8) gives different results which may upset formatting. The fact that this may be overcome by doing it a different way is irrelevant, since programs written in the old Basic didn't know they would need to do that.)

Yet, rather than warn people of this, they quietly introduce it into new machines, while denying it existed (BBC Micro User, March, Page 9) and later claiming it "wasn't different, but was transparent" (BBC Micro User April, Page 9).

Changes to existing facilities affect the credibility of not only software, but also of hardware attachments, which may have been manufactured without knowledge of what would be changed in the future.

As an example, the Amber 2400 printer will not work properly using the serial interface on the 1.2 OS.

And now - although they cannot offer adequate support to the home market - they are about to launch the micro on the unsuspecting European and American markets, trading on the good name of the BBC.

The BBC does not seem to want to have anything to do with the way things have turned out, though I would have thought they had something to lose in the USA if the reputation of the BBC is tarnished. - Kenneth Morey, London.

## Snags on supply

WHEN is Acorn going to stop mucking us about?

I paid out £399 to buy a much advertised product, the BBC Micro. After a fairly long

● Want to write to Micromail? The address is: Micromail, The Micro User, Europa House, 68 Chester Road, Hazel Grove, Stockport SK7 5NY.

wait the machine arrived.

Soon the euphoria of a new "toy" wore off and the frustrations of the operating system bugs set in.

The tape unit would not record reliably because of the fault in the OS ROM. I deliberately do not call it euphemistically a "bug" – it is a fault.

As you become more familiar with the handbook it becomes obvious that not only will the cassette system not work reliably but it is impossible to access the ROM sockets under the keyboard from the existing 0.1 OS.

And I fail to see how the ROM socket next to the keyboard can be used for "games ROMs" as advertised. As it is connected it can only be used for ROMs accessed by the speech synthesiser.

I have tried by various means to obtain a new OS, no way! I am always told they are not available yet, but if I buy any Acorn add-on that needs the

new ROM they are supplied with it.

Who is Acorn kidding? It appears to me to be a deliberate ploy by them to ensure that only Acorn add-ons will sell and eventually all the others will fall by the wayside.

This will impede the advancement of what must surely be the best micro on the market at the moment.

Come on Acorn, let's have some answers. Get the marketing up to the same standards as the machine. – R.I. Elliott, Bristol.

● I am surprised that you haven't been able to get an 1.2 OS for your upgrade – they seem to be readily available.

Nor, knowing Acorn as I do, can I accept that it's a "deliberate ploy" to push their own products. If there is a shortage of the necessary ROMs, it's probably only temporary.

Hopefully you'll be fixed up soon.

## Memory shortage

THANK you for the two corrected lines for the King Kong program, given in the May issue of *The Micro User*.

However I also had to alter line 420 to include Y%, this move X%, Y% – 15: Draw X% – 180, Y% – 15: etc. to get the firing correct on the right side of the screen.

With the King Kong and the Deathwatch programs I find that using the listings given and loading from tape I can only run the program once, enter one name and then I get "No Room" (I have a 32k 0.1 EPROM).

Are other people getting this problem, or do I have an error in the computer?

I have modified the instructions to King Kong, taking out approximately one paragraph, and they are still clear enough

to operate the program and this now enables it to run through.

With Death Watch I have removed the REM statements and taken out some spaces, and can now get nine names before the "No Room" sign.

Your comments on this would be appreciated.

In programs such as "Van Gogh", "Graphics", etc. where problems are set, do you think guides (not in full) could be given to the solutions in the next issue? J.E. Pearson, Coventry.

● Thanks so much for your letter. You are quite right about line 420 – one we missed!

Deathwatch and King Kong both use a great deal of memory. If you "tidied it up" or added extra spaces, so easily done with the copy key, you'll run into memory problems.

So far we haven't had any demands for solutions to our little tests, so we haven't published any. Of course we'd reconsider if we had more requests for them.

And finally, with tongue firmly in cheek . . .

## Missive from a faint-hearted micro user

Dear Trev,

Forgive me, for I have sinned. I didn't know I was sinning at the time, but that's no excuse. I have fallen from the path of virtue and I freely admit it.

I only found out the error of my ways when Clive, who's one of the regulars at my local (The Ram and Buffer), mentioned that he had a BBC Micro. I would have kept quiet about mine but, of course, Andrea had to open her mouth.

"Oh Bob's got one of those in the spare bedroom. He goes up and leers over it for hours every night."

So my secret was out. Myself, I'd decided not to admit to having a Beeb until I'd worked my way through the User Guide. Incidentally you were right, ENVELOPE did give me a lot of problems, but now I think I've got it licked. (Sorry!)

To cut a long story short, after a few more drinks I ended

up inviting Clive round to my place the next evening to have a look at my "software".

Andrea was particularly obnoxious all the next day. She kept on about how nice it was that I had a "little friend" and that I'd started to share my "toys". Even before he arrived she'd spoilt Clive's visit for me, but he made it even worse.

To impress him I showed him my masterpiece, a program that keeps a record of the household accounts, and when we go into the red prints a reasonably accurate picture of my bank manager with the message "Cut down on expenses, get rid of Andrea."

Clive said "Interesting", typed in LIST and all my sins were exposed.

"Good grief", he yelled, "you've used a GOTO, you've actually used a GOTO."

I was as horrified as he was but for different reasons. What

had I done wrong? What was so bad about GOTO and if it was so awful why was it in the User Guide?

Meanwhile Clive carried on with his demolition of the program (and my pride).

"Not a GOSUB. I don't believe it. Why not use a procedure? You've got a BBC Micro, not a Plectrum. Use it, don't abuse it."

He proceeded to give me a lecture on good programming (which made me feel like I'd been caught doing unspeakable things in the potting shed).

I didn't understand it all but apparently just because it's in the books doesn't mean you can use it in public. Which reminds me of something else, but I can't think what.

He pointed out that my BBC Micro had upper case and lower case characters and why didn't I use them? I told him that A. was too middle class to allow

me to use the lower case, but he wasn't amused.

"Structure, that's what you need, structure". Somehow he made it sound like lack of moral fibre.

He left shaking his head and reminding me that programs had to be intelligible to other people. "User friendly" was the term he used, which was a bit much as he wasn't very friendly to this user!

Anyway, his programs may be lucidity incarnate to others but mine won't because no one's ever going to see a listing of mine again.

Yours in adversity,

Bob

P.S. Rumour has it that Clive has recently been before his local user group's disciplinary committee for not declaring his variables in a listing. Apparently he has been ordered to use a Plectrum for a month, suspended for a year.

# northern computers

micro computer systems for all applications

## education and training division

### location

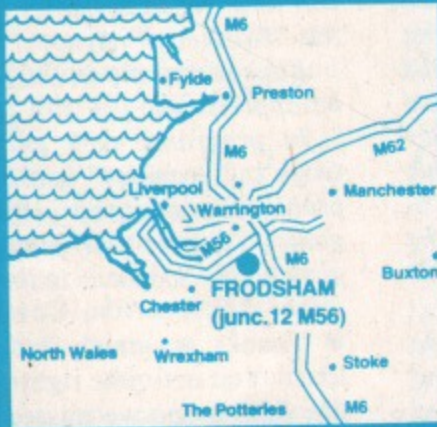

For Educational and Training Institutions only:

Apple II, III  
BBC (Free Econet Interface).  
Newbrain  
Green Monitors £79  
Colour Monitors £199  
Seiksha Printers £207  
Epson Printers £349  
COMING SOON:  
Acorn Electron

we supply everything to meet the requirements of secondary schools, colleges and universities, whether it be small B.B.C. computers, Apple IIe computers, or Apple III school administration and accounting systems.

please contact: Gareth Littler or David Horsfall  
EDUCATION & TRAINING DIVISION

Northern Computers, Churchfield Road,  
FRODSHAM, CHESHIRE WA6 6RD Tel: (0928) 35110

## ADVERTISERS INDEX

3D Computers	64	Key Computer Centre	25
4MAT Educational	92	Kingsley	65
		Kosmos	86
A & F Software	2		
ACOM	8	L.S.A. Systems	92
AMS	38	Lampas	94
Andrew Whyte & Son	75	Level 9	92
Anthony Ashpitel	75		
ASD	78	M.P. Software	62
		Merlin Computer	52
B S Dollamore	110	Micro Management	76, 77
Beeprint	65	Micro Spares	74
Bitabyte	95	Micro-Aid	84
Bourne Educational	83	Microadvent	34
		Micromode	86
C-Tech	99	Micropower	112
CCE Europe	104	Microware	104
Chalksoft	62	Midwich	37
Challenge Games	75	Multiplex Computer Services	95
Clares	23	Musicsoft	34
Computer City	111		
Computer Concepts	18	Norsoft	84
Computerama	21	Northern Computers	110
Contex Computing	95		
Cumana	24	Opus Supplies	61
D.A. Computers	90	P.J. Microsystems	95
D.A.C.C.	104	Pace	28, 44
D.R.G.	53	Psion	7
Datatech	100		
Dialog	67	Qualitysoft	94
Digital Fantasia	50		
Doctor Soft	65	R. Upfield	84
		Ricksoft	52
E.C.L. Software	84		
Educore	99	S.P. Electronics	62
Elektronequip	20	Sapphire Software	84
Eltec Computers	47	Silent Computers	34
		Silicon Centre	74
Fairhurst Instruments	86	Simon Hessell	91
		Simonsoft	92
Gaelsett	62	Skyleader	86
Gemini Marketing	32, 33	Solar Soft	83
Glengary Soft	84	Star Soft	74
Golem	65	Stacom	74
Guildford Computer	64	Superior Software	3
H.C.C.S.	94	Technomatic	29
Home & Business	49	Twillstar	15
Hudsoft	34		
		Viglen	6
Ian Copestake	00	Virgin Games	69
Ikon Computer Products	78	Voltmace	92
J & H Software	90	Watford Electronics	100, 101, 102, 103
K.J.G. Products	62	Wilmslow Micro Centre	96, 97

# AT LAST, A COMPLEX GRAPHICS SYSTEM, THAT'S SO EASY TO OPERATE

## ...IT'S PROFESSIONAL CAPABILITIES COULD BE UNDER ESTIMATED

### P.L. DIGITISER SYSTEM™

The PL Digitiser System enables you to reproduce complex pictures and diagrams, or produce original designs, quickly, easily and accurately.

The Package consists of the 'Graphics Digitiser' incorporating a tracing pad (mapped out by rectangular grid) 256mm x 205mm and the 'Control Program' (Tape or Disc). This includes such features as automatic parallel, vertical, horizontal or diagonal lines, construction of boxes and circles from two probe positions, free hand draw, fill and outline, move and scale, immediate edit and the ability to save completed screens as files or reproduce by line printer.



## B.S.DOLLAMORE LTD.

Burton Road, Burton-on-Trent, Staffs., England.  
Telephone: Burton-on-Trent (0283) 217905.



U.K. Distributor Scientific House, Bridge St.,  
Sandiacre, Notts. Telephone: (0602) 394000.

**£130.39**  
+ VAT



# COMPUTER CITY

THE COMPUTER CAPITAL OF THE NORTH

78 VICTORIA ROAD, WIDNES, CHESHIRE. 051-420 3333

**DISC DRIVES** (including Disc Utilities and Manual)  
 Pace Single 100K Drive ..... £212.25  
 Pace Twin 100K Drive ..... £388.00  
 Acorn Twin 400K Drive (80 Track) ..... £804.00  
 Torch Twin 400K + Z80 & 64K ..... £897.00

**SPECIAL OFFERS**

**PRINTERS**  
 Seikosha GP100A (including free 'Screen Dump' Program) ..... £219.00  
 Seikosha GP250X ... £270.00  
 Epson RX80 ..... £319.00  
 Epson FX80 ..... £455.00  
 Smith Corona TP/1 (Daisywheel) ..... £489.00

**MONITORS**  
 Microvitec 14" Colour Monitor ..... £287.50  
 Sanyo Green Monitor ..... £89.00  
 Sanyo 14" Colour Monitor (Composite) ..... £269.00

**BBC**  
 BBC Model B ..... £399.00  
 BBC Model A ..... £299.00  
 BBC Model A + 16K ..... £338.30  
 BBC Model A + 16K & VIA ..... £345.00

Carriage charges on Micro's, Monitors, Disc Drives and Printers £9.00

- Special Summer Offer -

CASSETTE RECORDER (BBC Compatible) £19.95 P&P £1

NEW - STACK LIGHT PEN including FREE game

(Concentration) £28.75 P&P 50p



**ADVENTURE GAMES FOR THE BBC** Inc. VAT  
 The Golden Baton (A/B) ..... £10.30  
 The Time Machine (A/B) ..... £10.30  
 Arrow of Death (Pt 1) (A/B) ..... £10.30  
 Arrow of Death (Pt 2) (A/B) ..... £10.30  
 Escape from Pulsar 7 (B) ..... £10.30  
 Circus (B) ..... £10.30  
 Feasibility Experiment (B) ..... £10.30  
 The Wizard of Akryz (B) ..... £10.30  
 Perseus and Andromeda (B) ..... £10.30  
 Ten Little Indians (B) ..... £10.30



Star Trek/Candy Floss ..... £6.50  
 Hangman ..... £4.50  
 Super Hangman ..... £4.50  
 Beep Beep ..... £4.50  
 Beebunch ..... £6.50  
 Mutant Invaders ..... £6.50  
 3D Maze ..... £4.50  
 Model A Invaders ..... £5.50  
 Model B Invaders ..... £7.50  
 Word Pro ..... £10.50  
 Atlantis ..... £7.50  
 Flags ..... £4.50  
 Hyper Drive ..... £6.50  
 Strato Bomber ..... £7.50  
 Leap Frog ..... £7.50  
 5-a-Side Soccer ..... £7.50  
 Pontoon and Patience ..... £7.50



Home Finance ..... £10.00  
 Early Learning ..... £10.00  
 Music ..... £10.00  
 The Computer Prog. (Vol. 1) ..... £10.00  
 The Computer Prog. (Vol. 2) ..... £10.00  
 Painting ..... £10.00  
 Drawing ..... £10.00  
 Games of Strategy ..... £10.00  
 Fun Games ..... £10.00



Business Games ..... £9.95  
 Tree of Knowledge ..... £9.95  
 Peeko - Computer/Manual ..... £9.95  
 Algebraic Manipulation ..... £9.95  
 Creative Graphics Cassette\* ..... £9.95  
 Graphs & Charts Cassette\* ..... £9.95  
 Desk Diary/Manual ..... £9.95  
 Lisp Cassette\* ..... £16.85  
 Forth Cassette\* ..... £16.85  
 Philosophers Quest ..... £9.95  
 Sphinx Adventure ..... £9.95  
 Castle of Riddles ..... £9.95  
 Monsters ..... £9.95  
 Snapper ..... £9.95  
 Planetoid ..... £9.95  
 Arcade Action ..... £11.90  
 Rocket Raid\* ..... £9.95  
 Meteors ..... £9.95  
 Arcadians ..... £9.95  
 Sliding Block Puzzles ..... £9.95  
 Cube Master ..... £9.95  
 Super Invaders ..... £9.95  
 Missile Base ..... £9.95  
 Starship Command ..... £9.95  
 Countdown/Doom ..... £9.95  
 Snooker ..... £9.95  
 Number Balance ..... £9.95  
 Word Sequencing ..... £9.95  
 Word Hunt ..... £9.95  
 Missing Signs ..... £9.95

**Quick Silva**  
 Music Processor ..... £14.95  
 Protector ..... £7.95  
 Wizard ..... £6.95

**Simonsoft**  
 Disassembler ..... £6.95

**SPECIAL OFFER**  
 ORDER 2 CASSETTES - DEDUCT £1  
 ORDER 3 CASSETTES - DEDUCT £2 etc.

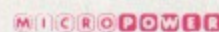

Moonraider (B) ..... £7.99  
 Swoop (B) ..... £7.99  
 Alien Destroyers (B) ..... £7.99  
 Galactic Commander (B) ..... £7.99  
 Timetrek (B) ..... £7.99  
 Laser Command (B) ..... £7.99  
 Spacemaze (B) ..... £6.85  
 Astro Navigator (B) ..... £5.70  
 Maze Invaders (B) ..... £5.70  
 Startrek ..... £5.70  
 Filer ..... £10.30  
 Constellation (B) ..... £6.85  
 Disassembler ..... £6.85  
 Micro Budget ..... £6.85  
 Killer Gorilla (B) ..... £7.99  
 Croaker (B) ..... £7.99  
 Chess (B) ..... £7.99  
 Chess ..... £5.70  
 Barrage (B) ..... £7.99  
 Footer (B) ..... £7.99  
 Labyrinths of Lacoshe (B) ..... £7.99  
 Adventure ..... £7.99  
 Painter (B) ..... £6.85  
 Cowboy Shootout (B) ..... £6.85  
 Munchyman ..... £6.85  
 Caveman Adventure ..... £6.85  
 Seek ..... £6.85  
 Eldorado Gold (B) ..... £6.85  
 Roulette (B) ..... £5.70  
 Reversi 1 ..... £5.70  
 Reversi 2 (B) ..... £5.70  
 Yahtzee (B) ..... £5.70  
 Wall (B) ..... £5.70  
 Mastermind ..... £4.55  
 Draw ..... £10.30  
 Where ..... £6.85  
 Chemistry ..... £6.85  
 World Geography ..... £6.85  
 Junior Maths Pack ..... £6.85  
 Physics ..... £6.85  
 Moon Base Alpha ..... £7.99

**OPUS**  
 Dog Fight ..... £9.95

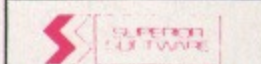

Galaxians ..... £7.95  
 Centipeds ..... £7.95  
 Invaders ..... £7.95  
 Space Fighter ..... £7.95  
 Alien Dropout ..... £7.95  
 Fruit Machine ..... £7.95  
 Frogger ..... £7.95  
 Road Runner ..... £7.95  
 Pontoon ..... £6.95  
 Cribbage ..... £6.95



BBC Supergolf ..... £7.50  
 Bun Fun ..... £6.50



Space Pirates ..... £8.00  
 Space Warp ..... £9.00  
 BBC Dragon Quest ..... £11.50  
 BBC Fruit Machine ..... £5.50  
 BBC Chess ..... £8.00  
 BBC Backgammon ..... £8.00  
 BBC Multitile ..... £15.00  
 Space Invaders ..... £7.50  
 Galaxy Wars ..... £7.50  
 City Defence ..... £7.50  
 Synthesizer ..... £9.50  
 Sea Lord ..... £7.50  
 Oblivion ..... £7.50  
 Old Father Time ..... P.O.A.  
 Graphics Package ..... £9.50  
 Sea Lord ..... £7.50

**LEVEL 9 COMPUTING**

**ULTIMATE ADVENTURES**  
 Colossal Adventure ..... £10.00  
 Adventure Quest ..... £10.00  
 Dungeon Adventure ..... £10.00  
 BBC Forth ..... £15.00  
 BBC Forth Tool Kit ..... £10.00



**BUSINESS SOFTWARE**  
 Cash Book Acc. .... £95.00  
 Beeb Calc ..... £19.95  
 Inv. & Statements ..... £19.95  
 Commercial Acc. .... £19.95  
 Mailing List ..... £19.95  
 Database ..... £19.95  
 Stock Control ..... £19.95  
 Home Accounts ..... £19.95  
 Word Processor ..... £19.95

**Simon Hessel**  
 Great Britain ..... £5.95  
 Inheritance ..... £6.95  
 The World Travel Game ..... £6.95

**WORD PROCESSING**  
 Wordwise ..... £45.00  
 View ..... £59.00

**CREDIT FACILITIES**

Ask about instant credit up to £1,000. Choose the credit to suit you. The deposit is only 10% of the cost of your purchase.

We are credit brokers for Lombard Tricity Finance Ltd. Interest is just 2.25% per month, equivalent to an annual percentage rate of 30.6%. Ask for a written quotation today!

**MAIL ORDER**

Please send me

1 .....  
 2 .....  
 3 .....  
 4 .....  
 5 .....

Postage and packing on software 50p. Phone for hardware delivery rates.

I enclose cheque/P.O. for

OR please debit my Access/Barclaycard/Visa\* .....  
 \* delete as applicable

Card No ..... Expiry date .....

Name .....

Address .....

Code .....

Tel No. ....

Dealers Discount Available  
 ACCESS, BARCLAYCARD VISA ORDERS WELCOME ON  
 24HR 051-420 3333

COMPUTER CITY Dept F. FREEPOST (No Stamp  
 Required) 78 Victoria Road, Widnes, Cheshire WA8 7RA.



TRADE ENQUIRIES WELCOME  
 SPECIAL DEALS FOR SCHOOLS.

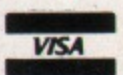

**BOOKS FOR THE BBC MICROCOMPUTER**

1 30 Hour Basic (NEC) ..... £5.50  
 2 Programming the BBC (Newnes) ..... £6.50  
 3 Easy Programming for the BBC Micro (Shivast) ..... £5.95  
 4 Let Your BBC Micro Teach You To Program (Interface) ..... £6.45  
 5 Assembly Language Programming for BBC (MacMillan) ..... £8.95  
 6 BBC: An Expert Guide (Granada) ..... £6.95  
 7 The BBC Micro Revealed (Interface) ..... £7.95  
 8 Programming the 6502 (Sybex) ..... £10.75  
 9 Advanced 6502 Programming (Sybex) ..... £10.25  
 10 Machine Code for Beginners (Sybex) ..... £5.95  
 11 Practical Programs for BBC and Atom (Wiley) ..... £5.95  
 12 30 Programs for the BBC Micro (Evans) ..... £4.95  
 13 Games BBC Computers Play (Addison Wesley) ..... £6.95  
 14 The Book of Listings (BBC Publications) ..... £6.75  
 15 The Computer Book (BBC Publications) ..... £6.75  
 16 Creative Graphics (Acornsoft) ..... £7.50  
 17 Graphs and Charts (Acornsoft) ..... £7.50  
 18 Forth Manual (Acornsoft) ..... £7.50  
 19 Lisp Manual (Acornsoft) ..... £7.50

P & P on Books £1.

THE COMPUTER CAPITAL OF THE NORTH - SUPPLYING BBC MICROCOMPUTERS  
 NATIONWIDE FOR EDUCATION, BUSINESS AND LEISURE

ANOTHER FABULOUS B.B.C. PROGRAM FROM BRITAIN'S LEADING SOFTWARE HOUSE

# Killer Gorilla

Once again, Killer Gorilla holds captive a young and beautiful heiress. Is the age of CHIVALRY dead? Answer the maiden's cries for help and scale the ironwork tower. Race along Girders, Climb Ladders, Jump Gaps, Leap onto moving Elevators and Career along Conveyors. Dodge or jump the rolling barrels or grab a hammer and smash a few. Watch out for the fireballs and iron beams hurled with animal passion. Sensational, full feature machine code arcade game with four phases, increasing difficulty and speed, bonus points and the highest standard of graphics yet achieved on the BBC micro. Only £6.95

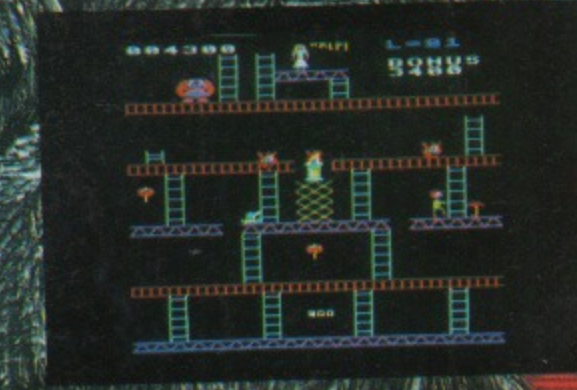
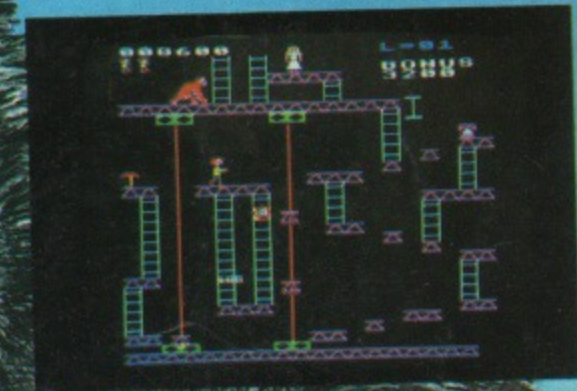
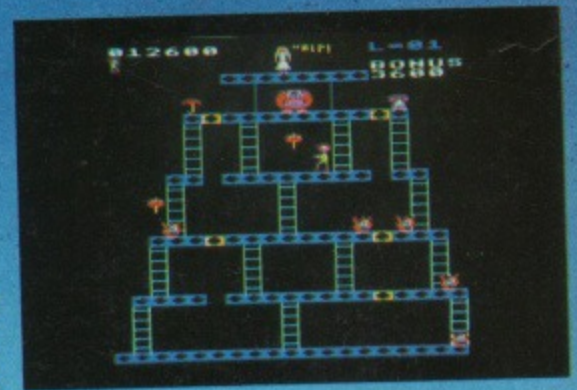

Other programs available: Swoop (B) £6.95/ Croaker (B) £6.95/Chess (B) £6.95/Laser Command (B) £6.95/Galactic Commander (B) £6.95/Filer £8.95/Timerak (B) £6.95/ Micro Budget £6.95/Moonraider (B) £6.95/ Barrage (B) £6.95/Beebmon (B) £6.95/The Labrynth of La Coshe (B) £6.95/Draw (B) £8.95/World Geography (B) £5.95/ Spacemaze (B) £5.95/Munchyman £5.95/ Seek £5.95/Eldorado Gold (B) £5.95/ Disassembler £5.95/Constellation (B) £5.95/ Junior Maths Pack (B) £5.95/Where? (B) £5.95/Painter (B) £5.95/Chemistry (B) £5.95/ Physics (B) £5.95/Caveman Adventure (B) £5.95/Astro Navigator (B) £4.95/Starrek £4.95. Reversi 1 £4.95/Reversi 2 (B) £4.95/Roulette (B) £4.95

Written any Programs? We pay 20% Royalties for B.B.C. & ELECTRON PROGRAMS



WE ARE AUTHORISED DEALERS FOR ACORN ATOM, BBC MICRO & DRAGON 32

**SPECIAL OFFER**

Deduct £1 per cassette when ordering two or more.

MICRO POWER LTD. Dept. BMU8 8/8a REGENT STREET, CHAPEL ALLERTON, LEEDS LS7 4PE

Tel: (0532) 683186 or 696343

Please add 55p order P & P + VAT at 15%



**Please Note:**

All programs are now available at all good dealers or direct from MICRO POWER LTD.



# We go right to the heart of England for the second get-together of BBC Micro Users!

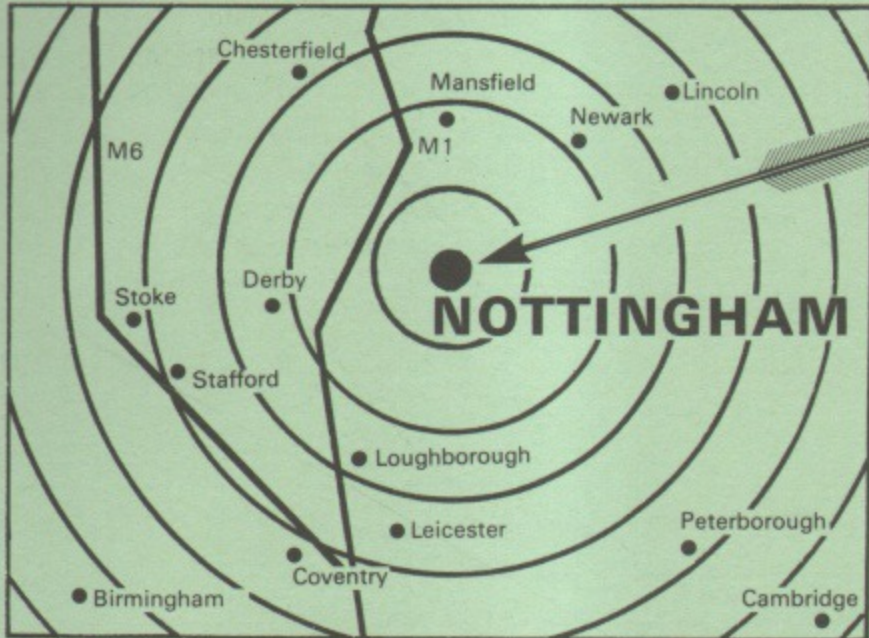

## Sherwood Rooms Nottingham

Friday, Sept 16  
10am - 6pm  
Saturday, Sept 17  
10am - 5pm  
Sunday, Sept 18  
10am - 4pm

***It's another  
action-packed  
3-day event  
that's bang  
on target***

- Try out all the latest games before you buy
- See what's new in add-ons for the BBC Micro
- Put your questions to Britain's top experts



£1

**off normal exhibition  
admission price of £2**

**Sherwood Rooms  
Nottingham**

Friday - Sunday  
September 16 - 18  
1983

Name .....

Address .....

.....

Tel No. ....

Organised by Database Publications

Voucher not valid without above details

petition is a complete  
r - as reviewed in last  
new graphics software.  
ne full potential of BBC  
ed facilities as painting  
mproved image justifi-  
visualise you can draw  
s of the BBC Micro's

program in which your  
arily a ladder), walks to  
into a swimming pool.  
you want. There should  
or example, making the  
a splash as our intrepid

combines realism on one  
BBC Micro's graphic and

cellent article on anima-

If you haven't read the article on Page 16 do it now. It will prove invaluable in helping you with your entry.  
Complete the coupon on this page and send it together with the listing and program on either cassette or disc to the address given.  
Your cassette will be returned provided you enclose a stamped addressed envelope. Otherwise it will be donated to a school.  
If you don't want to cut your copy of *Micro User* you can send a photocopy of the coupon. Closing date for entries is August 31.

### Your FREE entry form

My cassette/disc and listing for the BBC digitiser contest is enclosed.

Name \_\_\_\_\_  
Address \_\_\_\_\_  
\_\_\_\_\_

Tel. No. \_\_\_\_\_  
POST TO: Digitiser Contest, Micro User, Europa House,  
68 Chester Road, Hazel Grove, Stockport SK7 5NY.

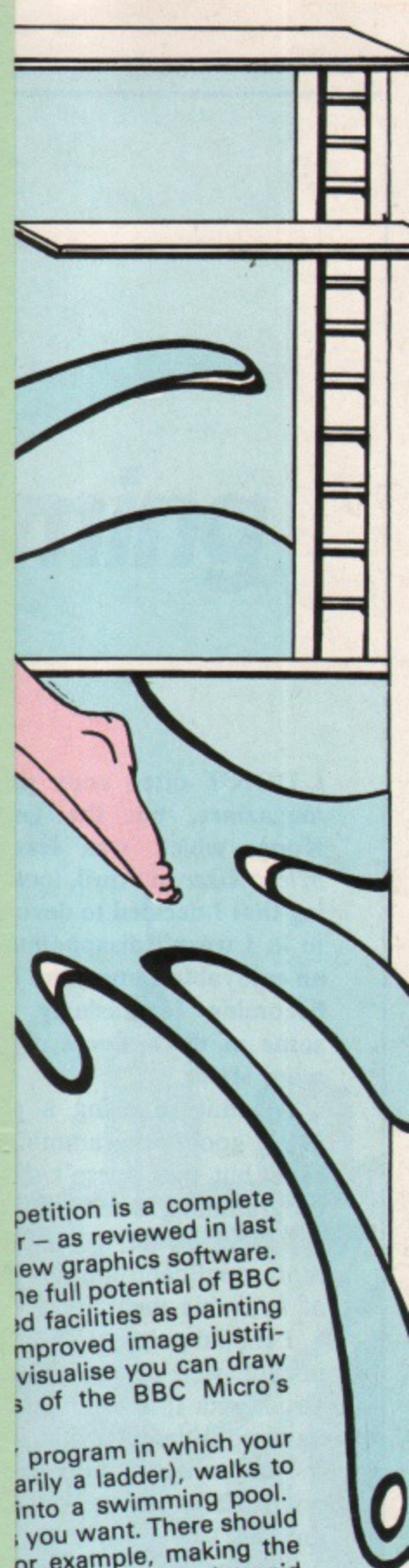
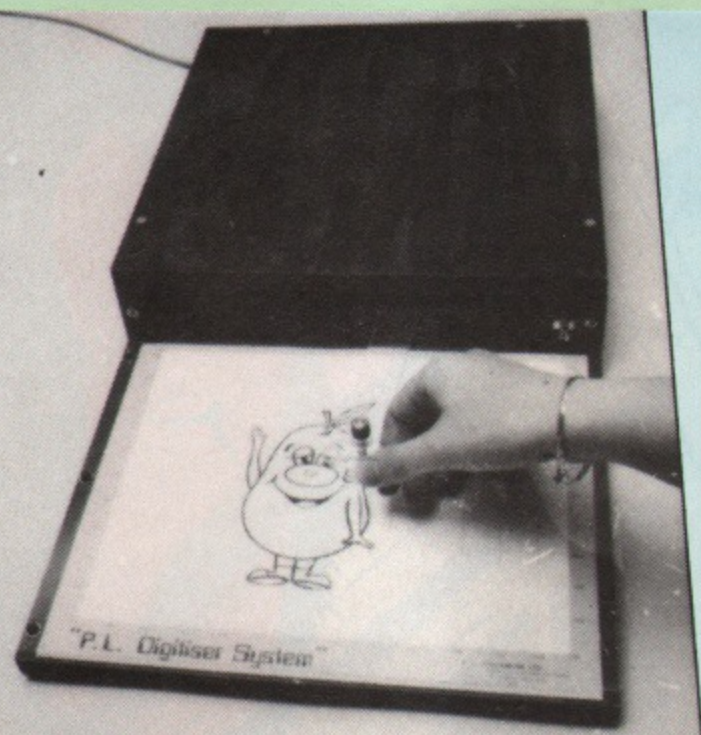

From Page 39

rink whisky or beer.

```

DESIGN
coin = RND(2)
IF coin = 1 THEN
rink whisky
ELSE
rink beer
ENDIF

```

Again, regrettably, although the keyword of BBC Basic is used on a separate line to global structure and open SYNTAX

```

coin = RND(2)
IF coin = 1 THEN PRINT "Whisky" ELSE PRINT "Beer"

```

If the content of each structure is anything more than two statements, clarity and content is best preserved by embodying the content in a procedure.

```

IF coin = 1 THEN PROCbeer
ELSE PROCbeer

```

```
DEF PROCwhisky
```

```
ENDPROC
DEF PROCbeer
```

We need to be careful not to make decisions. The combination of decisions and GOTO statements replace all the structures and procedures, but that does not mean they should.

Let us return to a simple problem of the deputy and the bandit, with the added condition

that if the deputy runs out of ammunition he must retreat.

We might be tempted to use a GOTO statement. Suppose he starts with ammo of 30 bullets.

```

10 shots=0:ammo=30
20 REPEAT
30 gunout=RND(20)
40 PRINT "Fire a shot"
50 shots=shots+1:ammo=ammo-1
60 IF ammo=0 THEN GOTO 100
70 IF shots=6 THEN PROCre_load
80 UNTIL gunout=20
90 PRINT "Bandit throws out gun"
100 REM Out of ammo
110 PRINT "Retreat quickly"
120 END

```

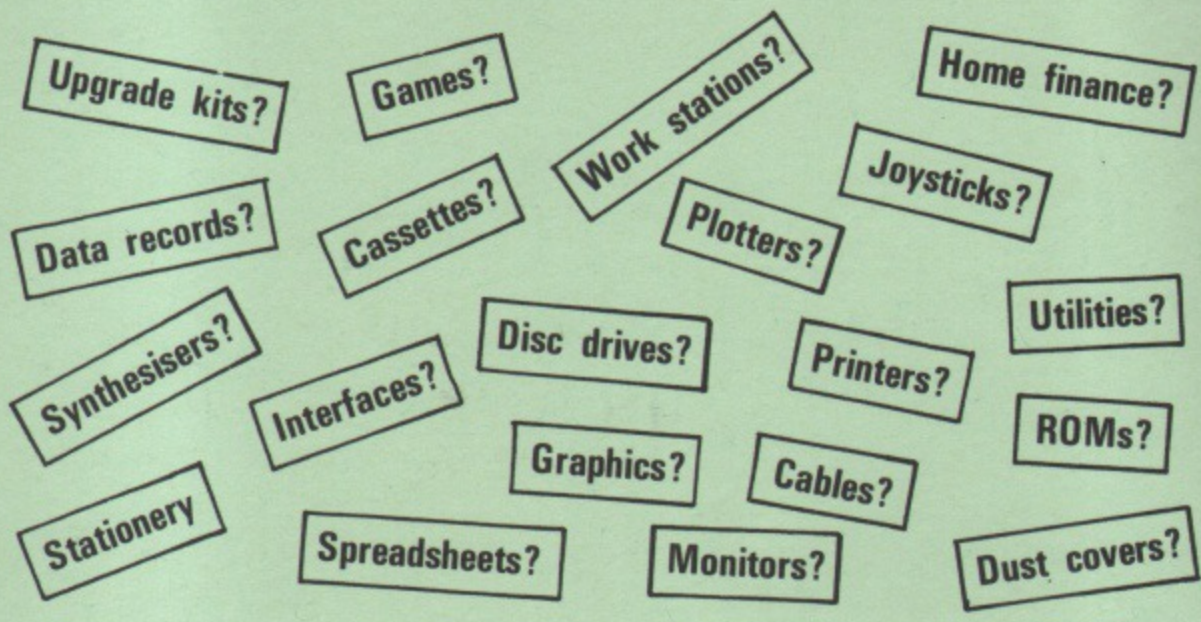

## This is where you'll find the answers to all your questions about the BBC Micro

Now the BBC Micro User Show comes to the Midlands. It's the biggest collection of BBC Micros – plus all the hardware and software that goes with them – that the region has ever seen.

All the major suppliers will be there, displaying all their latest products – some

of which will be on show for the first time.

And in attendance will be leading experts on the BBC Micro, ready and willing to answer all your questions.

If you want to keep fully up to date on all that's new for the BBC Micro, this is a show not to be missed!

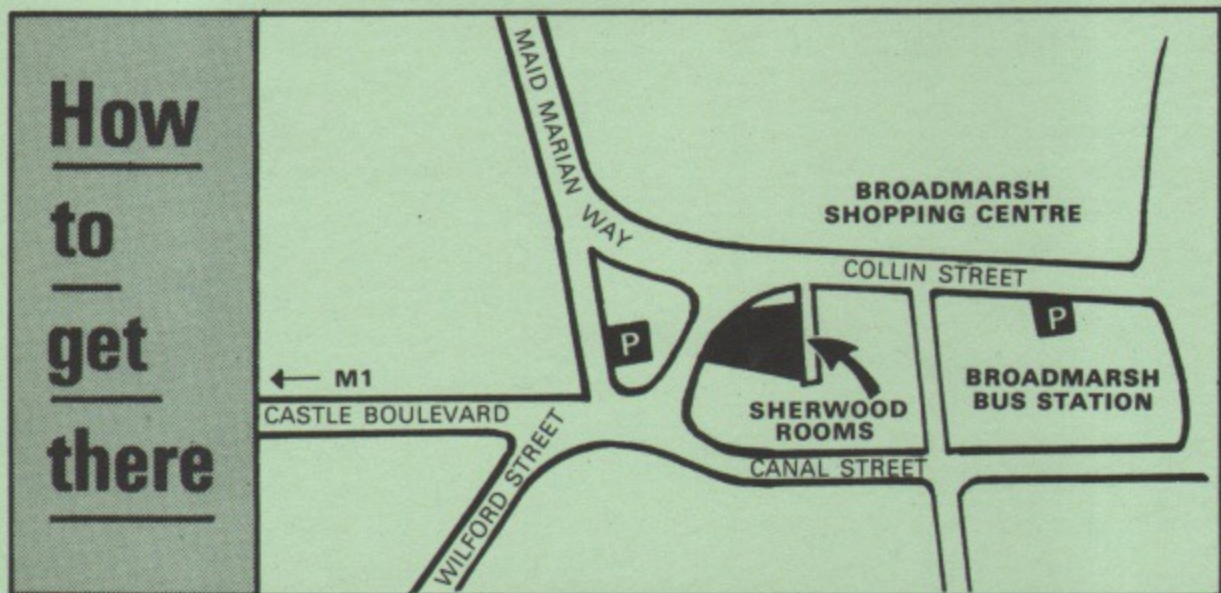

**How to get there**

but we do not know which of the two possibilities is the cause. So we decide using a standard structure.

```

IF out of ammo THEN
Retreat quickly
ELSE
Arrest bandit
ENDIF

```

Thus we keep proper control, and we know that however complex our problem may be it is unlikely that such methods will fail.

More important, the ideas and techniques merge into the powerful blend of problem solving and program design skills.

It is known that beginners (not whizz-kids) can acquire the essentials of good program control in a few

The latter then stand out and help in finding the way around a program, like pubs at street corners help navigation around a city.

This rule also sidesteps some awkward errors which may arise if upper case variable names incorporate, or are the same as, keywords.

These are the essential concepts of program control in BBC Basic and also of sensible problem analysis and program design.

By modern standards they are slightly defective, but, as demonstrated in "Structured Programming with BBC Basic" (Heinemann Education, 1982), with a little care they can support structured programming.

● To be continued

# FREE!

This practical copy-holder to make it easier for you to key in programs, together with a specially designed crib sheet to place vital facts at your fingertips.



**FREE WHEN YOU ORDER A YEAR'S SUBSCRIPTION TO THE MICRO USER ON THE FORM OVERLEAF**

You can also order ...

### Binders and dust covers

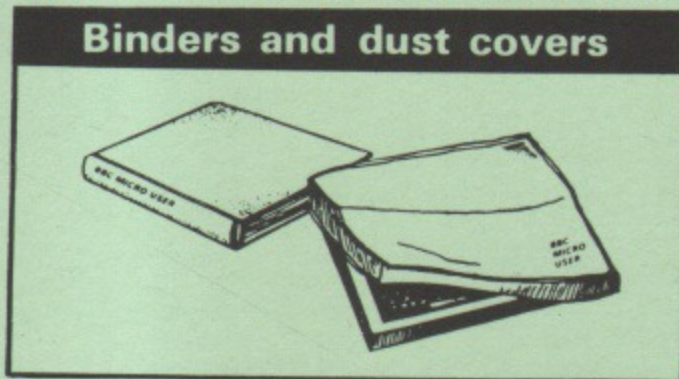

### Back numbers



### Cassette tapes



## ORDER FORM OVERLEAF

Keep your collection of Micro User complete with these handsome binders

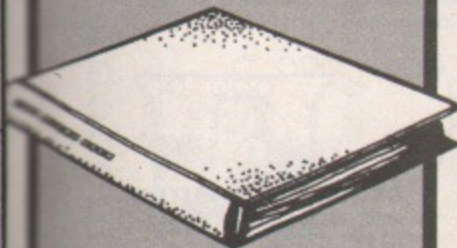

**£3.95**  
(UK)

Your BBC Micro needs protecting!



PVC dust covers  
**£3.25** Standard (beige)  
**£3.95** Deluxe (clear)

## ORDER FORM

Postage, packing and VAT, 30 August 1983.

Please enter number required in box £ p

UK £12   
 EIRE £13   
 EUROPE £18   
 mail - USA £15   
 mail - USA £25   
 rest of world £15   
 rest of world £30

..... issue TOTAL .....

March 1983   
 April 1983   
 May 1983   
 June 1983   
 July 1983

TOTAL .....

### Subscription

..... (state month) TOTAL .....

watch March 1983   
 Kong April 1983   
 Strike May 1983   
 Pilot June 1983   
 Tenpins July 1983   
 Fruities Aug 1983

TOTAL .....

TOTAL .....

TOTAL .....

(Overseas)  
 & Overseas)

Shirt	Sweat Shirt	
White	Blue	White
<input type="checkbox"/>	<input type="checkbox"/>	<input type="checkbox"/>
<input type="checkbox"/>	<input type="checkbox"/>	<input type="checkbox"/>
<input type="checkbox"/>	<input type="checkbox"/>	<input type="checkbox"/>
<input type="checkbox"/>	<input type="checkbox"/>	<input type="checkbox"/>
<input type="checkbox"/>	<input type="checkbox"/>	<input type="checkbox"/>
<input type="checkbox"/>	<input type="checkbox"/>	<input type="checkbox"/>
<input type="checkbox"/>	<input type="checkbox"/>	<input type="checkbox"/>

TOTAL .....

Payment: please indicate method (✓)

TOTAL

Access/Mastercharge/Eurocard  
 Barclaycard/Visa  
 American Express



Card No. \_\_\_\_\_  
 Expiry Date \_\_\_\_\_  
 Cheque/PO made payable to Database Publications Ltd.

Name \_\_\_\_\_

Address \_\_\_\_\_

Signed \_\_\_\_\_

Send to: Micro User, FREEPOST, Europa House, 68 Chester Road, Hazel Grove, Stockport SK7 5NY.  
 (No stamp needed if posted in UK)

Or you can order by phone quoting credit card number and expiry date. **061-456 8383** 9am - 5pm  
**061-456 4157** (subscriptions/back numbers)

# THE MICRO USER

subscription will ensure you get your own personal copy NOT OFF THE PRESSES month after month for the next year.



Copies of these

## ORDER FORM

All prices include postage, packing and VAT and are valid to September 30, 1983

Please enter number required in box

£ p

### The Micro User annual subscription

UK	£12	<input type="checkbox"/>
EIRE	£13	<input type="checkbox"/>
EUROPE	£18	<input type="checkbox"/>
Surface mail - USA	£15	<input type="checkbox"/>
Air mail - USA	£25	<input type="checkbox"/>
Surface mail - Rest of world	£15	<input type="checkbox"/>
Air mail - Rest of world	£30	<input type="checkbox"/>

Commence with ..... issue TOTAL .....

### The Micro User back issues

<input type="checkbox"/>	£1.25 UK	March 1983	<input type="checkbox"/>
<input type="checkbox"/>	Rest of world:	April 1983	<input type="checkbox"/>
<input type="checkbox"/>	£1.50 - Surface	May 1983	<input type="checkbox"/>
<input type="checkbox"/>	£2.50 - Air mail	June 1983	<input type="checkbox"/>
		July 1983	<input type="checkbox"/>

TOTAL .....

### Cassette tape annual subscription

£40 (UK & Overseas)

Commence with ..... tape (state month) TOTAL .....

### Cassette tape single copies

£3.75	Deathwatch	March 1983	<input type="checkbox"/>
	King Kong	April 1983	<input type="checkbox"/>
	Air Strike	May 1983	<input type="checkbox"/>
	Space Pilot	June 1983	<input type="checkbox"/>
	Tenpin	July 1983	<input type="checkbox"/>
	Fruities	Aug 1983	<input type="checkbox"/>

TOTAL .....

### Dust Covers

£3.25	- Standard	<input type="checkbox"/>
£3.95	- De luxe (UK & Overseas)	<input type="checkbox"/>

TOTAL .....

### Binders

£3.95	- UK	<input type="checkbox"/>
£5.00	- Overseas	<input type="checkbox"/>

TOTAL .....

TOTAL .....

Payment: please indicate method (✓)

- Access/Mastercharge/Eurocard
- Barclaycard/Visa
- American Express
- Card No. \_\_\_\_\_
- Expiry Date \_\_\_\_\_
- Cheque/PO made payable to Database Publications Ltd.



Name \_\_\_\_\_

Address \_\_\_\_\_

Signed \_\_\_\_\_

Send to:  
The Micro User,  
FREEPOST,  
Europa House,  
68 Chester Road,  
Hazel Grove,  
Stockport SK7 5NY.  
(No stamp needed if posted in UK)

Or you can order by phone quoting credit card number and expiry date.

**061-456 8383**  
**061-456 4157**  
(subscriptions/back issues)



## Cassette tapes of Micro User programs - £3.75

Or take out a year's subscription and have your cassette posted to you each month. You can start your subscription from any issue to take advantage of this offer.